

# Santech<sup>®</sup>

RM-2014  
Supercedes RM-2009  
2014 © Santech Industries, LLC  
Price \$25.00

## Automotive & Mobile Air Conditioning Compressor Re-Manufacturing Components Catalog



World Class Excellence in Engineered Replacement Components



## Alphabetic Compressor Listing

Compressor	Page	Compressor	Page	Compressor	Page	Compressor	Page	Compressor	Page	Compressor	Page
10P08E	248	10SR17C	292	CVC7P	186	FXA105VSR	438	SC06SA	294	TRS090	506
10P13A	252	150L	420	CWV615	154	FXA105VSS	438	SC08 (Italy)	296	TRS105	510
10P13B	252	150R	422	CWV617	154	FXA105VSSS	438	SC08C (Spain)	296	TRSA09	512
10P13C	252	206	548	CWV618	154	H12A1AH4DX	424	SC08C (USA)	296	TRSA12	512
10P13E	252	209	548	DA6	378	HD6	382	SC206	552	TRSE07	512
10P13F	252	210	548	DCS17	554	HG1000	530	SC209	552	TV10CA	300
10P15C	252	5SE09C	194	DCS17E	554	HG500	528	Scroll	372	TV10CB	300
10P15E	252	5SE12C	198	DCS17EC	554	HG850	530	SCS06C	294	TV12C(R12)	302
10P15F	252	5SL12	201	DCS17IC	556	HR6	378	SCSA06	298	TV12C(R134)	304
10P17	256	5SL12CJ	201	DCV11A	312	HR6HE	378	SCSC06	298	TV12EC(R12)	306
10P17C	256	5SL142	201	DCV11D	315	HS090L	538	SD505	468	TV12SC(R134)	310
10P17VC	256	6C17	164	DCV14A	312	HS090R	538	SD507	472	TV14C	302
10PA15A	260	6CA17C	202	DCV14J	316	HS110R	538	SD507A2	472	TV14EC	306
10PA15C	260	6E171	204	DCW17B	318	HS15	532	SD508	472	TV14SC	310
10PA15E	260	6E171A	204	DCW17D	318	HS17	534	SD510	472	V5	394
10PA15L	260	6P127A	208	DKS13CH	320	HS18	534	SD5H09	476	V5 (Citroen)	394
10PA15LC	260	6P127B	208	DKS13G (Dual)	322	HT6	382	SD5H11	476	V5 (Daewoo)	174
10PA15SC	260	6P127D	208	DKS13G (Singl)	324	HU6	386	SD5H13	476	V5 (Destroker)	394
10PA15VC	264	6P134	212	DKS13S	326	Large Scroll	371	SD6V12	480	V5-15C	160
10PA15VL	268	6P148	216	DKS15BH	328	MJ110	408	SD708	482	V5-15F	160
10PA17A	260	6P148A	216	DKS15CH	330	MJ123	410	SD709	482	V5-15G	160
10PA17C	260	6P148C	216	DKS15G	332	MJ167	412	SD709CA	486	V7	398
10PA17E	260	6SEU12	220	DKS15S	334	MJS130	414	SD709CP	488	V7 (Destroker)	398
10PA17H	260	6SEU12C	224	DKS16H(R12)	336	MJS170	416	SD7B10	490	VIR	402
10PA17J	260	6SEU14C	224	DKS16H(R134)	338	MSC105CVS	448	SD7C16	492	VS12M	540
10PA17K	260	6SEU16	226	DKS17CH	340	MSC105VSR	448	SD7H13	494	VS16	542
10PA17SC	270	6SEU16C	226	DKS17D	342	MSC130CVSG	450	SD7H15	496	VS16N	544
10PA17SH	272	7SB16C	230	DKS17DS	344	MSC130CVSG	450	SD7V16	500	VS18	546
10PA17VC	264	7SBH17C	232	DKS17G (Dual)	346	MSC90	446	SP10	188	VS18M	546
10PA17VL	268	7SBU16C	234	DKS17G (Singl)	348	MSC90C	446	SP15	192	Wingcell	146
10PA17VSC	264	7SBU17C	236	DKS17S	350	N1300AC4	426	SP17	192		
10PA20	274	7SE16	238	DKV11A	312	N1301A0AH4	430	SS10LV6	516		
10PA20C	274	7SEU16	240	DKV11D	315	N1301AB4	430	SS10V1	516		
10PA20H	274	7SEU16C	240	DKV11G	352	N1301AD4	430	SS10V6	516		
10PA20J	274	7SEU17C	244	DKV14B	452	N1301AE4	430	SS121DN1	520		
10PA20SC	278	A5000	406	DKV14C	454	NL1300AA4	426	SS121DN2	520		
10PA20SH	280	A590	168	DKV14D	158	NL1300AB4	426	SS121DV2	520		
10PA20VC	282	A6	374	DKV14G	352	NL1300AE4	426	SS170PSS	522		
10S11C	284	AX105VSL	438	DKV14J	316	NVR140S	456	SS96D1	518		
10S11P	284	AX105VSR	438	F500	354	PXE13	458	SS96D2	518		
10S13C	284	Axial	148	FS10	360	PXE16	462	SWP123	418		
10S13P	284	C171	168	FS18	364	PXV16	466	SWP167	418		
10S15C	288	CR14	150	FS20	366	R4	390	TM08	526		
10S15L	288	CSV613	152	FS6	356	RC17D	404	TM08HD	526		
10S17C	288	CVC-125	178	FS6 (Cross Mo)	356	RC17S	404	TR090	506		
10S17F	288	CVC-135	178	FX105V	442	RV2	172	TR105	510		
10S20C	288	CVC-135E	182	FX15	368	S1150AE4	434	TR105VS	510		
10S20F	288	CVC-165	186	FX80	440	S1150F3	434	TR70	504		
10S20H	288	CVC-185	186	FXA105VS	438	S1150X3	434	TRF090	506		
10SR15C	292	CVC6	178	FXA105VSLR	438	SA1150AE4	436	TRF105	510		



## Table of Contents

### Charts

Bearing Chart	5
Oil Chart	8
Adjustable Shaft Seal Protector Chart	11
Pad and Plate Chart	12
O-Rings and Lathe Cuts Dimensional Size C	16
O-Rings and Lathe Cuts Visual Size Chart	20
Sealing Washer Chart	30
Shims Chart	34

### Bulk Section

Bearings	38
Chemicals	42
Clutch Components	44
Control Valves	53
Electrical	55
Fasteners	57
Fastener Kits	69
Gaskets	66
Gasket Kits	78
Hard Components	93
O-Rings and Lathe Cuts	94
Piston Components	111
Reeds and Valve Plates	114
Service Items	116
Shaft Seals	121
Shaft Seal Kits	123
Shipping Closures	129
Tools	134

### Behr

Wingcell	142
----------	-----

### Bosch

Axial	144
-------	-----

### Calsonic

CR14	146
CSV613	148
CWV	150
DKV14D	154
V5-15	156

### Chrysler

6C17	160
A590/C171	164

### Chrysler

RV2	168
-----	-----

### Daewoo

V5	170
----	-----

### Delphi

CVC-125/CVC-135	174
CVC135E	178
CVC-165/CVC-185	182
SP10	184
SP15/17	188

### Denso

5SE09C	190
5SE12C	194
5SL	197
6CA17	198
6E171	200
6P127	204
6P134	208
6P148	212
6SEU12	216
6SEU12-14C	220
6SEU16	222
7SB16	226
7SBH17C	228
7SBU16	230
7SBU17C	232
7SE16	234
7SEU16	236
7SEU17C	240
10P08	244
10P13/10P15	248
10P17	252
10PA15/10PA17	256
10PA15VC/10PA17VC	260
10PA15VL	264
10PA17SC	266
10PA17SH	268
10PA20	270
10PA20SC	274
10PA20SH	276
10PA20VC	278
10S11/10S13	280

## Table of Contents

### Denso

10S15/10S17/10S20	284
10SR15/17/20	288
SC06C	290
SC08	292
SCSC06	294
TV10C	296
TV12C(R12)/TV14C	298
TV12C(R134a)	300
TV12EC(R12)/TV14EC	302
TV12SC(R134a)/TV14SC	306

### Diesel Kiki

DCV11A/DCV14A/DKV11A	308
DCV11D/DKV11D	311
DCV14J/DKV14J	312
DCW17	314
DKS13CH	316
DKS13G(Dual)	318
DKS13G(Single)	320
DKS13S	322
DKS15BH	324
DKS15CH	326
DKS15G	328
DKS15S	330
DKS16H(R12)	332
DKS16H(R134a)	334
DKS17CH	336
DKS17D	338
DKS17DS	340
DKS17G(Dual)	342
DKS17G(Single)	344
DKS17S	346
DKV11G/DKV14G	348

### Ford

F500	350
FS6	352
FS10	356
FS18	360
FS20	362
FX15	364
Large Scroll	367
Scroll	368

### GM/Harrison

A6	370
DA6/HR6/HR6HE	374
HD6/HT6	378
HU6	382
R4	386
V5	390
V7	394
VIR	398

### Hadsys

RC17	400
------	-----

### Hitachi

A5000	402
MJ110	404
MJ123	406
MJ167	408
MJS130	410
MJS170	412
SWP123/SWP167	414

### Keihin

150L	416
150R	418

### Mats/Pan

H12A1AH4DX	420
N1300/NL1300	422
N1301	426
S1150	430
SA1150	432

### Mitsubishi

AX105/FXA105	434
FX80	436
FX105	438
MSC90	442
MSC105	444
MSC130CVSG	446

### Nihon

DKV14B	448
DKV14C	450
NVR140	452

### Sanden

PXE13	454
-------	-----

## Table of Contents

### Sanden

<u>PXE16</u>	458
<u>PXV16</u>	462
<u>SD505</u>	464
<u>SD507/SD508/SD510</u>	468
<u>SD5H09/SD5H11/SD5H13</u>	472
<u>SD6V12</u>	476
<u>SD708/SD709</u>	478
<u>SD709CA</u>	482
<u>SD709CP</u>	484
<u>SD7B10</u>	486
<u>SD7C16</u>	488
<u>SD7H13</u>	490
<u>SD7H15</u>	492
<u>SD7V16</u>	496
<u>TR70</u>	500
<u>TR090</u>	502
<u>TR105</u>	506
<u>TRSA/E</u>	508

### Zexel

<u>DCS17E</u>	550
<u>DCS17IC</u>	552

### Seiko-Seiki

<u>SS10</u>	512
<u>SS96</u>	514
<u>SS121</u>	516
<u>SS170</u>	518

### Tama

<u>TM08</u>	522
-------------	-----

### Tecumseh

<u>HG500</u>	524
<u>HG850/HG1000</u>	526

### Visteon

<u>HS15</u>	528
<u>HS17/HS18</u>	530
<u>HS090</u>	534
<u>VS12M</u>	536
<u>VS16</u>	538
<u>VS16N</u>	540
<u>VS18</u>	542

### York

<u>206/209/210</u>	544
<u>SC206/SC209</u>	548

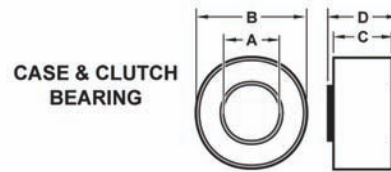
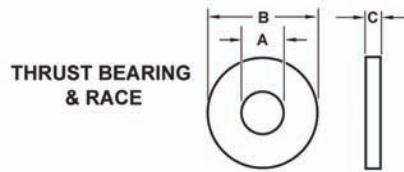

## Bearings

Case Bearings	Inches			Millimeters		
	A ID	B OD	C Length	A ID	B OD	C Length
B10-2110	0.630	0.906	0.862	16.00	23.00	21.90
B11-2101	0.984	2.205	0.591	25.00	56.00	15.00
B11-2110	0.642	0.866	0.703	16.30	22.00	17.85
B12-3103	0.634 Shaft Bushing	0.713	0.787	16.10	18.10	20.00
B13-2111	0.748	1.031	0.492	19.00	26.20	12.50
B13-2120	0.563	0.752	0.618	14.30	19.10	15.70
B13-2130	0.626	0.827	0.492	15.90	21.00	12.50
B13-2132	0.626	0.839	0.500	15.90	21.30	12.70
B13-2133	0.563	0.811	0.618	14.30	20.60	15.70
B13-2134	0.626	0.878	0.622	15.90	22.30	15.80
B13-2135	0.657 Shaft Bushing	0.748	0.787	16.70	19.00	20.00
B20-2000	0.591	0.906	0.630	15.00	23.00	16.00
B20-2110	0.630	0.906	0.630	16.00	23.00	16.00
B25-2110	0.787	1.067	1.181	20.00	27.10	30.00
B25-2111	0.472	1.102	0.315	12.00	28.00	8.00
B25-2112	0.394	1.024	0.315	10.00	26.00	8.00
B25-2113	0.630	0.866	0.630	16.00	22.00	16.00
B25-2114	0.394	1.102	0.315	10.00	28.00	8.00
B30-2000	0.630	0.866	0.787	16.00	22.00	20.00
B40-2110	0.669	1.575	0.472	17.00	40.00	12.00
B40-2112	1.181	2.441	0.445	30.00	62.00	11.30

Clutch Bearings	Inches				Millimeters			
	A ID	B OD	C Outer Race	D Inner Race	A ID	B OD	C Outer Race	D Inner Race
B10-1105	1.181	2.441	0.630	0.945	30.00	62.00	16.00	24.00
B10-1107	1.378	2.165	0.787		35.00	55.00	20.00	
B10-1110	1.575	2.441	0.811	0.945	40.00	62.00	20.60	24.00
B11-1100	1.181	2.441	1.063		30.00	62.00	27.00	
B12-1120	1.181	2.165	0.906		30.00	55.00	23.00	
B13-1110	1.575	2.441	0.811		40.00	62.00	20.60	
B20-1105	1.496	2.126	0.669		38.00	54.00	17.00	
B20-1106	1.181	2.047	0.866		30.00	52.00	22.00	
B20-1107	1.575	2.244	0.787	0.945	40.00	57.00	20.00	24.00
B20-1108	1.378	2.047	0.866		35.00	52.00	22.00	
B20-1109	1.378	2.047	0.787		35.00	52.00	20.00	
B20-1110	1.181	2.047	0.787		30.00	52.00	20.00	
B20-1112	1.181	1.850	0.787		30.00	47.00	20.00	
B20-1113	1.181	1.850	0.472		30.00	47.00	12.00	
B20-1115	1.378	2.047	0.472		35.00	52.00	12.00	
B20-1906	1.181	2.047	0.866		30.00	52.00	22.00	
B25-1100	1.575	2.441	0.945		40.00	62.00	24.00	

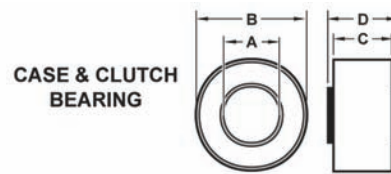
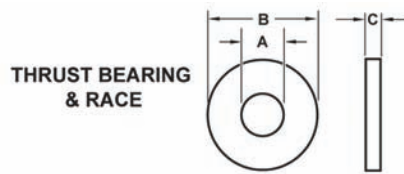

## Bearings

Clutch Bearings	Inches				Millimeters				
	Part No	A ID	B OD	C Outer Race	D Inner Race	A ID	B OD	C Outer Race	D Inner Race
B25-1101	1.181	1.850	0.709			30.00	47.00	18.00	
B25-1102	1.378	1.969	0.787			35.00	50.00	20.00	
B25-1103	1.260	1.850	0.709			32.00	47.00	18.00	
B25-1104	1.378	1.890	0.787			35.00	48.00	20.00	
B30-1120	1.378	2.441	1.102			35.00	62.00	28.00	
B30-1121	1.575	2.677	1.181			40.00	68.00	30.00	
B40-2114	1.181	2.441	0.630			30.00	62.00	16.00	
B50-1100	1.260	2.165	0.906			32.00	55.00	23.00	
B55-1100	1.575	2.598	0.945			40.00	66.00	24.00	
B70-1100	1.378	2.441	0.945			35.00	62.00	24.00	
B70-1101	1.378	2.165	0.866			35.00	55.00	22.00	
B95-1102	1.575	2.244	0.945			40.00	57.00	24.00	

Thrust Bearing Needles	Inches		Millimeters		
	Part No	B OD	D Length	B OD	D Length
B13-3115		0.126	0.736	3.20	18.70

Thrust Bearing Sets	Inches			Millimeters			
	Part No	A ID	B OD	C Thick	A ID	B OD	C Thick
B13-6100	2.193	3.028	0.187				
B13-6101	2.130	3.024	0.187				
	Protruding Inner Race						
B20-6100	0.394	0.980	0.157	10.00	24.90	3.98	
B25-6101-25	2.685	3.614	0.189	68.20	91.80	4.80	
B25-6102-25	2.185	2.799	0.189	55.50	71.10	4.80	
B25-6103-25	2.437	3.291	0.196	61.90	83.60	4.99	

Thrust Bearings	Inches			Millimeters			
	Part No	A ID	B OD	C Thick	A ID	B OD	C Thick
B13-3105	0.579	1.467	0.094	14.70	37.25	2.40	
B13-3106	0.630	1.378	0.189	16.00	35.00	4.80	
B13-3107	0.630	1.299	0.157	16.00	33.00	4.00	
B13-3110	0.756	1.465	0.079	19.20	37.20	2.00	
B13-3121	0.579	1.606	0.118	14.70	40.80	3.00	
B13-3122	2.965	3.929	0.157	75.30	99.80	4.00	
B20-3115	0.681	1.339	0.118	17.30	34.00	3.00	
B20-3127	0.669	1.339	0.094	17.00	34.00	2.40	
B25-3110	2.252	3.126	0.126	57.20	79.40	3.20	
B25-3115	2.760	3.539	0.126	70.10	89.90	3.20	
B65-3110	0.791	1.366	0.079	20.10	34.70	2.00	
B75-3100	1.772	2.559	0.118	45.00	65.00	3.00	



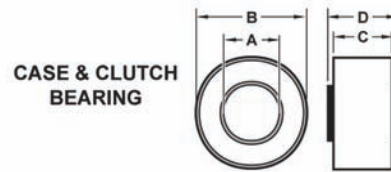
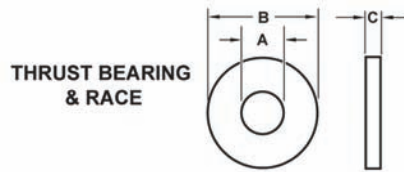

## Bearings

Thrust Races	Inches			Millimeters		
	A ID	B OD	C Thick	A ID	B OD	C Thick
B10-4101	0.677	1.665	0.106	17.20	42.30	2.70
B10-4102	0.677	1.665	0.107	17.20	42.30	2.71
B10-4109	0.677	1.677	0.109	17.20	42.60	2.77
B13-4110	0.760	1.469	0.092	19.30	37.30	2.34
B13-4117	0.760	1.469	0.102	19.30	37.30	2.58
B13-4118	0.760	1.469	0.102	19.30	37.30	2.60
B13-4132	0.575	1.453	0.084	14.60	36.90	2.13
B13-4134	0.575	1.453	0.086	14.60	36.90	2.19
B13-4135	0.575	1.453	0.087	14.60	36.90	2.21
B13-4139	0.575	1.453	0.090	14.60	36.90	2.29
B13-4144	2.878	3.937	0.032	73.10	100.00	0.81
	Protruding Inner Race (OD: 75.16mm) & 2 Inner Tangs					
B20-4100	0.669	1.339	0.088	17.00	34.00	2.24
B20-4101	0.669	1.457	0.088	17.00	37.00	2.24
B65-4100	0.799	1.409	0.091	20.30	35.80	2.30

## Oil Chart

Compressor Manufacturer	Compressor Type	OEM Oil	Oil Viscosity	Can 8 oz	Can Quart	Drum 55 Gallon
BEHR	WINGCELL	ISO100	100	MT3013	MT3019	A10-6164
BOSCH	AXIAL	ND8	46	MT3012	MT3018	A10-6163
CALSONIC	CR14		100	MT3013	MT3019	A10-6164
CALSONIC	CSV613		150	MT3014	MT3020	A10-6165
CALSONIC	CWV	KLHOO-PAGS0	100	MT3013	MT3019	A10-6164
CALSONIC	DKV14D	ZXL200PG	100	MT3013	MT3019	A10-6164
CALSONIC	V5-15	D90 PX	46	MT3012	MT3018	A10-6163
CHRYSLER	6C17	ND8	46	MT3012	MT3018	A10-6163
CHRYSLER	A590-C171	ND8	46	MT3012	MT3018	A10-6163
CHRYSLER	RV2	ISO46	46	MT3012	MT3018	A10-6163
DAEWOO	V5(D)		100	MT3013	MT3019	A10-6164
DELPHI	CVC125-135	PAG B0401059	150	MT3014	MT3020	A10-6165
DELPHI	CVC135E	PAG 9986181	150	MT3014	MT3020	A10-6165
DELPHI	CVC165-185	PAG B0401059	46	MT3012	MT3018	A10-6163
DELPHI	SP10	UCON 244	100	MT3013	MT3019	A10-6164
DELPHI	SP15-17	RL897	46	MT3012	MT3018	A10-6163
DENSO	10P08	ND8	46	MT3012	MT3018	A10-6163
DENSO	10P13-15	ND8	46	MT3012	MT3018	A10-6163
DENSO	10P17	ND8	46	MT3012	MT3018	A10-6163
DENSO	10PA15-17	ND8	46	MT3012	MT3018	A10-6163
DENSO	10PA15VC-17VC	ND8	46	MT3012	MT3018	A10-6163
DENSO	10PA15VL-17VL	ND8	46	MT3012	MT3018	A10-6163
DENSO	10PA17SC	ND8	46	MT3012	MT3018	A10-6163
DENSO	10PA17SH	ND8	46	MT3012	MT3018	A10-6163
DENSO	10PA20	ND8	46	MT3012	MT3018	A10-6163
DENSO	10PA20SC	ND8	46	MT3012	MT3018	A10-6163
DENSO	10PA20SH	ND8	46	MT3012	MT3018	A10-6163
DENSO	10PA20VC	ND8	46	MT3012	MT3018	A10-6163
DENSO	10S11-13	ND8	46	MT3012	MT3018	A10-6163
DENSO	10S15-17-20	ND8	46	MT3012	MT3018	A10-6163
DENSO	10SR15-17-20	ND8	46	MT3012	MT3018	A10-6163
DENSO	5SE09C	ND-OIL8	46	MT3012	MT3018	A10-6163
DENSO	5SE12C	ND-OIL8	46	MT3012	MT3018	A10-6163
DENSO	5SL	ND8	100	MT3013	MT3019	A10-6164
DENSO	6CA17C	ND-OIL8	46	MT3012	MT3018	A10-6163
DENSO	6E171	ND8	46	MT3012	MT3018	A10-6163
DENSO	6P127	ND8	46	MT3012	MT3018	A10-6163
DENSO	6P134	ND8	46	MT3012	MT3018	A10-6163
DENSO	6P148	ND8	46	MT3012	MT3018	A10-6163
DENSO	6SEU12		46	MT3012	MT3018	A10-6163
DENSO	6SEU12-14C		46	MT3012	MT3018	A10-6163
DENSO	6SEU16	ND8	46	MT3012	MT3018	A10-6163
DENSO	7SB16C	ND8	46	MT3012	MT3018	A10-6163
DENSO	7SBU16C	ND8	46	MT3012	MT3018	A10-6163
DENSO	7SE16	ND8	46	MT3012	MT3018	A10-6163
DENSO	7SEU16		46	MT3012	MT3018	A10-6163
DENSO	7SEU17C		46	MT3012	MT3018	A10-6163
DENSO	SC08	ND8	46	MT3012	MT3018	A10-6163
DENSO	SCS06C	ND8	46	MT3012	MT3018	A10-6163
DENSO	SCSC06		46	MT3012	MT3018	A10-6163

## Oil Chart

Compressor Manufacturer	Compressor Type	OEM Oil	Oil Viscosity	Can 8 oz	Can Quart	Drum 55 Gallon
DENSO	TV10CA	ND9	100	MT3013	MT3019	A10-6164
DENSO	TV12C(R12)	ND9	100	MT3013	MT3019	A10-6164
DENSO	TV12C(R134)	ND9	100	MT3013	MT3019	A10-6164
DENSO	TV12EC(R12)	ND9	100	MT3013	MT3019	A10-6164
DENSO	TV12SC(R134)	ND9	100	MT3013	MT3019	A10-6164
DIESEL KIKI	DCV11-14	ZXL200PG	100	MT3013	MT3019	A10-6164
DIESEL KIKI	DCV11D-DKV11D		150	MT3014	MT3020	A10-6165
DIESEL KIKI	DCV11D-DKV11D	DH-PR	150	MT3014	MT3020	A10-6165
DIESEL KIKI	DCV14J-DKV14J	ZXL200PG	100	MT3013	MT3019	A10-6164
DIESEL KIKI	DCW17D	ZXL100PG	46	MT3012	MT3018	A10-6163
DIESEL KIKI	DKS13CH	SUSO 5GS	46	MT3012	MT3018	A10-6163
DIESEL KIKI	DKS13G(DUAL)	SUSO 5GS	46	MT3012	MT3018	A10-6163
DIESEL KIKI	DKS13G(SINGLE)	SUSO 5GS	46	MT3012	MT3018	A10-6163
DIESEL KIKI	DKS13S	DS83P	100	MT3013	MT3019	A10-6164
DIESEL KIKI	DKS15BH	DS83P	100	MT3013	MT3019	A10-6164
DIESEL KIKI	DKS15CH	ZXL100PG	46	MT3012	MT3018	A10-6163
DIESEL KIKI	DKS15G	ZXL200PG	100	MT3013	MT3019	A10-6164
DIESEL KIKI	DKS15S	DS83P	100	MT3013	MT3019	A10-6164
DIESEL KIKI	DKS16H(R12)	DS83P	100	MT3013	MT3019	A10-6164
DIESEL KIKI	DKS16H(R134)	KLHOO-PAGS0	100	MT3013	MT3019	A10-6164
DIESEL KIKI	DKS17CH		46	MT3012	MT3018	A10-6163
DIESEL KIKI	DKS17D		46	MT3012	MT3018	A10-6163
DIESEL KIKI	DKS17G(DUAL)	SUNISO-5GS	46	MT3012	MT3018	A10-6163
DIESEL KIKI	DKS17G(SINGLE)	SUNISO-5GS	46	MT3012	MT3018	A10-6163
DIESEL KIKI	DKS17S	DS83P	100	MT3013	MT3019	A10-6164
DIESEL KIKI	DKV11-14G	ZXL200PG	100	MT3013	MT3019	A10-6164
FORD	F500		46	MT3012	MT3018	A10-6163
FORD	FS10	YN-12	46	MT3012	MT3018	A10-6163
FORD	FS6	ND8	46	MT3012	MT3018	A10-6163
FORD	FX15	YN-12	46	MT3012	MT3018	A10-6163
FORD	LARGE SCROLL		46	MT3012	MT3018	A10-6163
FORD	SCROLL		46	MT3012	MT3018	A10-6163
GM/HARRISON	A6	UCON 488	150	MT3014	MT3020	A10-6165
GM/HARRISON	DA6-HR6-HR6HE	UCON 488	150	MT3014	MT3020	A10-6165
GM/HARRISON	HD6-HT6	UCON 488	150	MT3014	MT3020	A10-6165
GM/HARRISON	HU6	UCON 488	150	MT3014	MT3020	A10-6165
GM/HARRISON	R4	UCON 488	150	MT3014	MT3020	A10-6165
GM/HARRISON	V5	UCON 488	150	MT3014	MT3020	A10-6165
GM/HARRISON	V7	UCON 488	150	MT3014	MT3020	A10-6165
HADSYS	RC17	ND8	46	MT3012	MT3018	A10-6163
HITACHI	A5000	KLHOO-PAGS1	46	MT3012	MT3018	A10-6163
HITACHI	MJ110	KLHOO-PAGS1	46	MT3012	MT3018	A10-6163
HITACHI	MJ123	KLHOO-PAGS1	46	MT3012	MT3018	A10-6163
HITACHI	MJ167	KLHOO-PAGS1	46	MT3012	MT3018	A10-6163
HITACHI	MJS130	KLHOO-PAGS1	46	MT3012	MT3018	A10-6163
HITACHI	MJS170	KLHOO-PAGS1	46	MT3012	MT3018	A10-6163
HITACHI	SWP123-167	KLHOO-PAGS1	46	MT3012	MT3018	A10-6163
KEIHIN	150L		100	MT3013	MT3019	A10-6164
KEIHIN	150R		100	MT3013	MT3019	A10-6164
MATS/PAN	H12A1AH4DX	ATMOS-GU10	46	MT3012	MT3018	A10-6163

## Oil Chart

Compressor Manufacturer	Compressor Type	OEM Oil	Oil Viscosity	Can 8 oz	Can Quart	Drum 55 Gallon
MATS/PAN	N1301	PAG56	46	MT3012	MT3018	A10-6163
MATS/PAN	NL1300	PAG56	46	MT3012	MT3018	A10-6163
MATS/PAN	S1150	PAG56	46	MT3012	MT3018	A10-6163
MATS/PAN	SA1150AE	PAG56	46	MT3012	MT3018	A10-6163
MITSUBISHI	FX105V	PAG56	46	MT3012	MT3018	A10-6163
MITSUBISHI	FX80	PAG56	46	MT3012	MT3018	A10-6163
MITSUBISHI	FXA105	PAG56	46	MT3012	MT3018	A10-6163
MITSUBISHI	MSC105	PAG56	46	MT3012	MT3018	A10-6163
MITSUBISHI	MSC105		46	MT3012	MT3018	A10-6163
MITSUBISHI	MSC130CVSG		46	MT3012	MT3018	A10-6163
MITSUBISHI	MSC90	PAG56	46	MT3012	MT3018	A10-6163
NIHON	DKV14B	ZXL200PG	100	MT3013	MT3019	A10-6164
NIHON	DKV14C	KLHOO-PAGR1	100	MT3013	MT3019	A10-6164
NIHON	NVR140S	D90 PX	46	MT3012	MT3018	A10-6163
SANDEN	PXE13	SP10	46	MT3012	MT3018	A10-6163
SANDEN	PXE16	SP10	46	MT3012	MT3018	A10-6163
SANDEN	SD505	SP20	100	MT3013	MT3019	A10-6164
SANDEN	SD507-508-510	SP20	100	MT3013	MT3019	A10-6164
SANDEN	SD5H13	SP20	100	MT3013	MT3019	A10-6164
SANDEN	SD6V12	SP20	100	MT3013	MT3019	A10-6164
SANDEN	SD708-709	SP20	100	MT3013	MT3019	A10-6164
SANDEN	SD709CA	SP20	100	MT3013	MT3019	A10-6164
SANDEN	SD709CP	SP20	100	MT3013	MT3019	A10-6164
SANDEN	SD7B10	SP20	100	MT3013	MT3019	A10-6164
SANDEN	SD7C16	SP10	46	MT3012	MT3018	A10-6163
SANDEN	SD7H13	SP20	100	MT3013	MT3019	A10-6164
SANDEN	SD7H15	SP20	100	MT3013	MT3019	A10-6164
SANDEN	SD7V16	SP20	100	MT3013	MT3019	A10-6164
SANDEN	TR090	SP10	46	MT3012	MT3018	A10-6163
SANDEN	TR105	SP10	46	MT3012	MT3018	A10-6163
SANDEN	TR70	SP10	46	MT3012	MT3018	A10-6163
SANDEN	TRSAE	SP10	46	MT3012	MT3018	A10-6163
SEIKO-SEIKI	SS10LV6	SP20	100	MT3013	MT3019	A10-6164
SEIKO-SEIKI	SS121DV2	SP20	100	MT3013	MT3019	A10-6164
SEIKO-SEIKI	SS170PSS	SP20	100	MT3013	MT3019	A10-6164
SEIKO-SEIKI	SS96D		100	MT3013	MT3019	A10-6164
TAMA	TM08HD	ZXL100PG	46	MT3012	MT3018	A10-6163
TECUMSEH	HG500		46	MT3012	MT3018	A10-6163
TECUMSEH	HG850-1000		46	MT3012	MT3018	A10-6163
VISTEON	HS090-110	SP10	46	MT3012	MT3018	A10-6163
VISTEON	HS15	FD46XG	46	MT3012	MT3018	A10-6163
VISTEON	HS17-18	FD46XG	46	MT3012	MT3018	A10-6163
VISTEON	VS18	FD46XG	46	MT3012	MT3018	A10-6163
YORK	206-209-210		46	MT3012	MT3018	A10-6163
YORK	SC206-209		46	MT3012	MT3018	A10-6163
ZEXEL	DCS17E	ZXL100PG	46	MT3012	MT3018	A10-6163

## New Adjustable Shaft Seal Protectors



**Fits Over 90% of  
Compressors**

**Fully Adjustable for  
Multiple Shaft Lengths**

**Tool Steel - Easy to Remove**

**Permanent Setting Possible  
with Nut Adjuster**

**Adjustable Depth Saves Tool  
Life**

**Potential Seal Damage  
Virtually Eliminated**

**Tools to Own for a Lifetime**

### T95-1221 I.D. 0.384 - 0.404

**Mitsubishi**

AX105VSL, AX105VSR, FX80, FX105V Series, FXA105V Series, MSC105CVSG, MSC105CVSG2

**Sanden**

TR105, TR105VS, TR70, TRF105, TRS105

### T95-1224 I.D. 0.444 - 0.464

**Mitsubishi**

MSC105C, MSC105CF, MSC105CVS

**Sanden**

SD5H14, TRSA09, TRSA12, TRSE07

### T95-1225 I.D. 0.464 - 0.484

**Ford**

SCROLL

**Keihin**

150L, 150R, A150L, A150R, AN150L, CN150L, N150L, N150R

**Sanden**

TR90, TRF090, TRS090

**Visteon**

HS090L, HS090R, HS110R

### T95-1226 I.D. 0.484 - 0.504

**Delphi**

CVC-125, CVC-135, CV-165, CVC185

**GM/Harrison/Daewoo (Tripac)**

SP10, SP21, SP8

**Matsushita/Panasonic**

N1300 Series, N1301A Series, N13A0A Series, N1500AB4, N15A0A Series, NL1300A Series, NL1301A Series, NL1302A Series, S1150 Series, SA11A0AA4

**Seiko-Seiki**

SS121D Series, SS140P Series, SS148PB6, SS15BS, SS170P Series, SS808P, SS808PSV, SS811PB Series, SS96D1, SS96D2

### T95-1227 I.D. 0.504 - 0.524

**Calsonic**

CR14

**Delphi**

CVC-135E

**Denso**

10PA15 Series, 10PA17 Series, 10PA20 Series, 10S Series, 5SE09C, 5SE12C, 6CA17C, 6CA17K, 7SB16C, 7SBU16C, SC08C, TV12 Series, TV13SC, TV14 Series

**Ford**

FS10, FX15

**Hadsys**

RC17D, RC17S

**Sanden**

PXV16, SD5 Series, SD6V12, SD7 Series

**Visteon**

HS15, HS17, HS18, VS16

**Zexel**

DCS17E

### T95-1228 I.D. 0.524 - 0.544

**Calsonic/Nihon**

CWV615, CWV617, CWV618, DKV11A, DKV14A, DKV14C, DKV14D, DKV14G, V5-15C, V5-15F, V5-15G, V618A

**Chrysler**

6C17, A590, C171

**Daewoo**

V5

**Denso**

10P08E, 10P13 Series, 10P15 Series, 10P17 Series, 5SL12CJ, 6E 171, 6E171A, 6P series, 6SEU12, 7SE16, 7SEU16, TV10 Series

**Diesel Kiki/Zexel/Seltec**

DCV11A, DCV11J, DCV14A, DCV14J, DCW17, DCW17B, DCW17BE, DCW17C, DCW17D, DCW17S, DKP12A, DKS10G, DKS12BH, DKS13CH, DKS13G Dual, DKS13G Single, DKS13S, DKS15BH, DKS15CH, DKS15G, DKS15S, DKS17CH, DKS17D, DKS17G Dual, DKS17G Single, DKS17S, DKS26, DKSYA, DKV11G, TM08B, TM08HD, TM13HA, TM13HD, TM14A, TM15HD, TM16HD, TM18HD, TM26, TM31HD

**Ford**

FS6, FS6X

**GM/Harrison/Delphi**

A6, DA6, HD6, HR6, HR6HE, HT6, HU6, R4, V5, V5(Destroker), V515C, V515F, V516G, V618A, V68A, V7, V7 (Destroker)

**Hitachi**

MJ110, MJS130

**Mitsubishi**

MSC90, MSC90C

### T95-1229 I.D. 0.544 - 0.564

**Denso**

6SEU16, SCS06C, SCSA06, SCSC06

**Sanden**

SD7V16

**Seiko-Seiki**

SS10LV6, SS10V1, SS10V6

### T95-1230 I.D. 0.564 - 0.584

**Diesel Kiki/Zexel/Seltec**

DKS16H (R12), DKS16H (R134a)

**Hitachi**

A5000, MJ123, MJ167, MJS170, SWP123, SWP167

**Sanden**

PXE13, PXE16, SD7C16

### T95-1232

**Kit includes 1 each of the  
above 8 Protectors**

## Santech Pad and Plate Chart

### A Revolutionary Design In Pad and Plate Products for the A/C Compressor Rebuilder

C95-3002



C95-3003



C95-3004



C95-3005



C95-3006



C95-4001



C95-4002



Patent Pending

Compressor	Discharge Plug	Discharge Plate	Discharge Bolt	Suction Plug	Suction Plate	Suction Bolt
CALSONIC CR14	C95-3002	C95-4001	F11-2100	C95-3004	C95-4001	F11-2100
CALSONIC CSV613	C95-3003	C95-4001	F11-2100	C95-3006	C95-4001	F11-2100
CALSONIC CWV615	C95-3003	C95-4001	F11-2100	C95-3006	C95-4001	F11-2100
CALSONIC CWV617	C95-3003	C95-4001	F11-2100	C95-3006	C95-4001	F11-2100
CALSONIC CWV618	C95-3003	C95-4001	F11-2100	C95-3006	C95-4001	F11-2100
CALSONIC DKV14D	C95-3003	C95-4001	F11-2100	C95-3006	C95-4001	F11-2100
CALSONIC V5-15C	C95-3003	C95-4001	F11-2100	C95-3006	C95-4001	F11-2100
CALSONIC V5-15F	C95-3003	C95-4001	F11-2100	C95-3006	C95-4001	F11-2100
CALSONIC V5-15G	C95-3003	C95-4001	F11-2100	C95-3006	C95-4001	F11-2100
CHRYSLER 6C17	C95-3004	C95-4001	F11-2100	C95-3004	C95-4001	F11-2100
CHRYSLER A590	C95-3004	C95-4001	F11-2100	C95-3004	C95-4001	F11-2100
CHRYSLER C171	C95-3004	C95-4001	F11-2100	C95-3004	C95-4001	F11-2100
DELPHI SP10	C95-3004	C95-4001	F11-2100	C95-3006	C95-4001	F11-2100
DELPHI SP15	C95-3002	C95-4001	F11-2100	C95-3004	C95-4001	F11-2100
DENSO 10P13A	C95-3004	C95-4001	F11-2100	C95-3003	C95-4001	F11-2100
DENSO 10P13B	C95-3004	C95-4001	F11-2100	C95-3003	C95-4001	F11-2100
DENSO 10P13C	C95-3004	C95-4001	F11-2100	C95-3003	C95-4001	F11-2100
DENSO 10P13E	C95-3004	C95-4001	F11-2100	C95-3003	C95-4001	F11-2100
DENSO 10P13F	C95-3004	C95-4001	F11-2100	C95-3003	C95-4001	F11-2100
DENSO 10P15C	C95-3004	C95-4001	F11-2100	C95-3003	C95-4001	F11-2100
DENSO 10P15E	C95-3004	C95-4001	F11-2100	C95-3003	C95-4001	F11-2100
DENSO 10P15F	C95-3004	C95-4001	F11-2100	C95-3003	C95-4001	F11-2100
DENSO 10P17	C95-3002	C95-4001	F11-2100	C95-3004	C95-4001	F11-2100
DENSO 10P17C	C95-3002	C95-4001	F11-2100	C95-3004	C95-4001	F11-2100
DENSO 10P17VC	C95-3002	C95-4001	F11-2100	C95-3004	C95-4001	F11-2100
DENSO 10S11C	C95-3003	C95-4002	F45-2101	C95-3005	C95-4002	F45-2101
DENSO 10S11P	C95-3003	C95-4002	F45-2101	C95-3005	C95-4002	F45-2101
DENSO 10S13C	C95-3003	C95-4002	F45-2101	C95-3005	C95-4002	F45-2101
DENSO 10S13P	C95-3003	C95-4002	F45-2101	C95-3005	C95-4002	F45-2101
DENSO 10S15C	C95-3003	C95-4002	F45-2101	C95-3005	C95-4002	F45-2101
DENSO 10S15L	C95-3003	C95-4002	F45-2101	C95-3005	C95-4002	F45-2101
DENSO 10S17C	C95-3003	C95-4002	F45-2101	C95-3005	C95-4002	F45-2101
DENSO 10S20C	C95-3003	C95-4002	F45-2101	C95-3005	C95-4002	F45-2101
DENSO 10S20F	C95-3003	C95-4002	F45-2101	C95-3005	C95-4002	F45-2101
DENSO 10S20H	C95-3003	C95-4002	F45-2101	C95-3005	C95-4002	F45-2101
DENSO 10SR15C	C95-3003	C95-4001		C95-3005	C95-4001	
DENSO 10SR17C	C95-3003	C95-4001		C95-3005	C95-4001	

## Santech Pad and Plate Chart

Compressor	Discharge Plug	Discharge Plate	Discharge Bolt	Suction Plug	Suction Plate	Suction Bolt
DENSO 5SE09C	C95-3003	C95-4002	F20-2110	C95-3005	C95-4002	F20-2110
DENSO 5SE12C	C95-3003	C95-4002		C95-3005	C95-4002	
DENSO 5SL12CJ	C95-3003	C95-4002	F20-2110	C95-3005	C95-4002	F20-2110
DENSO 6E171	C95-3003	C95-4001	F11-2100	C95-3002	C95-4001	F11-2100
DENSO 6E171A	C95-3003	C95-4001	F11-2100	C95-3002	C95-4001	F11-2100
DENSO 6P127A	C95-3003	C95-4001	F11-2100	C95-3004	C95-4001	F11-2100
DENSO 6P127B	C95-3003	C95-4001	F11-2100	C95-3004	C95-4001	F11-2100
DENSO 6P127D	C95-3003	C95-4001	F11-2100	C95-3004	C95-4001	F11-2100
DENSO 6P134	C95-3003	C95-4001	F11-2100	C95-3004	C95-4001	F11-2100
DENSO 6P148	C95-3003	C95-4001	F11-2100	C95-3004	C95-4001	F11-2100
DENSO 6P148A	C95-3003	C95-4001	F11-2100	C95-3004	C95-4001	F11-2100
DENSO 6P148C	C95-3003	C95-4001	F11-2100	C95-3004	C95-4001	F11-2100
DENSO 6SEU12	C95-3003	C95-4001	F11-2100	C95-3004	C95-4001	F11-2100
DENSO 6SEU12C	C95-3003	C95-4002	F45-2101	C95-3005	C95-4002	F45-2101
DENSO 6SEU14C	C95-3003	C95-4002	F45-2101	C95-3005	C95-4002	F45-2101
DENSO 6SEU16	C95-3003	C95-4002	F45-2101	C95-3005	C95-4002	F45-2101
DENSO 7SE16	C95-3002	C95-4001	F11-2100			
DENSO 7SEU16	C95-3002	C95-4001	F11-2100			
DENSO 7SEU17C	C95-3002	C95-4001	F11-2100			
DENSO SC08 (ITALY)	C95-3003	C95-4002	F45-2101	C95-3005	C95-4002	F45-2101
DENSO SC08C (SPAIN)	C95-3004	C95-4002	F45-2101	C95-3006	C95-4002	F45-2101
DENSO SC08C (USA)	C95-3004	C95-4002	F45-2101	C95-3005	C95-4002	F45-2101
DENSO SCS06C	C95-3003	C95-4002	F45-2101	C95-3005	C95-4002	F45-2101
DENSO SCSA06	C95-3003	C95-4002	F20-2110	C95-3005	C95-4002	F20-2110
DENSO SCSC06	C95-3003	C95-4002	F20-2110	C95-3005	C95-4002	F20-2110
DENSO TV10CA	C95-3004	C95-4001	F11-2100	C95-3006	C95-4001	F11-2100
DENSO TV10CB	C95-3004	C95-4001	F11-2100	C95-3006	C95-4001	F11-2100
DENSO TV12C(R12)	C95-3004	C95-4001	F11-2100	C95-3006	C95-4001	F11-2100
DENSO TV12C(R134)	C95-3004	C95-4002	F45-2101	C95-3006	C95-4002	F45-2101
DENSO TV12EC(R12)	C95-3004	C95-4001	F11-2100	C95-3006	C95-4001	F11-2100
DENSO TV12SC(R134)	C95-3004	C95-4002	F45-2101	C95-3004	C95-4002	F45-2101
DENSO TV14C	C95-3004	C95-4001	F11-2100	C95-3006	C95-4001	F11-2100
DENSO TV14EC	C95-3004	C95-4001	F11-2100	C95-3006	C95-4001	F11-2100
DENSO TV14SC	C95-3004	C95-4002	F45-2101	C95-3004	C95-4002	F45-2101
DIESEL KIKI DCV11A	C95-3003	C95-4001	F11-2100	C95-3004	C95-4001	F11-2100
DIESEL KIKI DCV11D	C95-3003	C95-4001		C95-3004	C95-4001	
DIESEL KIKI DCV14A	C95-3003	C95-4001	F11-2100	C95-3004	C95-4001	F11-2100
DIESEL KIKI DCV14J	C95-3003	C95-4001	F11-2100	C95-3006	C95-4001	F11-2100
DIESEL KIKI DKS16H(R12)	C95-3002	C95-4001	F11-2100	C95-3004	C95-4001	F11-2100
DIESEL KIKI DKS16H(R134A)	C95-3003	C95-4001	F11-2100	C95-3004	C95-4001	F11-2100
DIESEL KIKI DKV11A	C95-3002	C95-4001	F11-2100	C95-3004	C95-4001	F11-2100
DIESEL KIKI DKV11G	C95-3003	C95-4001	F11-2100	C95-3006	C95-4001	F11-2100
DIESEL KIKI DKV14G	C95-3003	C95-4001	F11-2100	C95-3006	C95-4001	F11-2100
DIESEL KIKI DKV14J	C95-3002	C95-4001	F11-2100	C95-3005	C95-4001	F11-2100
FORD FS18	C95-3003	C95-4001		C95-3004	C95-4001	
HADSYS RC17D	C95-3002	C95-4001		C95-3004	C95-4001	

## Santech Pad and Plate Chart

Compressor	Discharge Plug	Discharge Plate	Discharge Bolt	Suction Plug	Suction Plate	Suction Bolt
HADSYS RC17S	C95-3002	C95-4001		C95-3004	C95-4001	
HITACHI A5000	C95-3004	C95-4001	F11-2100	C95-3006	C95-4001	F11-2100
HITACHI MJS170	C95-3004	C95-4001	F11-2100	C95-3006	C95-4001	F11-2100
HITACHI SWP167	C95-3005	C95-4001	F11-2100	C95-3006	C95-4001	F11-2100
MATS/PAN H12A1AH4DX	C95-3002	C95-4002	F20-2110	C95-3004	C95-4002	F20-2110
MATS/PAN N1301AB4	C95-3004	C95-4001	F11-2100	C95-3004	C95-4001	F11-2100
MATS/PAN N1301AD4	C95-3004	C95-4001	F11-2100	C95-3004	C95-4001	F11-2100
MATS/PAN N1301AE4	C95-3004	C95-4001	F11-2100	C95-3004	C95-4001	F11-2100
MATS/PAN N1301AE4	C95-3004	C95-4001	F11-2100	C95-3006	C95-4001	F11-2100
MATS/PAN NL1300AA4	C95-3004	C95-4001	F11-2100	C95-3004	C95-4001	F11-2100
MATS/PAN NL1300AE4	C95-3004	C95-4001	F11-2100	C95-3004	C95-4001	F11-2100
MATS/PAN NL1300AE4	C95-3006	C95-4001	F11-2100	C95-3004	C95-4001	F11-2100
MATS/PAN S1150F3	C95-3005	C95-4002	F45-2101	C95-3006	C95-4002	F45-2101
MATS/PAN SA1150AE4	C95-3004	C95-4001	F11-2100	C95-3006	C95-4001	F11-2100
mitsubishi FX105V	C95-3004	C95-4001	F11-2100	C95-3006	C95-4001	F11-2100
mitsubishi FX80	C95-3004	C95-4001	F11-2100	C95-3006	C95-4001	F11-2100
mitsubishi MSC130CVSG	C95-3004	C95-4001		C95-3006	C95-4001	
mitsubishi MSC130CVSG2	C95-3004	C95-4001		C95-3006	C95-4001	
mitsubishi MSC90	C95-3004	C95-4001	F11-2100	C95-3006	C95-4001	F11-2100
mitsubishi MSC90C	C95-3004	C95-4001	F11-2100	C95-3006	C95-4001	F11-2100
NIHON DKV14C	C95-3003	C95-4002	F45-2101	C95-3004	C95-4002	F45-2101
NIHON NVR140S	C95-3003	C95-4001	F11-2100	C95-3003	C95-4001	F11-2100
SANDEN PXE13	C95-3003	C95-4001				
SANDEN PXE16	C95-3003	C95-4001				
SANDEN PXV16	C95-3003	C95-4001	F11-2100			
SANDEN SD5H09	C95-3002	C95-4001	F11-2100	C95-3003	C95-4001	F11-2100
SANDEN SD709CA	C95-3004	C95-4001	F11-2100	C95-3004	C95-4001	F11-2100
SANDEN SD709CP	C95-3003	C95-4001	F11-2100	C95-3003	C95-4001	F11-2100
SANDEN SD7B10	C95-3003	C95-4002	F45-2101	C95-3005	C95-4002	F45-2101
SANDEN SD7C16	C95-3003	C95-4002		C95-3006	C95-4002	
SANDEN TR090	C95-3002	C95-4001	F11-2100	C95-3003	C95-4001	F11-2100
SANDEN TR70	C95-3004	C95-4001	F25-2101	C95-3006	C95-4001	F25-2101
SANDEN TRF090	C95-3004	C95-4001	F11-2100	C95-3006	C95-4001	F11-2100
SANDEN TRS090	C95-3004	C95-4001	F11-2100	C95-3006	C95-4001	F11-2100
SANDEN TRSA09	C95-3003	C95-4001	F20-2110	C95-3005	C95-4001	F20-2110
SANDEN TRSE07	C95-3003	C95-4001	F20-2110	C95-3005	C95-4001	F20-2110
SEIKO-SEIKI SS10LV6	C95-3004	C95-4002	F45-2101	C95-3005	C95-4002	F45-2101
SEIKO-SEIKI SS10V1	C95-3004	C95-4002	F45-2101	C95-3005	C95-4002	F45-2101
SEIKO-SEIKI SS10V6	C95-3004	C95-4002	F45-2101	C95-3005	C95-4002	F45-2101
SEIKO-SEIKI SS121DN1	C95-3002	C95-4001	F11-2100	C95-3004	C95-4001	F11-2100
SEIKO-SEIKI SS121DN2	C95-3002	C95-4001	F11-2100	C95-3004	C95-4001	F11-2100
SEIKO-SEIKI SS121DV2	C95-3002	C95-4001	F11-2100	C95-3004	C95-4001	F11-2100
SEIKO-SEIKI SS96D1	C95-3002	C95-4001	F11-2100	C95-3004	C95-4001	F11-2100
SEIKO-SEIKI SS96D2	C95-3002	C95-4001	F11-2100	C95-3004	C95-4001	F11-2100
VISTEON HS090L	C95-3003	C95-4002	F20-2110	C95-3004	C95-4002	F20-2110
VISTEON HS090R	C95-3003	C95-4002	F20-2110	C95-3004	C95-4002	F20-2110



## Santech Pad and Plate Chart

Compressor	Discharge Plug	Discharge Plate	Discharge Bolt	Suction Plug	Suction Plate	Suction Bolt
VISTEON HS110R	C95-3003	C95-4002	F20-2110	C95-3004	C95-4002	F20-2110
VISTEON HS15	C95-3002	C95-4001	F11-2100	C95-3004	C95-4001	F11-2100
VISTEON HS17	C95-3002	C95-4001	F11-2100	C95-3004	C95-4001	F11-2100
VISTEON HS18	C95-3002	C95-4001	F11-2100	C95-3004	C95-4001	F11-2100
VISTEON VS16	C95-3003	C95-4001	F12-2105	C95-3003	C95-4001	F12-2105
VISTEON VS18M	C95-3003	C95-4001		C95-3006	C95-4001	
YORK SC206	C95-3006	C95-4001	F40-2101	C95-3006	C95-4001	F40-2101
YORK SC209	C95-3006	C95-4001	F40-2101	C95-3006	C95-4001	F40-2101
ZEXEL DCS17E	C95-3003	C95-4001	F20-2110			
ZEXEL DCS17IC	C95-3003	C95-4004	F20-2110	C95-3006	C95-4004	F20-2110

## O-Rings and Lathe Cuts Dimensional Size Chart

O-Ring		Inches				Millimeters			
HNBR	Nitrile	ID	OD	Wall	Cut	ID	OD	Wall	Cut
	M94-1000	0.101	0.241	0.070		2.57	6.12	1.78	
M25-2101	M25-1001	0.138	0.256	0.059		3.51	6.50	1.50	
M25-2100	M25-1000	0.145	0.285	0.070		3.68	7.24	1.78	
M96-2101		0.173	0.283	0.055		4.39	7.19	1.40	
M96-2158	M96-1058	0.185	0.297	0.056		4.70	7.54	1.42	
M95-2106	M95-1006	0.208	0.348	0.070		5.28	8.84	1.78	
M65-2105	M65-1005	0.236	0.394	0.079		5.99	10.01	2.01	
M96-2151	M96-1051	0.239	0.367	0.064		6.07	9.32	1.63	
M96-2102	M96-1002	0.239	0.379	0.070		6.07	9.63	1.78	
M96-2104		0.256	0.378	0.061		6.50	9.60	1.55	
M96-2106		0.262	0.468	0.103		6.65	11.89	2.62	
M12-2103	M12-1003	0.266	0.406	0.070		6.76	10.31	1.78	
M10-2102	M10-1002	0.276	0.394	0.059		7.01	10.01	1.50	
M96-2110	M96-1010	0.301	0.429	0.064		7.65	10.90	1.63	
M96-2109	M96-1009	0.301	0.441	0.070		7.65	11.20	1.78	
M96-2111		0.315	0.441	0.063		8.00	11.20	1.60	
M96-2112		0.315	0.455	0.070		8.00	11.56	1.78	
M30-2122		0.315	0.473	0.079		8.00	12.01	2.01	
M96-2113		0.331	0.465	0.067		8.41	11.81	1.70	
M96-2114		0.341	0.459	0.059		8.66	11.66	1.50	
M96-2171		0.350	0.506	0.078		8.89	12.85	1.98	
M96-2115	M96-1015	0.351	0.495	0.072		8.92	12.57	1.83	
M20-2163		0.354	0.472	0.059		8.99	11.99	1.50	
M96-2116	M96-1016	0.362	0.568	0.103		9.19	14.43	2.62	
M96-2118	M96-1018	0.364	0.504	0.070		9.25	12.80	1.78	
M96-2117		0.364	0.554	0.095		9.25	14.07	2.41	
M96-2155		0.386	0.574	0.094		9.80	14.58	2.39	
M30-2125		0.394	0.552	0.079		10.01	14.02	2.01	
M30-2121		0.394	0.590	0.098		10.01	14.99	2.49	
M12-2108		0.400	0.546	0.073		10.16	13.87	1.85	
M96-2121	M96-1021	0.414	0.558	0.072		10.52	14.17	1.83	
M96-2156		0.417	0.535	0.059		10.59	13.59	1.50	
M96-2122	M96-1022	0.424	0.630	0.103		10.77	16.00	2.62	
M96-2123	M96-1023	0.426	0.566	0.070		10.82	14.38	1.78	
M96-2126		0.433	0.559	0.063		11.00	14.20	1.60	
M11-2111		0.453	0.633	0.090		11.51	16.08	2.29	
M96-2150		0.457	0.653	0.098		11.61	16.59	2.49	
	M12-1009	0.472	0.630	0.079		11.99	16.00	2.01	
M65-2115	M65-1015	0.472	0.668	0.098		11.99	16.97	2.49	
M13-2102	M13-1002	0.487	0.693	0.103		12.37	17.60	2.62	
M96-2129	M96-1029	0.489	0.629	0.070		12.42	15.98	1.78	
M50-2105	M50-1005	0.492	0.688	0.098		12.50	17.48	2.49	
M96-2174		0.496	0.636	0.070		12.60	16.15	1.78	
M50-2110		0.512	0.630	0.059		13.00	16.00	1.50	
M96-2130		0.512	0.638	0.063		13.00	16.21	1.60	
M20-2131		0.512	0.670	0.079		13.00	17.02	2.01	
M96-2131		0.528	0.668	0.070		13.41	16.97	1.78	
M50-2104	M50-1004	0.531	0.727	0.098		13.49	18.47	2.49	

## O-Rings and Lathe Cuts Dimensional Size Chart

O-Ring		Inches				Millimeters			
HNBR	Nitrile	ID	OD	Wall	Cut	ID	OD	Wall	Cut
M20-2160		0.535	0.723	0.094		13.59	18.36	2.39	
M96-2133	M96-1033	0.546	0.824	0.139		13.87	20.93	3.53	
M96-2134	M96-1034	0.549	0.755	0.103		13.94	19.18	2.62	
M96-2132	M96-1032	0.551	0.691	0.070		14.00	17.55	1.78	
M20-2132	M20-1032	0.551	0.709	0.079		14.00	18.01	2.01	
M20-2125		0.551	0.747	0.098		14.00	18.97	2.49	
M95-2105	M95-1005	0.551	0.787	0.118		14.00	19.99	3.00	
M10-2110	M10-1010	0.563	0.751	0.094		14.30	19.08	2.39	
M65-2101		0.575	0.763	0.094		14.61	19.38	2.39	
M50-2103	M50-1003	0.591	0.709	0.059		15.01	18.01	1.50	
M20-2116	M20-1016	0.591	0.787	0.098		15.01	19.99	2.49	
M20-2119		0.610	0.768	0.079		15.49	19.51	2.01	
M96-2138	M96-1038	0.612	0.818	0.103		15.54	20.78	2.62	
M96-2137	M96-1037	0.614	0.754	0.070		15.60	19.15	1.78	
M12-2112		0.617	0.769	0.076		15.67	19.53	1.93	
M65-2106	M65-1006	0.630	0.788	0.079		16.00	20.02	2.01	
M20-2133		0.630	0.812	0.091		16.00	20.62	2.31	
M96-2164		0.634	0.760	0.063		16.10	19.30	1.60	
M94-2184		0.644	0.818	0.087		16.36	20.78	2.21	
M96-2139		0.648	0.788	0.070		16.46	20.02	1.78	
M20-2164		0.669	0.827	0.079		16.99	21.01	2.01	
M50-2107		0.673	0.783	0.055		17.09	19.89	1.40	
M96-2140	M96-1040	0.674	0.880	0.103		17.12	22.35	2.62	
M96-2141	M96-1041	0.676	0.816	0.070		17.17	20.73	1.78	
M95-2101	M95-1001	0.709	0.867	0.079		18.01	22.02	2.01	
M45-2101	M45-1001	0.709	0.905	0.098		18.01	22.99	2.49	
M96-2153	M96-1053	0.737	0.943	0.103		18.72	23.95	2.62	
M11-2106	M11-1006	0.739	0.879	0.070		18.77	22.33	1.78	
M50-2111		0.748	0.944	0.098		19.00	23.98	2.49	
A12-1110 (Oval)		0.748	0.964	0.108	0.143	19.00	24.49	2.74	3.63
M11-2105	M11-1005	0.755	0.949	0.097		19.18	24.10	2.46	
M20-2162		0.772	0.960	0.094		19.61	24.38	2.39	
G20-3112 (Tabbed)		0.776	0.972	0.098		19.71	24.69	2.49	
	M35-1000	0.787	0.905	0.059		19.99	22.99	1.50	
M96-2145		0.787	0.945	0.079		19.99	24.00	2.01	
	M50-1002	0.787	0.983	0.098		19.99	24.97	2.49	
M96-2144	M96-1044	0.796	1.074	0.139		20.22	27.28	3.53	
M30-2100	M30-1000	0.799	1.005	0.103		20.29	25.53	2.62	
M96-2146	M96-1046	0.801	0.941	0.070		20.35	23.90	1.78	
M11-2101	M11-1001	0.859	1.137	0.139		21.82	28.88	3.53	
M96-2148	M96-1048	0.862	1.068	0.103		21.89	27.13	2.62	
M95-2107	M95-1007	0.864	1.004	0.070		21.95	25.50	1.78	
M96-2147		0.866	1.056	0.095		22.00	26.82	2.41	
M20-2115	M20-1015	0.906	1.064	0.079		23.01	27.03	2.01	
A13-1110 (Oval)		0.906	1.110	0.102	0.138	23.01	28.19	2.59	3.51
M11-2102	M11-1002	0.921	1.199	0.139		23.39	30.45	3.53	
M96-2152	M96-1052	0.924	1.130	0.103		23.47	28.70	2.62	
M96-2149		0.945	1.135	0.095		24.00	28.83	2.41	

## O-Rings and Lathe Cuts Dimensional Size Chart

O-Ring		Inches				Millimeters			
HNBR	Nitrile	ID	OD	Wall	Cut	ID	OD	Wall	Cut
	M30-1018	0.984	1.180	0.098		24.99	29.97	2.49	
M20-2118	M20-1018	0.984	1.220	0.118		24.99	30.99	3.00	
M30-2101	M30-1001	0.987	1.193	0.103		25.07	30.30	2.62	
M13-2111	M13-1011	0.989	1.129	0.070		25.12	28.68	1.78	
M13-2103	M13-1003	1.049	1.255	0.103		26.64	31.88	2.62	
	M35-1005	1.063	1.221	0.079		27.00	31.01	2.01	
M13-2113	M13-1013	1.114	1.254	0.070		28.30	31.85	1.78	
M25-2117	M25-1017	1.161	1.319	0.079		29.49	33.50	2.01	
	M45-1005	1.174	1.380	0.103		29.82	35.05	2.62	
M13-2101	M13-1001	1.220	1.464	0.122		30.99	37.19	3.10	
M13-2104	M13-1004	1.237	1.443	0.103		31.42	36.65	2.62	
M13-2109	M13-1009	1.239	1.379	0.070		31.47	35.03	1.78	
M20-2171	M20-1071	1.296	1.574	0.139		32.92	39.98	3.53	
M94-2102	M94-1002	1.301	1.441	0.070		33.05	36.60	1.78	
M45-2102	M45-1002	1.339	1.497	0.079		34.01	38.02	2.01	
	M11-1003	1.359	1.637	0.139		34.52	41.58	3.53	
M95-2108	M95-1008	1.364	1.504	0.070		34.65	38.20	1.78	
	M20-1023	1.378	1.614	0.118		35.00	41.00	3.00	
	M11-1000	1.487	1.693	0.103		37.77	43.00	2.62	
	M60-1013	1.575	1.693	0.059		40.01	43.00	1.50	
	M45-1003	1.575	1.733	0.079		40.01	44.02	2.01	
	M60-1012	1.890	2.048	0.079		48.01	52.02	2.01	
	M94-1008	2.239	2.379	0.070		56.87	60.43	1.78	
	M65-1025	2.362	2.520	0.079		59.99	64.01	2.01	
	M65-1031	2.520	2.678	0.079		64.01	68.02	2.01	
	M11-1004	2.609	2.887	0.139		66.27	73.33	3.53	
	M13-1005	2.612	2.818	0.103		66.34	71.58	2.62	
	M25-1018	2.800	3.006	0.103		71.12	76.35	2.62	
	M25-1021	2.864	3.004	0.070		72.75	76.30	1.78	
M20-2126		2.874	3.056	0.091		73.00	77.62	2.31	
	M13-1006	2.987	3.193	0.103		75.87	81.10	2.62	
	M45-1004	2.989	3.129	0.070		75.92	79.48	1.78	
M50-2112	M50-1012	2.992	3.150	0.079		76.00	80.01	2.01	
	M35-1004	3.150	3.308	0.079		80.01	84.02	2.01	
	M25-1010	3.150	3.386	0.118		80.01	86.00	3.00	
	M40-1000	3.239	3.379	0.070		82.27	85.83	1.78	
M20-2130		3.268	3.464	0.098		83.01	87.99	2.49	
M50-2101	M50-1001	3.307	3.465	0.079		84.00	88.01	2.01	
	M35-1003	3.307	3.543	0.118		84.00	89.99	3.00	
M55-2103	M55-1003	3.489	3.629	0.070		88.62	92.18	1.78	
M25-2115		3.504	3.740	0.118		89.00	95.00	3.00	
	M35-1001	3.622	3.780	0.079		92.00	96.01	2.01	
	M45-1006	3.737	3.943	0.103		94.92	100.15	2.62	
	M35-1002	3.858	4.094	0.118		97.99	103.99	3.00	
	M20-1010	3.937	4.133	0.098		100.00	104.98	2.49	
M12-2114	M12-1014	3.987	4.193	0.103		101.27	106.50	2.62	
M65-2133	M65-1033	4.016	4.174	0.079		102.01	106.02	2.01	
M55-2101		4.016	4.252	0.118		102.01	108.00	3.00	

## O-Rings and Lathe Cuts Dimensional Size Chart

























































O-Ring		Inches				Millimeters			
HNBR	Nitrile	ID	OD	Wall	Cut	ID	OD	Wall	Cut
	M25-1020	4.109	4.387	0.139		104.37	111.43	3.53	
M55-2102		4.134	4.292	0.079		105.00	109.02	2.01	
M20-2135	M20-1035	4.134	4.330	0.098		105.00	109.98	2.49	
M13-2107	M13-1007	4.237	4.443	0.103		107.62	112.85	2.62	
	M94-1015	4.239	4.379	0.070		107.67	111.23	1.78	
M20-2140	M20-1040	4.252	4.488	0.118		108.00	114.00	3.00	
M65-2135	M65-1035	4.291	4.449	0.079		108.99	113.00	2.01	
	M20-1045	4.331	4.489	0.079		110.01	114.02	2.01	
M13-2108	M13-1008	4.487	4.693	0.103		113.97	119.20	2.62	
M30-2126		4.488	4.684	0.098		114.00	118.97	2.49	
M20-2159	M20-1059	4.488	4.724	0.118		114.00	119.99	3.00	
M20-2158	M20-1058	4.528	4.686	0.079		115.01	119.02	2.01	
M30-2120		4.567	4.763	0.098		116.00	120.98	2.49	
	M20-1065	4.646	4.882	0.118		118.01	124.00	3.00	
	M20-1070	4.724	4.882	0.079		119.99	124.00	2.01	
M11-2110		4.882	5.040	0.079		124.00	128.02	2.01	
M60-2100	M60-1000	5.239	5.379	0.070		133.07	136.63	1.78	
	M60-1065	5.512	5.670	0.079		140.00	144.02	2.01	
M13-2114	M13-1014	5.984	6.262	0.139		151.99	159.05	3.53	

Lathe Cut		Inches				Millimeters			
HNBR	Nitrile	ID	OD	Wall	Cut	ID	OD	Wall	Cut
	L50-1000	0.394	1.010	0.308	0.303	10.01	25.65	7.82	7.70
	L40-1002	0.563	0.751	0.094	0.063	14.30	19.08	2.39	1.60
	L40-4101 (Teflon)	0.630	0.756	0.063	0.064	16.00	19.20	1.60	1.63
	L40-1001	0.765	0.925	0.080	0.070	19.43	23.50	2.03	1.78
	L11-1003	1.375	1.625	0.125	0.125	34.93	41.28	3.18	3.18
	L40-1012	1.975	2.115	0.070	0.070	50.17	53.72	1.78	1.78
	L13-1001	2.815	3.011	0.098	0.104	71.50	76.48	2.49	2.64
	L13-1002	3.552	3.812	0.130	0.130	90.22	96.82	3.30	3.30
L25-2101	L25-1001	4.345	4.501	0.078	0.063	110.36	114.33	1.98	1.60
	L11-1010	4.487	4.677	0.095	0.103	113.97	118.80	2.41	2.62
	L11-1011	4.688	4.888	0.100	0.100	119.08	124.16	2.54	2.54
L12-2101		4.800	5.020	0.110	0.140	121.92	127.51	2.79	3.56

## O-Rings and Lathe Cuts Visual Size Chart

All O-Rings & Lathe Cuts are compatible with R-12, R-134a, and R1234yf.

All O-Rings Are Actual Size

 M94-1000	 M25-1001 M25-1001	 M96-2158 M96-1058	 M95-2106 M95-1006	 M96-2151 M96-1051	 M96-2104	 M96-2102 M96-1002
 M65-2105 M65-1005	 M10-2102 M10-1002	 M12-2103	 M96-2110 M96-1010	 M96-2109 M96-1009	 M96-2111	 M96-2112
 M96-2114	 M10-2113	 M96-2106	 M20-2163	 M30-2122	 M96-2115 M96-1015	 M96-2118 M96-1018
 M96-2171	 M96-2156	 M30-2125	 M96-2117	 M96-2121 M96-1021	 M96-2126	 M96-2123 M96-1023
 M96-2116 M96-1016	 M96-2155	 M30-2121	 M96-2129 M96-1029	 M96-2122 M96-1022	 M12-1009	 M50-2110
 M11-2111	 M96-2174	 M96-2130	 M96-2150	 M65-2115 M96-1015	 M96-2131	 M20-2131
 M50-2105 M50-1005	 M96-2132 M96-1032	 M13-2102 M13-1002	 M20-2132 M20-1032	 M50-2103 M50-1003	 M20-2160	 M50-2104 M50-1004
 M20-2125	 M10-2110 M10-1000	 M96-2137 M96-1037	 M96-2134 M96-1034	 M96-2164 M96-1064	 M65-2101	 M20-2119

## O-Rings and Lathe Cuts Visual Size Chart

All O-Rings Are Actual Size

All O-Rings & Lathe Cuts are compatible with R-12, R-134a, and R1234yf.



M12-2112

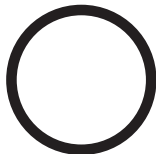

M50-2107



M95-1005



M20-2116  
M20-1016

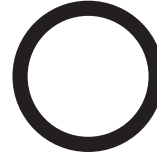

M65-2106  
M65-1006

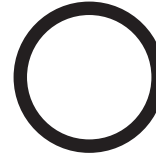

M96-2139



M20-2133



M96-2141  
M96-1041



M96-2138  
M96-1038



M94-2184



M96-2133  
M96-1033



M20-2164



M95-2101  
M95-1001

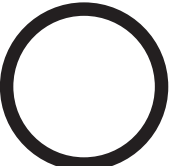

M11-2106  
M11-1006



M96-2140  
M96-1040



M45-2101  
M45-1001

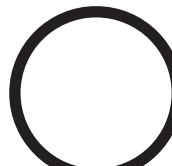

M35-1000

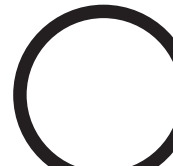

M96-2146  
M96-1046



M96-2153  
M96-1053

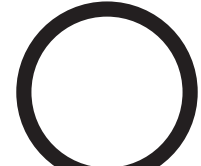

M96-2145



M11-2105  
M11-1005



A12-1110



A12-1110



G20-3112



M50-1002

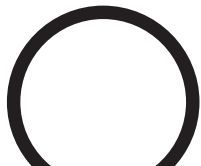

M95-2107  
M95-1007



M30-2100  
M30-1000



M96-2147



M20-2115  
M20-1015



M96-2148  
M96-1048



M96-2144  
M96-1044



A13-1110

## O-Rings and Lathe Cuts Visual Size Chart

All O-Rings & Lathe Cuts are compatible with R-12, R-134a, and R1234yf.

All O-Rings Are Actual Size

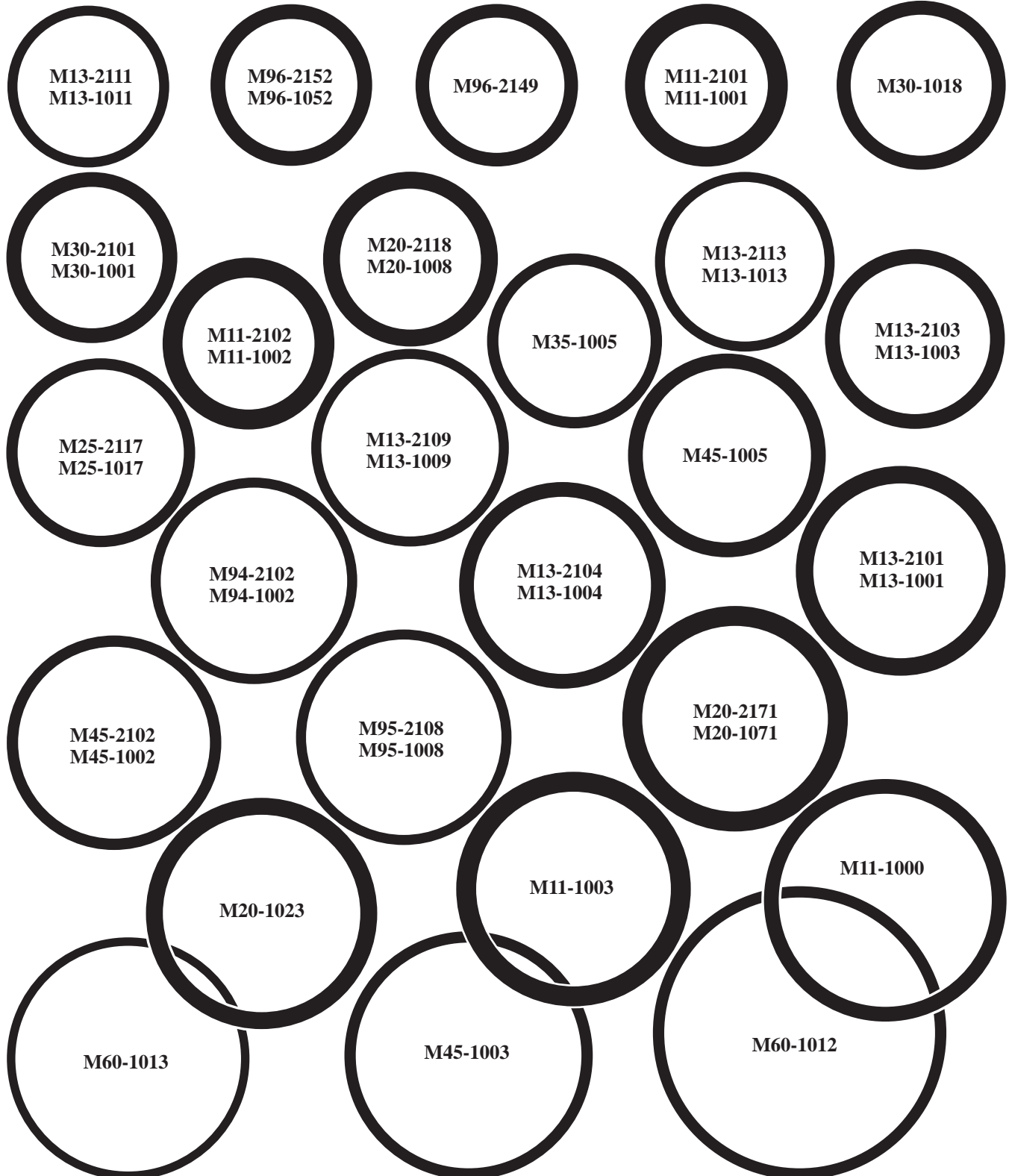



## O-Rings and Lathe Cuts Visual Size Chart

All O-Rings Are Actual Size

All O-Rings & Lathe Cuts are compatible with R-12, R-134a, and R1234yf.

M94-1008

M65-1025

M65-1031

M13-1005

M20-2126

M45-1004

M50-2112

M50-1002

M11-1004

M25-1021

M25-1018

M13-1006

M35-1004

M40-1000

## O-Rings and Lathe Cuts Visual Size Chart

All O-Rings & Lathe Cuts are compatible with R-12, R-134a, and R1234yf.

All O-Rings Are Actual Size

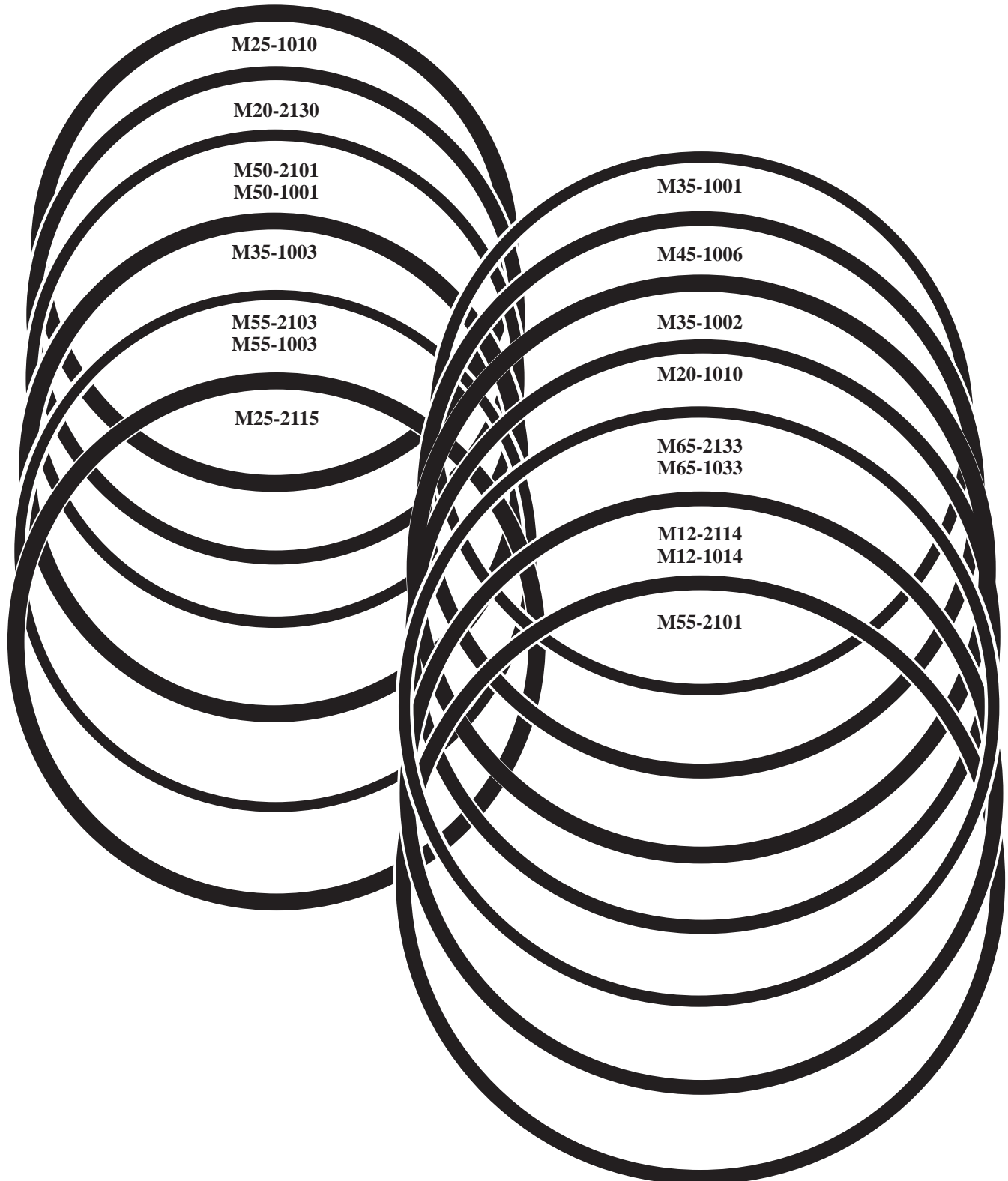

## O-Rings and Lathe Cuts Visual Size Chart

All O-Rings Are Actual Size

All O-Rings & Lathe Cuts are compatible with R-12, R-134a, and R1234yf.

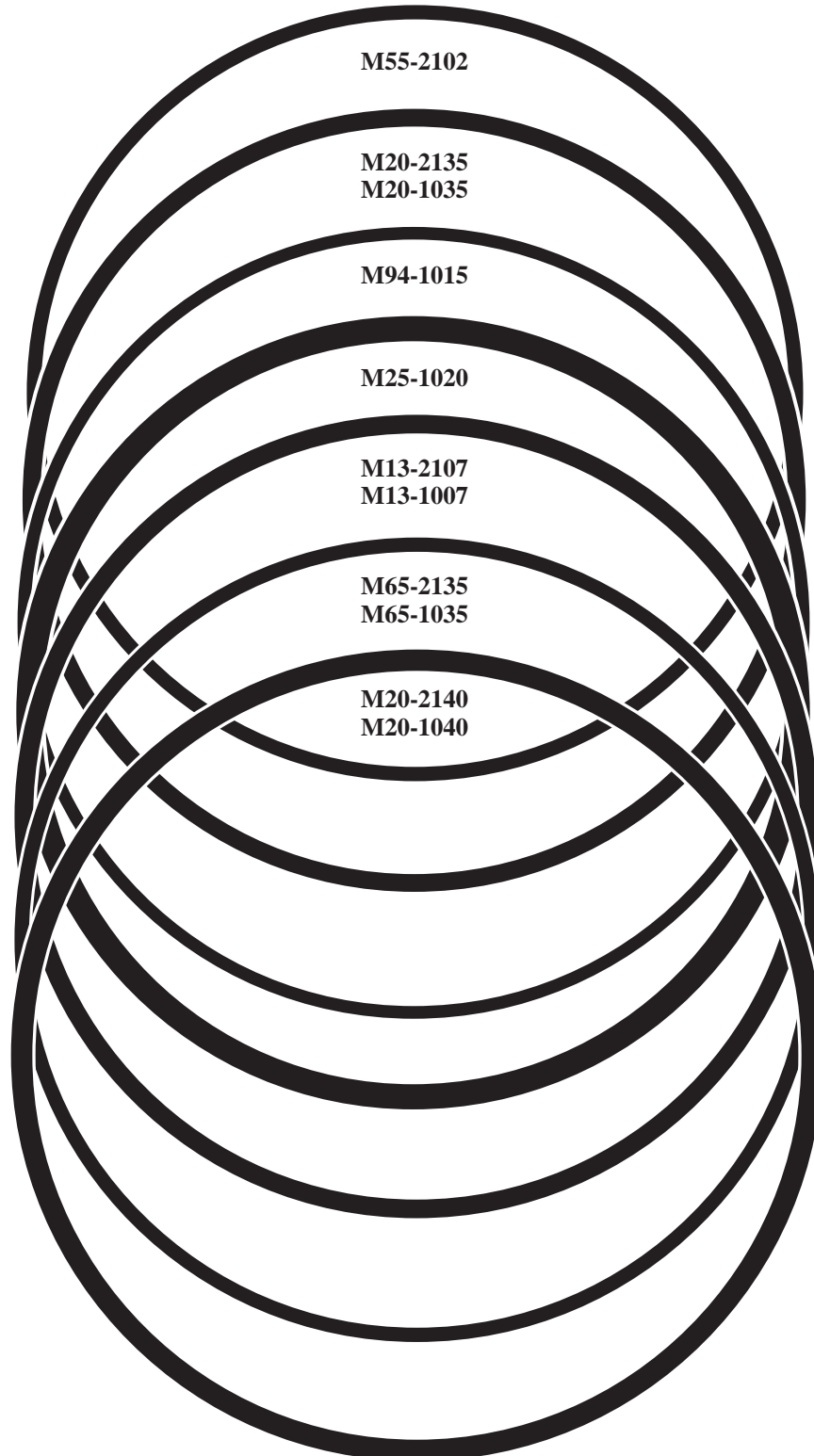

## O-Rings and Lathe Cuts Visual Size Chart

All O-Rings & Lathe Cuts are compatible with R-12, R-134a, and R1234yf.

All O-Rings Are Actual Size

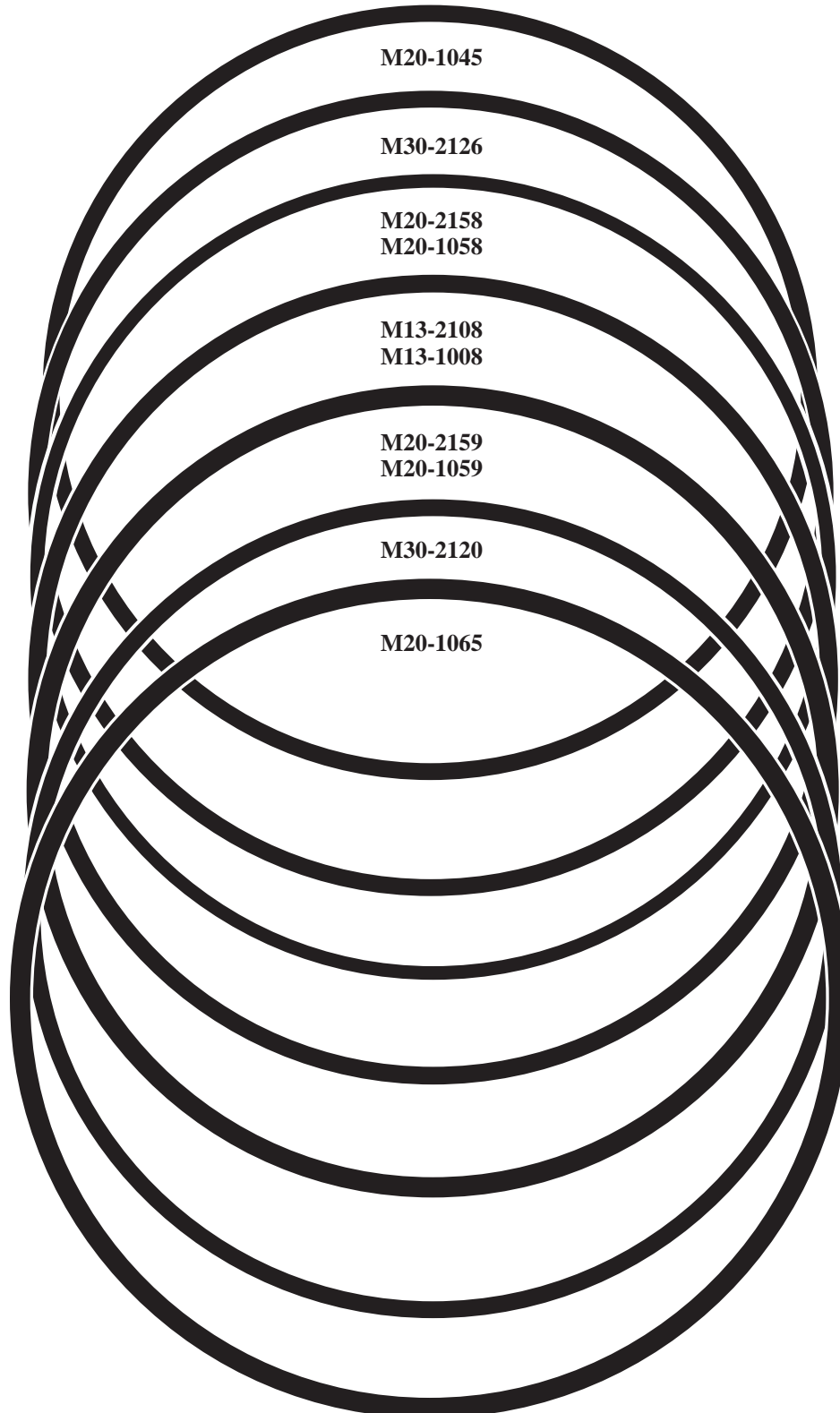

## O-Rings and Lathe Cuts Visual Size Chart

All O-Rings Are Actual Size

All O-Rings & Lathe Cuts are compatible with R-12, R-134a, and R1234yf.

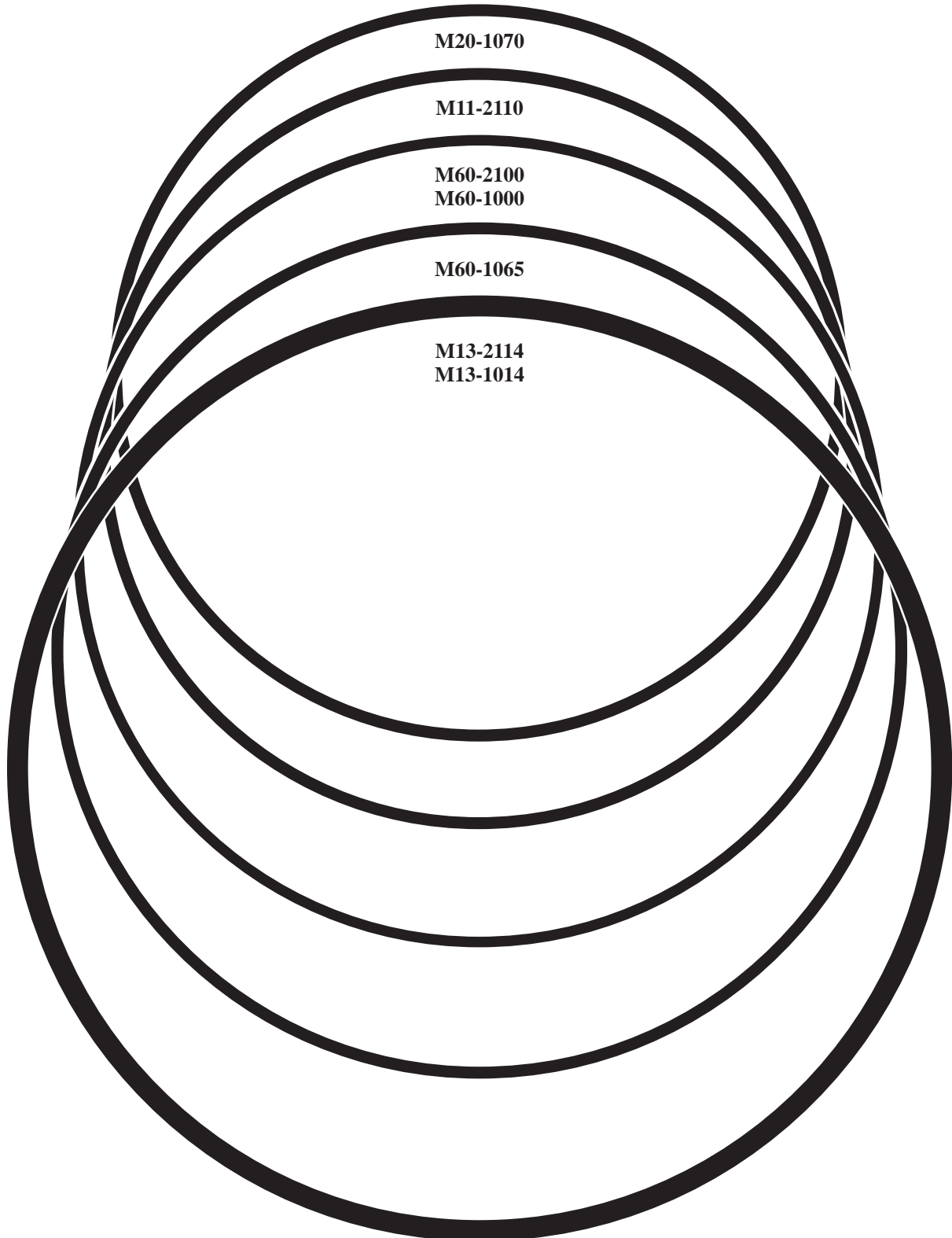

## O-Rings and Lathe Cuts Visual Size Chart

All O-Rings & Lathe Cuts are compatible with R-12, R-134a, and R1234yf.

All O-Rings Are Actual Size



L40-1002



L40-4101

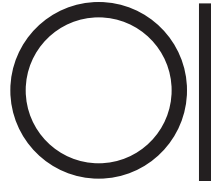

L40-1001



L50-1000

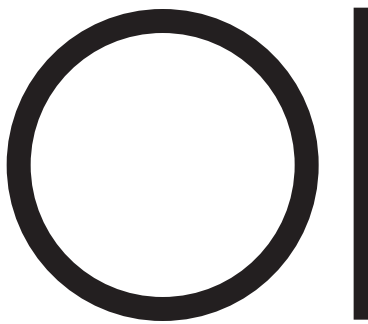

L11-1003

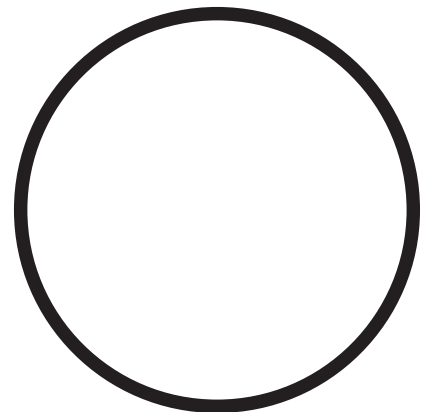

L40-1012

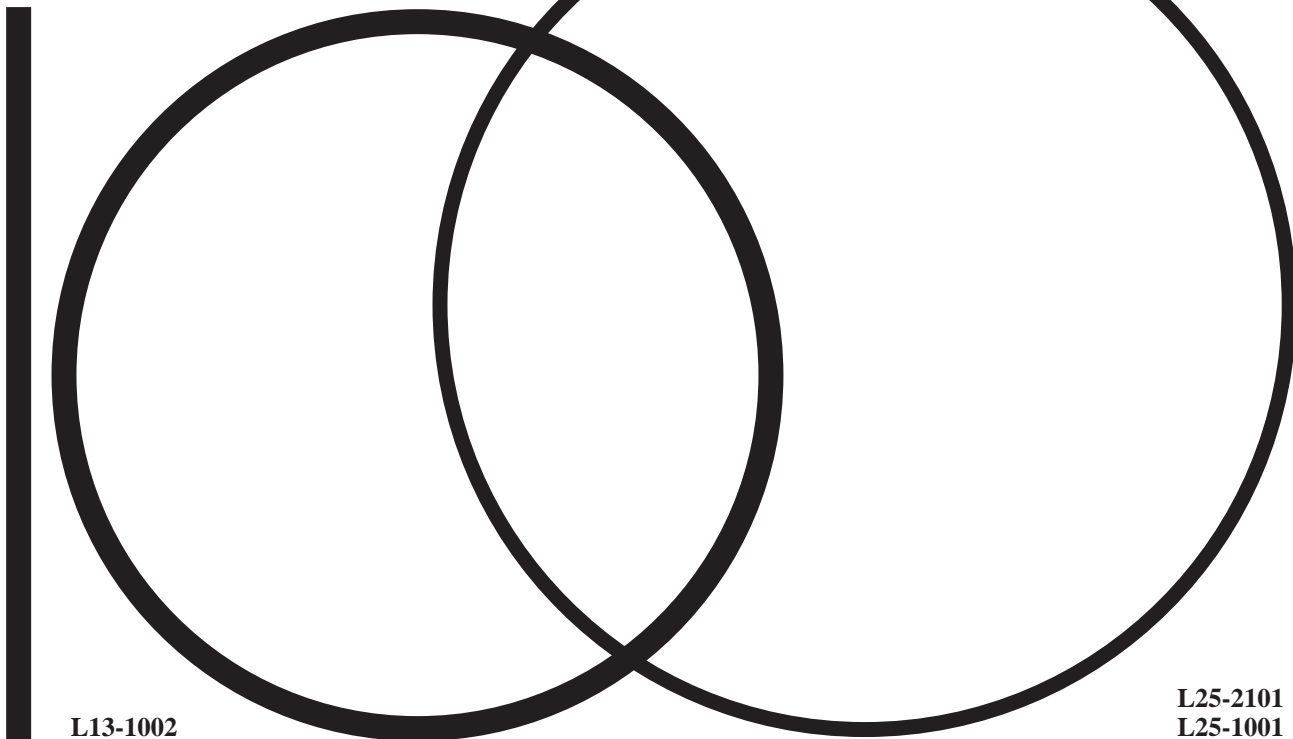

L13-1002

L25-2101  
L25-1001

## O-Rings and Lathe Cuts Visual Size Chart

All O-Rings Are Actual Size

All O-Rings & Lathe Cuts are compatible with R-12, R-134a, and R1234yf.

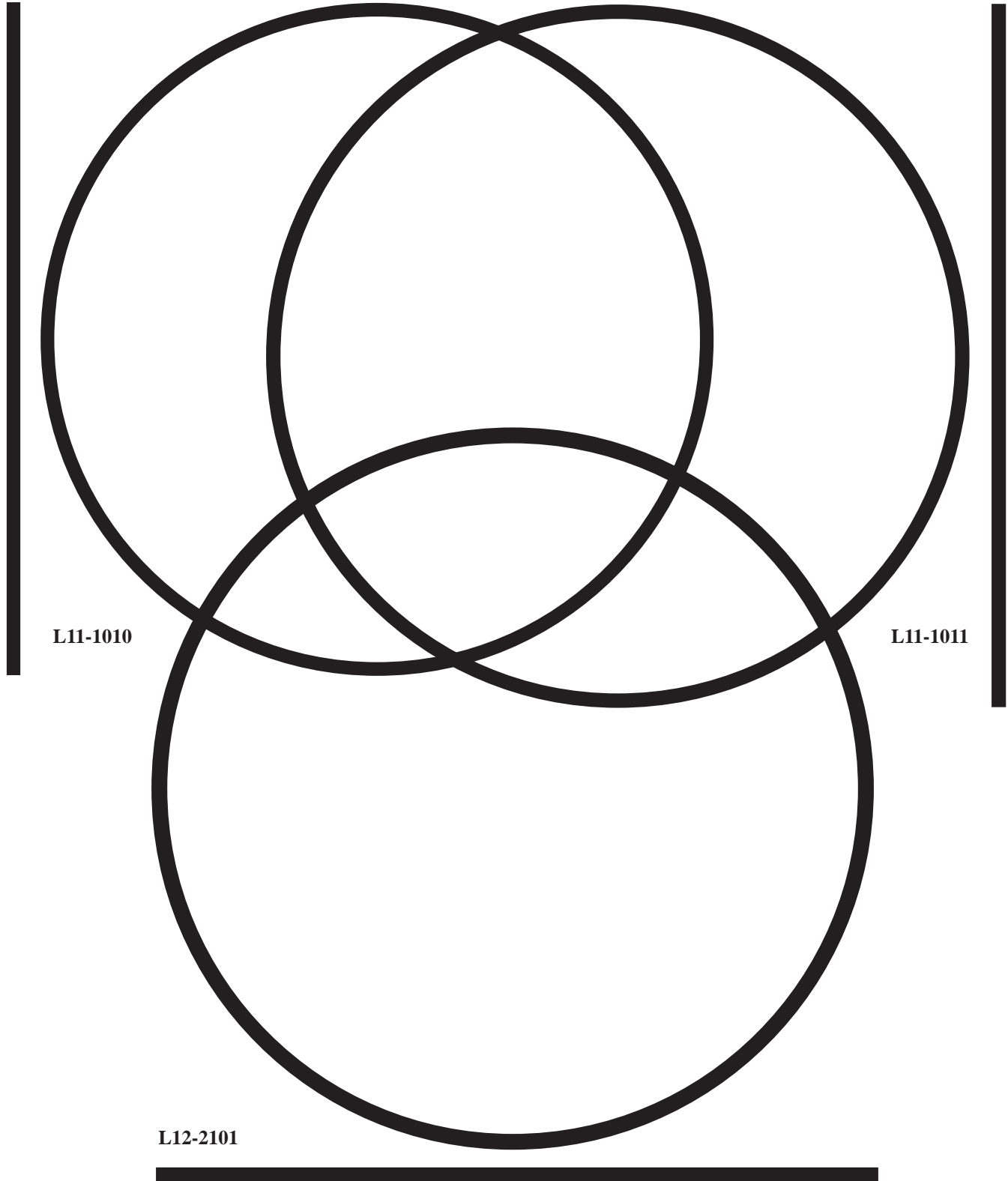

## Sealing Washers and Sealing Components

### Chrysler - Hook & Sealing Washers

All Washers are actual size.

**A11-1000**

Discharge Hook Washer



**A11-1001**

Suction Hook Washer



**A13-1123**

Silver 3/4" Thin



**A13-1124**

Silver 5/8" Thin



### Chrysler - Slim Line Washers

**A11-1008**

7.92mm I.D.

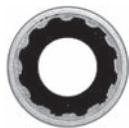

**A11-1009**

9.52mm I.D.



**A11-1015**

11.18mm I.D.



**A11-1019**

13.31mm I.D.



**A11-1010**

14.91mm I.D.



**A11-1016**

14.99mm I.D.



**A11-1021**

15.50mm I.D.



**A11-1020**

17.07mm I.D.



**A11-1017**

17.15mm I.D.



**A11-1011**

17.15mm I.D.



**A11-1012**

17.53mm I.D.

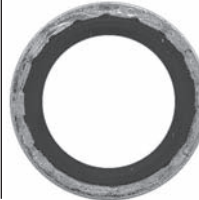

**A11-1013**

17.91mm I.D.

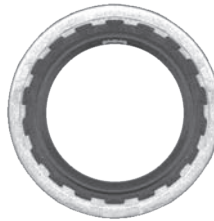

**A11-1018**

19.55mm I.D.



### Chrysler - Sealing Washer & O-Ring Kits (Teardrop)

**K11-2108**

Discharge Kit (Teardrop & O-Ring)

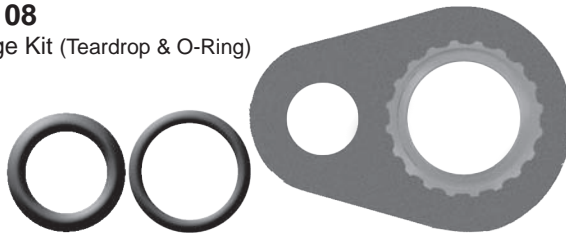

**K11-2109**

Suction Kit (Teardrop & O-Ring)

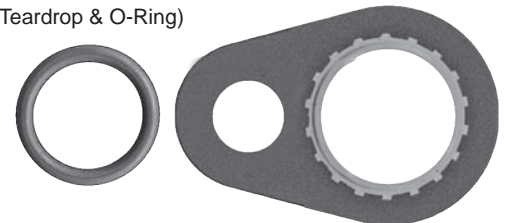

### Ford - Sealing Washer & O-Ring Kits (Teardrop)

**K12-1124**

Discharge Kit (Teardrop & O-Ring)

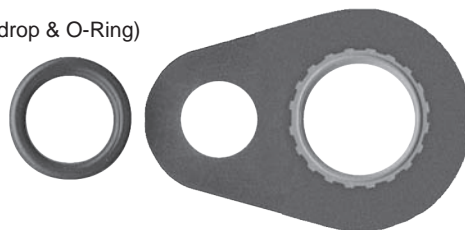

**K12-1125**

Suction Kit (Teardrop & O-Ring)

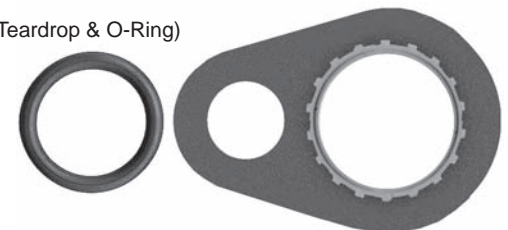



## Sealing Washers and Sealing Components

### General Motors - Sealing Washers

All Washers are actual size.

**A13-1122**  
Black 5/8" Thick



**A13-1123**  
Silver 3/4" Thin



**A13-1124**  
Silver 5/8" Thin



**A13-1126**  
Green



**A13-1127**  
Red



**A13-1128**  
Yellow

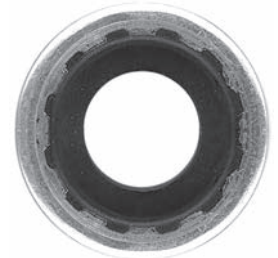

### General Motors - Slim Line Block Fitting Washers

**A13-1139**  
#6-8mm ID



**A13-1140**  
#8-11mm ID



**A13-1137**  
#10-15mm ID



**A13-1141**  
#12-17mm ID



### Freightliner - Slim Line Washers

**A96-1006**  
8.15mm I.D.



**A96-1007**  
11.23mm I.D.



**A96-1008**  
14.22mm I.D.

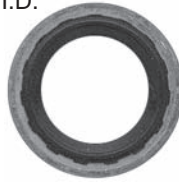

**A96-1010**  
15.37mm I.D.



**A96-1009**  
17.27mm I.D.



### Navistar - Sealing Washer & O-Ring Kits (Teardrop)

**K10-1318**  
Discharge Kit  
(Teardrop &  
O-Ring)

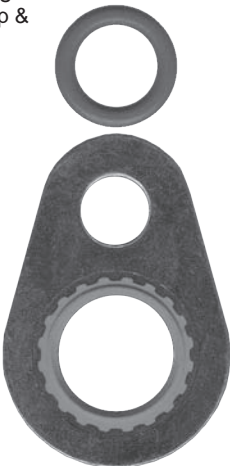

**K10-1319**  
Suction Kit  
(Teardrop &  
O-Ring)



**K10-1322**  
Discharge &  
Suction Kit  
Consists of:  
(1) K10-1318  
(1) K10-1319



## Sealing Washers and Sealing Components

### Sealing Washer Components

All Washers are actual size.

**A13-5109**

GM/Harrison  
Compressor  
Manifolds (Long)



**A13-5110**

GM/Harrison  
Compressor  
Manifolds (Short)



**A13-1138**

Compressor Adapter for GM A/C  
Compressor to Hose Manifold



**F13-2111**

Compressor Bolt  
for GM Adaptor  
Block #MT0182

Head: Hex  
Size: M10-1.5  
Length: 50mm  
Grade: 9.8



### Sealing Washer Kits

**A10-9001**

Laminated Reference Card for  
Compressor Adapter #MT0182

Compressor Rear Head Type	Flow Manifold Type	A	B	C	D	E
		1/2" / 3/8" / 1/4" / 1/8" / 1/16"	1/2" / 3/8" / 1/4" / 1/8" / 1/16"	3/8" / 1/2" / 5/8" / 3/4"	1/2" / 3/8" / 1/4" / 1/8" / 1/16"	1/2" / 3/8" / 1/4" / 1/8" / 1/16"
1	Compressor Port	O-Ring	O-Ring	O-Ring	O-Ring	O-Ring
Compressor Seal	Adapter Block	Black	Black	Black	Black	Black
O-Ring Manifold	O-Ring Manifold	Black	Black	Black	Black	Black
2	Compressor Port	SP Silver	SP Silver	SP Silver	SP Silver	SP Silver
1/2" x 1/8" Flare	Adapter Block	Black	Black	Black	Black	Black
Compressor Seal	O-Ring Manifold	Black	Black	Black	Black	Black
3	Compressor Port	Yellow (GMS)	Yellow (GMS)	Yellow (GMS)	Yellow (GMS)	Yellow (GMS)
Compressor Seal	Adapter Block	Black	Black	Black	Black	Black
O-Ring Manifold	O-Ring Manifold	Black	Black	Black	Black	Black
4	Compressor Port	Yellow (GMS)	Yellow (GMS)	Yellow (GMS)	SP Silver	Yellow (GMS)
1/2" x 1/8" Flare	Adapter Block	Black	Black	Black	Black	Black
Compressor Seal	O-Ring Manifold	Black	Black	Black	Black	Black
5	Compressor Port	SP Silver	SP Silver	SP Silver	SP Silver	SP Silver
1/2" x 1/8" Flare	Adapter Block	Black	Black	Black	Black	Black
Compressor Seal	O-Ring Manifold	Black	Black	Black	Black	Black

**K13-1114**

GM Sealing  
Washer Kit



**K13-2102**

GM Sealing  
Washer Kit  
5/8" & 3/4" Thin



**K13-2101**

GM Sealing  
Washer Kit  
2 - 5/8" Thick



**K13-2124**

GM Compressor Sealing  
Washer Kit (Single Use)



**K13-2125**

GM V5 Compressor Sealing  
Washer Kit (Single Use)



**K13-2126**

GM H6 Compressor Sealing  
Washer Kit (Single Use)



**K13-2127**

GM R4 Compressor Sealing  
Washer Kit (Single Use)



**K13-2135**

GM Sealing Washer  
Silver 5/8" Thin  
Chrysler  
2 - 5/8" Thin



**K13-2136**

GM Sealing Washer  
Black  
5/8" Thick



**K13-2137**

GM Sealing  
Washer Kit







**K13-5104**

GM Sealing Washer Kit



## Sealing Washers and Sealing Components

### A10-9001 Laminated Reference Card for Compressor Adapter

Compressor Rear Head Type	Hose Manifold Type	A		B		C		D		E	
		5/8"	5/8"	5/8"	5/8"	3/4"	5/8"	3/4"	5/8"	5/8"	5/8"
		O-Ring Flat		Flat Pilot Short / Long		Flat Pilot		Offset		Offset	
<b>1</b> O-Ring Flat Compressor Head 	S-Compressor Port	O-Ring	O-Ring	O-Ring	O-Ring	O-Ring	O-Ring	O-Ring	O-Ring	O-Ring	O-Ring
	D-Compressor Port	O-Ring	O-Ring	O-Ring	O-Ring	O-Ring	O-Ring	O-Ring	O-Ring	O-Ring	O-Ring
	Adapter Block	-----	-----	-----	-----	**Required**	**Required**	**Required**	**Required**	**Required**	**Required**
	S-Hose Manifold	-----	-----	-----	-----	3/4" Silver	3/4" Silver	3/4" Silver	3/4" Silver	3/4" Silver	Yellow (Gold)
	D-Hose Manifold	-----	-----	-----	-----	Red	Red	5/8" Silver	5/8" Silver	5/8" Silver	Black
<b>2</b> 5/8" x 5/8" Flat Compressor Head 	S-Compressor Port	5/8" Silver	5/8" Silver	5/8" Silver	5/8" Silver	5/8" Silver	5/8" Silver	5/8" Silver	5/8" Silver	5/8" Silver	Green
	D-Compressor Port	5/8" Silver	5/8" Silver	5/8" Silver	5/8" Silver	5/8" Silver	5/8" Silver	5/8" Silver	5/8" Silver	5/8" Silver	Black
	Adapter Block	-----	-----	-----	-----	**Required**	**Required**	**Required**	**Required**	**Required**	-----
	S-Hose Manifold	-----	-----	-----	-----	3/4" Silver	3/4" Silver	3/4" Silver	3/4" Silver	3/4" Silver	-----
	D-Hose Manifold	-----	-----	-----	-----	Red	Red	5/8" Silver	5/8" Silver	5/8" Silver	-----
<b>3</b> 3/4" x 5/8" Flat Compressor Head 	S-Compressor Port	Yellow (Gold)	Yellow (Gold)	Yellow (Gold)	3/4" Silver	3/4" Silver	3/4" Silver	Yellow (Gold)	Yellow (Gold)	Yellow (Gold)	Yellow (Gold)
	D-Compressor Port	Black	Black	Black	5/8" Silver	5/8" Silver	5/8" Silver	Black	Black	Black	Black
	Adapter Block	-----	-----	-----	-----	-----	-----	**Required**	**Required**	**Required**	**Required**
	S-Hose Manifold	-----	-----	-----	-----	-----	-----	3/4" Silver	3/4" Silver	3/4" Silver	Yellow (Gold)
	D-Hose Manifold	-----	-----	-----	-----	-----	-----	5/8" Silver	5/8" Silver	5/8" Silver	Black
<b>4</b> 3/4" x 5/8" Offset Compressor Head 	S-Compressor Port	Yellow (Gold)	Yellow (Gold)	Yellow (Gold)	Yellow (Gold)	Yellow (Gold)	Yellow (Gold)	3/4" Silver	3/4" Silver	3/4" Silver	Yellow (Gold)
	D-Compressor Port	Green	Green	Green	Green	Green	Green	5/8" Silver	5/8" Silver	5/8" Silver	Green
	Adapter Block	-----	-----	-----	-----	**Required**	**Required**	-----	-----	-----	**Required**
	S-Hose Manifold	-----	-----	-----	-----	3/4" Silver	3/4" Silver	-----	-----	-----	Yellow (Gold)
	D-Hose Manifold	-----	-----	-----	-----	Red	Red	-----	-----	-----	Black
<b>5</b> 5/8" x 5/8" Offset Compressor Head 	S-Compressor Port	5/8" Silver	5/8" Silver	5/8" Silver	5/8" Silver	5/8" Silver	5/8" Silver	5/8" Silver	5/8" Silver	5/8" Silver	5/8" Silver
	D-Compressor Port	Red	Red	Red	Red	Red	Red	Red	Red	Red	Red
	Adapter Block	-----	-----	-----	-----	**Required**	**Required**	**Required**	**Required**	**Required**	-----
	S-Hose Manifold	-----	-----	-----	-----	3/4" Silver	3/4" Silver	3/4" Silver	3/4" Silver	3/4" Silver	-----
	D-Hose Manifold	-----	-----	-----	-----	Red	Red	5/8" Silver	5/8" Silver	5/8" Silver	-----

© 2013 Santech Industries, LLC All Rights Reserved

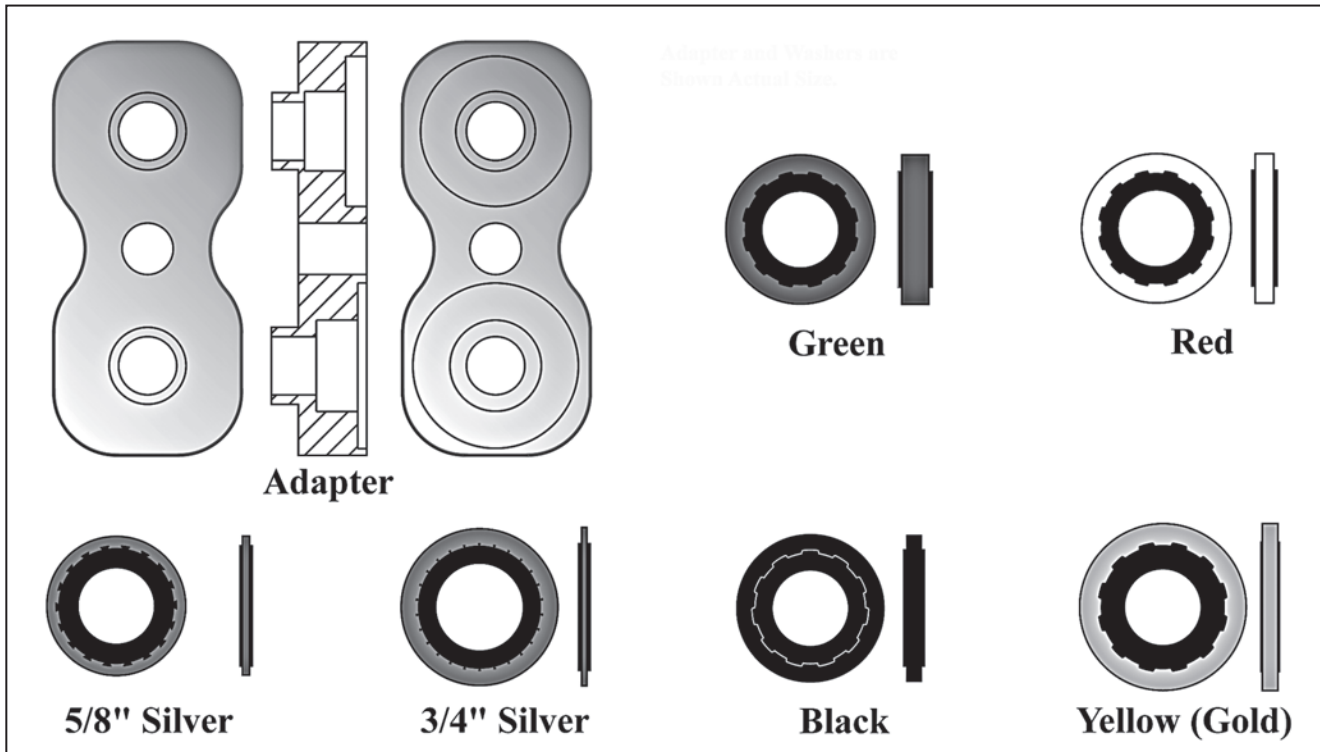

## Santech Clutch Shim Chart

Shim	I.D.	O.D.	Thickness
F11-3105	0.337" / 8.56mm	0.480" / 12.19mm	0.008" / 0.20mm
F11-3115	0.337" / 8.56mm	0.480" / 12.19mm	0.020" / 0.51mm
F12-3110	0.271" / 6.88mm	0.444" / 11.28mm	0.015" / 0.38mm
F12-3111	0.258" / 6.55mm	0.438" / 11.13mm	0.022" / 0.56mm
F12-3112	0.252" / 6.40mm	0.437" / 11.10mm	0.048" / 1.22mm
F25-3101	0.515" / 13.08mm	0.860" / 21.84mm	0.005" / 0.13mm
F25-3104	0.515" / 13.08mm	0.860" / 21.84mm	0.032" / 0.81mm
F25-3105	0.515" / 13.08mm	0.860" / 21.84mm	0.020" / 0.51mm
F25-3106	0.444" / 11.28mm	0.778" / 19.76mm	0.005" / 0.13mm
F25-3107	0.444" / 11.28mm	0.778" / 19.76mm	0.020" / 0.51mm
F25-3108	0.444" / 11.28mm	0.778" / 19.76mm	0.030" / 0.76mm
F25-3109	0.258" / 6.55mm	0.435" / 11.05mm	0.030" / 0.76mm
F25-3110	0.515" / 13.08mm	0.860" / 21.84mm	0.040" / 1.02mm
F25-3111	0.258" / 6.55mm	0.435" / 11.05mm	0.015" / 0.38mm
F25-3112	0.400" / 10.16mm	0.545" / 13.84mm	0.015" / 0.38mm
F25-3113	0.400" / 10.16mm	0.545" / 13.84mm	0.030" / 0.76mm
F25-3114	0.325" / 8.26mm	0.426" / 10.82mm	0.010" / 0.25mm
F25-3120	0.222" / 5.64mm	0.333" / 8.46mm	0.010" / 0.25mm
F60-3110	0.485" / 12.32mm	0.653" / 16.59mm	0.005" / 0.13mm

Brand	Compressor	Shims
CALSONIC	CWV615	F11-3105, F11-3115, F12-3110
CALSONIC	CWV617	F11-3105, F11-3115, F12-3110
CALSONIC	CWV618	F11-3105, F11-3115, F12-3110
CHRYSLER	6C17	F11-3105, F11-3115
CHRYSLER	A590	F11-3105, F11-3115, F12-3110
CHRYSLER	C171	F11-3105, F11-3115, F12-3110
DELPHI	CVC-125	F25-3109, F25-3111
DELPHI	CVC-135	F25-3109, F25-3111
DELPHI	CVC-135E	F25-3109, F25-3111
DENSO	10P08E	F11-3105, F11-3115
DENSO	10P13A	F11-3105, F11-3115
DENSO	10P13B	F11-3105, F11-3115
DENSO	10P13C	F11-3105, F11-3115
DENSO	10P13E	F11-3105, F11-3115
DENSO	10P13F	F11-3105, F11-3115
DENSO	10P15C	F11-3105, F11-3115
DENSO	10P15E	F11-3105, F11-3115
DENSO	10P15F	F11-3105, F11-3115
DENSO	10P17	F11-3105, F11-3115
DENSO	10P17C	F11-3105, F11-3115
DENSO	10P17VC	F11-3105, F11-3115
DENSO	10PA15A	F11-3105, F11-3115, F12-3110

## Santech Clutch Shim Chart

Brand	Compressor	Shims
DENSO	10PA15C	F11-3105, F11-3115, F12-3110
DENSO	10PA15E	F11-3105, F11-3115, F12-3110
DENSO	10PA15L	F11-3105, F11-3115, F12-3110
DENSO	10PA15LC	F11-3105, F11-3115, F12-3110
DENSO	10PA15SC	F11-3105, F11-3115, F12-3110
DENSO	10PA15VC	F11-3105, F11-3115, F12-3110
DENSO	10PA17A	F11-3105, F11-3115, F12-3110
DENSO	10PA17C	F11-3105, F11-3115, F12-3110
DENSO	10PA17E	F11-3105, F11-3115, F12-3110
DENSO	10PA17H	F11-3105, F11-3115, F12-3110
DENSO	10PA17J	F11-3105, F11-3115, F12-3110
DENSO	10PA17K	F11-3105, F11-3115, F12-3110
DENSO	10PA17VC	F11-3105, F11-3115, F12-3110
DENSO	10PA20C	F11-3105, F11-3115, F12-3110
DENSO	10PA20H	F11-3105, F11-3115, F12-3110
DENSO	10PA20J	F11-3105, F11-3115, F12-3110
DENSO	10S11C	F11-3105, F11-3115, F12-3110
DENSO	10S11P	F11-3105, F11-3115, F12-3110
DENSO	10S13C	F11-3105, F11-3115, F12-3110
DENSO	10S13P	F11-3105, F11-3115, F12-3110
DENSO	10S15C	F11-3105, F11-3115, F12-3110
DENSO	10S15L	F11-3105, F11-3115, F12-3110
DENSO	10S17C	F11-3105, F11-3115, F12-3110
DENSO	10S20C	F11-3105, F11-3115, F12-3110
DENSO	10S20F	F11-3105, F11-3115, F12-3110
DENSO	6E171	F11-3105, F11-3115, F12-3110
DENSO	6E171A	F11-3105, F11-3115, F12-3110
DENSO	6P127A	F11-3105, F11-3115
DENSO	6P127B	F11-3105, F11-3115
DENSO	6P127D	F11-3105, F11-3115
DENSO	6P134	F11-3105, F11-3115
DENSO	6P148	F11-3105, F11-3115
DENSO	6P148A	F11-3105, F11-3115
DENSO	6P148C	F11-3105, F11-3115
DENSO	7SB16C	F11-3105, F11-3115, F12-3110
DENSO	TV10CA	F11-3105, F11-3115, F12-3110
DENSO	TV10CB	F11-3105, F11-3115, F12-3110
DENSO	TV12C(R12)	F11-3105, F11-3115, F12-3110
DENSO	TV12C(R134)	F12-3110
DENSO	TV12EC(R12)	F11-3105, F11-3115, F12-3110
DENSO	TV12SC(R134)	F11-3105, F11-3115, F12-3110
DENSO	TV14C	F11-3105, F11-3115, F12-3110
DENSO	TV14EC	F11-3105, F11-3115, F12-3110
DENSO	TV14SC	F11-3105, F11-3115, F12-3110
DIESEL KIKI	DCV11A	F11-3105, F11-3115, F12-3110
DIESEL KIKI	DCV14A	F11-3105, F11-3115, F12-3110
DIESEL KIKI	DCW17B	F11-3105, F11-3115, F12-3110

## Santech Clutch Shim Chart

Brand	Compressor	Shims
DIESEL KIKI	DCW17D	F11-3105, F11-3115, F12-3110
DIESEL KIKI	DKS13S	F11-3105, F11-3115, F12-3110
DIESEL KIKI	DKS15BH	F11-3105, F11-3115, F12-3110
DIESEL KIKI	DKS15CH	F11-3105, F11-3115, F12-3110
DIESEL KIKI	DKS15G	F11-3105, F11-3115, F12-3110
DIESEL KIKI	DKS15S	F11-3105, F11-3115, F12-3110
DIESEL KIKI	DKS16H(R12)	F11-3105, F11-3115
DIESEL KIKI	DKS16H(R134A)	F11-3105, F11-3115
DIESEL KIKI	DKS17CH	F11-3105, F11-3115, F12-3110
DIESEL KIKI	DKS17G (DUAL)	F11-3105, F11-3115, F12-3110
DIESEL KIKI	DKS17G (SINGLE)	F11-3105, F11-3115, F12-3110
DIESEL KIKI	DKS17S	F11-3105, F11-3115, F12-3110
DIESEL KIKI	DKV11A	F11-3105, F11-3115, F12-3110
DIESEL KIKI	DKV11G	F25-3109, F25-3111
DIESEL KIKI	DKV14G	F25-3109, F25-3111
FORD	FS10	F12-3110
FORD	FS6	F11-3105, F11-3115
FORD	FS6 CROSS MOUNT	F11-3105, F11-3115
FORD	FX15	F12-3110
FORD	SCROLL	F25-3112, F25-3113
HITACHI	A5000	F11-3105, F11-3115
HITACHI	MJ110	F11-3105, F11-3115
HITACHI	MJ123	F11-3105, F11-3115
HITACHI	MJ167	F11-3105, F11-3115
HITACHI	MJS130	F11-3105, F11-3115
HITACHI	MJS170	F11-3105, F11-3115
HITACHI	SWP123	F11-3105, F11-3115
HITACHI	SWP167	F11-3105, F11-3115
KEIHIN	150L	F60-3110
KEIHIN	150R	F60-3110
MATS/PAN	H12A1AH4DX	F25-3109, F25-3111
MATS/PAN	N1300AC4	F12-3110
MATS/PAN	N1301AB4	F12-3110
MATS/PAN	N1301AD4	F12-3110
MATS/PAN	N1301AE4	F12-3110
MATS/PAN	NL1300AA4	F12-3110
MATS/PAN	NL1300AB4	F12-3110
MATS/PAN	NL1300AE4	F12-3110
MATS/PAN	S1150F3	F12-3110
MATS/PAN	S1150X3	F12-3110
MATS/PAN	SA1150AE4	F12-3110
MITSUBISHI	AX105VSR	F25-3112, F25-3113
MITSUBISHI	FX105V	F25-3112, F25-3113
MITSUBISHI	FX80	F25-3112, F25-3113
MITSUBISHI	FXA105VS	F25-3112, F25-3113
MITSUBISHI	FXA105VSLR	F25-3112, F25-3113
MITSUBISHI	FXA105VSR	F25-3112, F25-3113

## Santech Clutch Shim Chart

Brand	Compressor	Shims
MITSUBISHI	FXA105VSSS	F25-3112, F25-3113
NIHON	DKV14B	F11-3105, F11-3115, F12-3110
NIHON	DKV14C	F11-3105, F11-3115, F12-3110
SANDEN	PXE13	F25-3114
SANDEN	PXE16	F25-3114
SANDEN	PXV16	F25-3114
SANDEN	SD505	F25-3106, F25-3107, F25-3108
SANDEN	SD507	F25-3101, F25-3104, F25-3105, F25-3110
SANDEN	SD507A2	F25-3101, F25-3104, F25-3105, F25-3110
SANDEN	SD508	F25-3101, F25-3104, F25-3105, F25-3110
SANDEN	SD510	F25-3101, F25-3104, F25-3105, F25-3110
SANDEN	SD5H09	F25-3101, F25-3104, F25-3105, F25-3110
SANDEN	SD5H13	F25-3101, F25-3104, F25-3105, F25-3110
SANDEN	SD708	F25-3101, F25-3104, F25-3105, F25-3110
SANDEN	SD709	F25-3101, F25-3104, F25-3105, F25-3110
SANDEN	SD709CA	F25-3101, F25-3104, F25-3105, F25-3110
SANDEN	SD709CP	F25-3101, F25-3104, F25-3105, F25-3110
SANDEN	SD7B10	F25-3101, F25-3104, F25-3105, F25-3110
SANDEN	SD7C16	F60-3110
SANDEN	SD7H15	F25-3114
SANDEN	SD7V16	F60-3110
SANDEN	TR090	F25-3112, F25-3113
SANDEN	TR105	F25-3112, F25-3113
SANDEN	TR105VS	F25-3112, F25-3113
SANDEN	TR70	F25-3120
SANDEN	TRF090	F25-3112, F25-3113
SANDEN	TRF105	F25-3112, F25-3113
SANDEN	TRS090	F25-3112, F25-3113
SANDEN	TRS105	F25-3112, F25-3113
SANDEN	TRSA09	F25-3112, F25-3113
SANDEN	TRSA12	F25-3112, F25-3113
SANDEN	TRSE07	F25-3112, F25-3113
SEIKO-SEIKI	SS170PSS	F12-3110
VISTEON	HS090L	F25-3112, F25-3113
VISTEON	HS090R	F25-3112, F25-3113
VISTEON	HS110R	F25-3112, F25-3113
VISTEON	HS15	F12-3110
VISTEON	HS17	F12-3110
VISTEON	HS18	F12-3110
VISTEON	VS16	F25-3109, F25-3111

## Bearings

### B10-2110

Case Bearing

16mm x 23mm x 21.9mm



**Chrysler** A590, C171

**Denso** 10P15 Series, 10P17 Series, 10PA15 Series, 10PA17 Series, 10PA20C, 10PA20H, 10PA20J, 10PA20SC, 10PA20SH, 10PA20VC, 10S15C, 10S15L, 10S17C, 10S20C, 10S20F, 10S20H, 6E171, 6E171A, 6P134, 6P148, 6P148A, 6P148C

**Ford** FS6, FS6 CROSS MOUNT

### B11-2101

Case Bearing

25mm x 56mm x 15mm



**Chrysler** RV2

### B11-2110

Case Bearing

16.3mm x 22mm x 16mm



**Chrysler** A590, C171

**Diesel Kiki** DKS13G (DUAL), DKS13G (SINGLE), DKS13S, DKS15G, DKS15S, DKS17G (DUAL), DKS17G (SINGLE)

**Ford** FS6, FS6 CROSS MOUNT

**Sanden** PXE16, PXV16

### B12-3103

Case Bearing

16.1mm x 18.1mm x 20mm



**Ford** FS10, FX15

**Visteon** HS15, HS17, HS18

### B13-2111

Case Bearing

19mm x 26.2mm x 12.5mm



**GM/Harrison** R4

### B13-2120

Case Bearing

14.3mm x 19.1mm x 15.7mm



**GM/Harrison** DA6, HD6, HR6, HR6HE, HT6

### B13-2130

Case Bearing

15.9mm x 21mm x 12.5mm



**Calsonic** V5-15C, V5-15F, V5-15G

**GM/Harrison** A6, V5, V5 (DESTROKER)

### B13-2132

Case Bearing

15.9mm x 21.3mm x 12.7mm



**Calsonic** V5-15C, V5-15F, V5-15G

**Daewoo** V5

**GM/Harrison** V5, V5 (DESTROKER)

### B13-2133

Case Bearing

14.3mm x 20.6mm x 15.7mm



**Ford** F500

**GM/Harrison** V5, V5 (DESTROKER), V7

**Visteon** VS16, VS18M

### B13-2134

Case Bearing

Front Nose Bearing (15.9mm x 22.3mm x 15.8mm)



**GM/Harrison** V7

### B13-2135

Case Bearing

16.1mm x 18.1mm x 20mm



**GM/Harrison** HU6

### B20-2000

Case Bearing

15mm x 23mm x 16mm



**Denso** 10PA15 Series, 10PA17 Series, 10PA20C, 10PA20H, 10PA20J, 10PA20SC, 10PA20SH, 10PA20VC, 10S11C, 10S11P, 10S13C, 10S13P, 10S15C, 10S15L, 10S17C, 10S20C, 10S20F, 10S20H, 6SEU12, 7SB16C, 7SBU16C

### B20-2110

Case Bearing

16mm x 23mm x 16mm



**Calsonic** CWV615, CWV617, CWV618

**Delphi** SP10, SP15

**Denso** 10P08E, 10P13 Series, 10P17 Series, 6P127A, 6P127B, 6P127D

**Hitachi** A5000, MJ110, MJ123, MJ167, MJS130, MJS170, SWP123, SWP167

**Tama** TM08HD

### B25-2110

Case Bearing

20mm x 27.1mm x 30mm



**Sanden** SD510, SD7H15

### B25-2111

Case Bearing

12mm x 28mm x 8mm



**Ford** LARGE SCROLL, SCROLL

**Mitsubishi** AX105VSR, FX105V, FX80, FXA105VS, FXA105VSLR, FXA105VSR, FXA105VSSS, MSC105CVS, MSC130CVSG, MSC130CVSG2, MSC90, MSC90C

**Sanden** TR090, TRF090, TRS090, TRSA09, TRSA12

**Visteon** HS090L, HS090R, HS110R

### B25-2112

Case Bearing

10mm x 26mm x 8mm



**Sanden** TR105, TR105VS, TR70, TRF105, TRS105, TRSE07

### B25-2113

Case Bearing

16mm x 22mm x 16mm



**Delphi** CVC-125, CVC-135, CVC-135E

**Sanden** SD7C16, SD7V16

### B25-2114

Case Bearing

10mm x 28mm x 8mm



**Sanden** TRSE07

### B30-2000

Case Bearing

16mm x 22mm x 20mm



**Diesel Kiki** DKS15CH, DKS17CH, DKS17S

### B40-2110

Case Bearing

17mm x 40mm x 12mm



**Keihin** 150L, 150R

**Tecumseh** HG1000, HG850

**York** 206, 209, 210

### B40-2112

Case Bearing

30mm x 62mm x 11.3mm



**Tecumseh** HG1000, HG850

**York** 206, 209, 210

### B10-1105

Clutch Bearing

30mm x 62mm x 16mm-24mm



**Tecumseh** HG1000, HG500, HG850

**York** 206, 209, 210

### B10-1107

Clutch Bearing

35mm x 55mm x 20mm



























**Calsonic** CR14, CSV613, CWV615, CWV617, CWV618, DKV14D



## Bearings

<p><b>Diesel Kiki</b> DCV11A, DCV14A, DCV14J, DCW17B, DCW17D, DKS13CH, DKS13G (DUAL), DKS13G (SINGLE), DKS13S, DKS15BH, DKS15CH, DKS15G, DKS15S, DKS17CH, DKS17D, DKS17G (DUAL), DKS17G (SINGLE), DKS17S, DKV11A, DKV11G, DKV14G, DKV14J</p> <p><b>Hadsys</b> RC17D, RC17S</p> <p><b>Mats/Pan</b> N1300AC4, N1301AB4, N1301AD4, N1301AE4, NL1300AA4, NL1300AB4, NL1300AE4</p> <p><b>Sanden</b> SD505, SD5H09, SD5H11, SD5H13, SD6V12, SD708, SD709, SD709CA, SD709CP, SD7H15, SD7V16, TR090, TRF090, TRS090, TRSA09, TRSE07</p> <p><b>Seiko-Seiki</b> SS121DN1, SS121DN2, SS121DV2</p> <p><b>Tama</b> TM08HD</p> <p><b>Visteon</b> VS16</p> <p><b>Zexel</b> DCS17IC</p>	<p><b>B20-1105</b> Clutch Bearing 38mm x 54mm x 17mm</p> <p><b>Delphi</b> SP10 <b>Denso</b> 10P08E</p> <p><b>B20-1106</b> Clutch Bearing 30mm x 52mm x 22mm</p> <p><b>Denso</b> 10PA15 Series, 10PA17 Series, 10PA20C, 10PA20H, 10PA20J, 10PA20SC, 10PA20SH, 10PA20VC, 10S13C, 10S13P, 10S15C, 10S15L, 10S17C, 10S20C, 10S20F, 10S20H, 10SR15C, 10SR17C, TV10 Series, TV12 Series, TV14 Series</p> <p><b>B20-1107</b> Clutch Bearing 40mm x 57mm x 20mm-24mm</p> <p><b>Denso</b> 10P17C</p> <p><b>B20-1108</b> Clutch Bearing 35mm x 52mm x 22mm</p> <p><b>Delphi</b> CVC-165, CVC-185, CVC7P <b>Denso</b> 10PA15C, 10PA17C, 6CA17C, 6SEU12, 6SEU12C, 6SEU14C, 7SB16C, 7SBU16C, 7SBU17C, 7SEU16</p> <p><b>GM/Harrison</b> HT6 <b>Visteon</b> VS18M</p> <p><b>B20-1109</b> Clutch Bearing 35mm x 52mm x 20mm</p> <p><b>Denso</b> 7SE16, SC08 (ITALY), SC08C (SPAIN), SC08C (USA) <b>Ford</b> F500 <b>Sanden</b> PXE13, PXE16, PXV16, SD7C16 <b>Visteon</b> VS12M <b>Zexel</b> DCS17E</p> <p><b>B20-1110</b> Clutch Bearing 30mm x 52mm x 20mm</p> <p><b>Denso</b> 10S11C, 10S11P, SCS06C</p> <p><b>B20-1112</b> Clutch Bearing 30mm x 47mm x 20mm</p> <p><b>Denso</b> SC06SA</p>	<p><b>B20-1113</b> Clutch Bearing 30mm x 47mm x 12mm</p> <p><b>Denso</b> SC06SA, SCS06C</p> <p><b>B20-1115</b> Clutch Bearing 35mm x 52mm x 12mm</p> <p><b>Denso</b> 5SE09C, 5SE12C, 5SL12CJ, 6SEU16, 7SE16, 7SEU16, 7SEU17C</p> <p><b>B20-1906</b> Clutch Bearing 30mm x 52mm x 22mm</p> <p><b>Denso</b> 10PA15 Series, 10PA17 Series, 10PA20C, 10S13C, 10S13P, 10S15C, 10S15L, 10S17C, 10S20C</p> <p><b>B25-1100</b> Clutch Bearing 40mm x 62mm x 24mm</p> <p><b>Calsonic</b> CWV615, CWV617, CWV618 <b>Denso</b> 10P13 Series, 10P15 Series, 10P17 Series <b>Hitachi</b> MJS170 <b>Mitsubishi</b> MSC105CVS, MSC90, MSC90C <b>Nihon</b> DKV14C <b>Sanden</b> SD507, SD507A2, SD508, SD510 <b>Seiko-Seiki</b> SS170PSS</p> <p><b>B25-1101</b> Clutch Bearing 30mm x 47mm x 18mm</p> <p><b>Sanden</b> TR70</p> <p><b>B25-1102</b> Clutch Bearing 35mm x 50mm x 20mm</p> <p><b>Delphi</b> CVC-125, CVC-135, CVC-135E, CVC6 <b>Ford</b> LARGE SCROLL, SCROLL <b>Mitsubishi</b> MSC130CVSG, MSC130CVSG2 <b>Sanden</b> SD7B10, TR090, TR105, TR105VS, TRF090, TRF105, TRS090, TRS105, TRSA12 <b>Visteon</b> HS090L, HS090R, HS110R</p> <p><b>B25-1103</b> Clutch Bearing 32mm x 47mm x 18mm</p> <p><b>Mats/Pan</b> H12A1AH4DX <b>Seiko-Seiki</b> SS10LV6, SS10V1, SS10V6</p>
<p><b>B10-1110</b> Clutch Bearing 40mm x 62mm x 20.6mm-24mm</p> <p><b>Chrysler</b> 6C17, A590, C171 <b>Denso</b> 6E171, 6E171A, 6P Series <b>Ford</b> FS6, FS6 CROSS MOUNT <b>Mitsubishi</b> FX105V, FX80</p>	<p><b>B11-1100</b> Clutch Bearing 30mm x 62mm x 27mm</p> <p><b>Chrysler</b> RV2</p>	<p><b>B12-1120</b> Clutch Bearing 30mm x 55mm x 23mm</p> <p><b>Behr</b> WINGCELL <b>Bosch</b> AXIAL <b>Diesel Kiki</b> DKS16H(R12), DKS16H(R134A) <b>Ford</b> FS10, FS18, FX15 <b>Nihon</b> DKV14B, NVR140S <b>Visteon</b> HS15, HS17, HS18</p>
<p><b>B13-1110</b> Clutch Bearing 40mm x 62mm x 20.6mm</p> <p><b>Calsonic</b> V5-15C, V5-15F, V5-15G <b>Daewoo</b> V5 <b>GM/Harrison</b> A6, DA6, HD6, HR6, HR6HE, HT6, HU6, R4, V5, V5 (DESTROKER), V7 <b>Keihin</b> 150L, 150R</p>		

## Bearings

<b>B25-1104</b> 35mm x 48mm x 20mm  <b>Sanden</b> TRSE07	<b>B13-3115</b> Needle Bearings  <b>GM/Harrison R4</b>	<b>B20-3127</b> 17mm x 34mm x 2.4mm  <b>Delphi</b> SP15 <b>Denso</b> 10P17 Series, 10PA15 Series, 10PA17 Series, 10PA20C, 10PA20H, 10PA20J, 10PA20SC, 10PA20SH, 10PA20VC, 6P127A, 6P127B, 6P127D, 6P148, 6P148A, 6P148C
<b>B30-1120</b> 35mm x 62mm x 28mm  <b>Diesel Kiki</b> DKS15BH, DKS15CH	<b>B13-3105</b> 14.7mm x 29mm x 2.4mm  <b>GM/Harrison DA6, HR6, HR6HE</b>	<b>B25-3110</b> 57.2mm x 79.4mm x 3.2mm  <b>Calsonic</b> V5-15C, V5-15F, V5-15G <b>Daewoo</b> V5 <b>Delphi</b> CVC-125, CVC-135, CVC6 <b>GM/Harrison</b> V5, V5 (DESTROKER) <b>Sanden</b> SD505, SD507, SD507A2, SD508, SD510
<b>B30-1121</b> 40mm x 68mm x 30mm  <b>B40-2114</b> 62mm x 30mm x 16mm 	<b>B13-3106</b> 16mm x 35mm x 4.8mm  <b>Calsonic</b> CSV613 <b>Daewoo</b> V5 <b>Delphi</b> CVC-125, CVC-135, CVC-135E, CVC6 <b>GM/Harrison</b> V5, V5 (DESTROKER), V7 <b>Sanden</b> SD7C16	<b>B25-3115</b> 70.2mm x 89.7mm x 3.2mm  <b>Sanden</b> SD505, SD507, SD507A2, SD508, SD510
<b>B50-1100</b> 32mm x 55mm x 23mm  <b>Mats/Pan</b> N1300AC4, N1301AB4, N1301AD4, N1301AE4, NL1300AA4, NL1300AB4, NL1300AE4, S1150F3, S1150X3, SA1150AE4 <b>Seiko-Seiki</b> SS96D1, SS96D2	<b>B13-3107</b> 16mm x 33mm x 4mm  <b>GM/Harrison V5, V5 (DESTROKER)</b>	<b>B65-3110</b> 20.1mm x 34.7mm x 2mm  <b>Hitachi</b> A5000, MJ110, MJ123, MJ167, MJS130, MJS170, SWP123, SWP167
<b>B55-1100</b> 40mm x 66mm x 24mm  <b>Mitsubishi</b> MSC105CVS, MSC90, MSC90C	<b>B13-3110</b> 19.2mm x 37.2mm x 2mm  <b>Diesel Kiki</b> DKS15BH, DKS15CH <b>GM/Harrison A6</b>	<b>B75-3100</b> 45mm x 65mm x 3mm  <b>Calsonic</b> CSV613
<b>B70-1100</b> 35mm x 62mm x 24mm  <b>Diesel Kiki</b> DCW17B, DCW17D	<b>B13-3121</b> 14.7mm x 40.8mm x 3mm  <b>GM/Harrison HD6, HT6</b>	<b>B13-6100</b> 55.7mm x 76.9mm x 4.74mm (Set)  <b>Calsonic</b> V5-15C, V5-15F, V5-15G <b>Daewoo</b> V5 <b>GM/Harrison</b> V5, V5 (DESTROKER)
<b>B70-1101</b> 35mm x 55mm x 22mm  <b>Zexel</b> DCS17EC	<b>B20-3115</b> 17.3mm x 34mm x 3mm  <b>Denso</b> 10P13 Series, 10P15 Series, 10PA15 Series, 10PA17 Series, 10PA20C, 10PA20H, 10PA20J, 10PA20SC, 10PA20SH, 10PA20VC, 10S11C, 10S11P, 10S13C, 10S13P, 10S15C, 10S15L, 10S17C, 10S20C, 10S20F, 10S20H <b>Ford</b> FS10, FS18, FX15	<b>B13-6101</b> 54.1mm x 76.8mm x 4.74mm (Set) (Protruding Inner Race)  <b>GM/Harrison V7</b>
<b>B95-1102</b> 40mm x 57mm x 24mm  <b>Mitsubishi</b> AX105VSR, FXA105VS, FXA105VSLR, FXA105VSR, FXA105VSSS <b>Sanden</b> SD507, SD507A2, SD508, SD510	<b>B20-6100</b> 10mm x 24.9mm x 3.98mm (Set thickness)  <b>Denso</b> 7SB16C	

## Bearings

### B25-6101-25 Thrust Bearing Set

Sets of 25



**Sanden** SD507, SD507A2, SD508,  
SD510, SD5H09, SD5H11, SD5H13,  
SD7H15

### B25-6102-25 Thrust Bearing Set

Sets of 25



**Sanden** SD507, SD507A2, SD508,  
SD5H09, SD5H11, SD5H13, SD7H15

### B25-6103-25 Thrust Bearing Set

Sets of 25



**Sanden** SD510, SD708, SD709,  
SD709CA, SD709CP

### B10-4101 Thrust Race

0.1062" - 2.70mm



**Chrysler** A590, C171  
**Ford** FS6, FS6 CROSS MOUNT

### B10-4102 Thrust Race

0.1068" - 2.71mm



**Chrysler** A590, C171  
**Ford** FS6, FS6 CROSS MOUNT

### B10-4109 Thrust Race

0.1090" - 2.77mm



**Chrysler** A590, C171  
**Ford** FS6, FS6 CROSS MOUNT

### B13-4110 Thrust Race

0.0920" - 2.34mm



**GM/Harrison A6**

### B13-4117 Thrust Race

0.1015" - 2.58mm



**GM/Harrison A6**

### B13-4118 Thrust Race

0.1025" - 2.60mm



**GM/Harrison A6**

### B13-4132 Thrust Race

0.0839" - 2.13mm



**GM/Harrison DA6, HR6, HR6HE**

### B13-4134 Thrust Race

0.0864" - 2.19mm



**GM/Harrison DA6, HR6, HR6HE**

### B13-4135 Thrust Race

0.0872" - 2.21mm



**GM/Harrison DA6, HR6, HR6HE**

### B13-4139 Thrust Race

0.0903" - 2.29mm



**GM/Harrison DA6, HR6, HR6HE**

### B13-4144 Thrust Race

73.4mm x 99.8mm x 0.8mm



**Sanden** SD709, SD709CA, SD709CP

### B20-4100 Thrust Race

Thrust Race (Early) (Cylinder  
Side) (17mm x 34mm x  
2.24mm)



**Denso** 10PA15 Series, 10PA17  
Series, 10PA20C, 10PA20H, 10PA20J,  
10PA20SC, 10PA20SH, 10PA20VC

### B20-4101 Thrust Race

Thrust Race (Early) (Swash  
Plate Side) (17mm x 37mm x  
2.24mm)



**Denso** 10PA15 Series, 10PA17  
Series, 10PA20C, 10PA20H, 10PA20J,  
10PA20SC, 10PA20SH, 10PA20VC

### B65-4100 Thrust Race

0.0905" - 2.30mm



**Hitachi** A5000, MJ110, MJ123,  
MJ167, MJS130, MJS170, SWP123,  
SWP167

## Chemicals

### A10-5118

#### Adhesives

2 fl. oz.-Use for Loctite Black Max and Omnifit 5181



**Mats/Pan** N1300AC4, N1301AB4, N1301AD4, N1301AE4, NL1300AA4, NL1300AB4, NL1300AE4, SA1150AE4

### A10-5120

#### Adhesives

50 ml. (Tube)-Gland Sealant for Rubber Gaskets



### MT3012

#### Bottle, Oil

Ultra PAG 46 - 6pk, 8 oz Bottle



**Bosch** AXIAL  
**Calsonic** V5-15C  
**Chrysler** 6C17, A590, C171, RV2  
**Delphi** CVC-165, CVC-185, CVC7P, SP15  
**Denso** 10P08E, 10P13 Series, 10P15 Series, 10P17 Series, 10PA15 Series, 10PA17 Series, 10PA20C, 10PA20H, 10PA20J, 10PA20SC, 10PA20SH, 10PA20VC, 10S11C, 10S11P, 10S13C, 10S13P, 10S15C, 10S15L, 10S17C, 10S20C, 10S20F, 10S20H, 10SR15C, 10SR17

**Diesel Kiki** DCW17B, DCW17D, DKS13CH, DKS13G (DUAL), DKS13G (SINGLE), DKS15CH, DKS17CH, DKS17D, DKS17G (DUAL), DKS17G (SINGLE)

**Ford** F500, FS10, FS6, FS6 CROSS MOUNT, FX15, LARGE SCROLL, SCROLL

**Hadsys** RC17D, RC17S

**Hitachi** A5000, MJ110, MJ123, MJ167, MJS130, MJS170, SWP123, SWP167

**Mats/Pan** H12A1AH4DX, N1300AC4, N1301AB4, N1301AD4, N1301AE4, NL1300AA4, NL1300AB4, NL1300AE4, S1150F3, S1150X3, SA1150AE4

**Mitsubishi** AX105VSL, AX105VSR, FX105V, FX80, FXA105VS, FXA105VSLR, FXA105VSR, FXA105VSS, FXA105VSSS, MSC105CVS, MSC105VSR, MSC130CVSG, MSC130CVSG2, MSC90, MSC90C

**Nihon** NVR140S

**Sanden** PXE13, PXE16, SD7C16, TR090, TR105, TR105VS, TR70, TRF090, TRF105, TRS090, TRS105, TRSA09, TRSA12, TRSE07

**Tama** TM08HD

**Tecumseh** HG1000, HG500, HG850

**Visteon** HS090L, HS090R, HS110R, HS15, HS17, HS18, VS18, VS18M  
**York** 206, 209, 210, SC206, SC209  
**Zexel** DCS17E

### MT3013

#### Bottle, Oil

Ultra PAG 100 - 6pk, 8 oz Bottle



**Behr** WINGCELL  
**Calsonic** CR14, CWV615, CWV617, CWV618, DKV14D

**Daewoo** V5

**Delphi** SP10

**Denso** 5SL12CJ, TV10 Series, TV12 Series, TV14 Series

**Diesel Kiki** DCV11A, DCV14A, DCV14J, DKS13S, DKS15BH, DKS15G, DKS15S, DKS16H(R12), DKS16H(R134A), DKS17S, DKV11A, DKV11G, DKV14G, DKV14J

**Keihin** 150L, 150R

**Nihon** DKV14B, DKV14C

**Sanden** SD505, SD507, SD507A2, SD508, SD510, SD5H09, SD5H11, SD5H13, SD6V12, SD708, SD709, SD709CA, SD709CP, SD7B10, SD7H13, SD7H15, SD7V16

**Seiko-Seiki** SS10LV6, SS10V1, SS10V6, SS121DN1, SS121DN2, SS121DV2, SS170PSS, SS96D1, SS96D2

### MT3014

#### Bottle, Oil

Ultra PAG 150 - 6pk, 8 oz Bottle



**Calsonic** CSV613

**Delphi** CVC-125, CVC-135, CVC-135E

**Diesel Kiki** DCV11D, DKV11D

**GM/Harrison** A6, DA6, HD6, HR6, HR6HE, HT6, HU6, R4, V5, V5 (DESTROKER), V7, V7 (DESTROKER)

### MT3018

#### Bottle, Oil

Ultra PAG 46 - 6pk, Quart Bottle



**Bosch** AXIAL

**Calsonic** V5-15C

**Chrysler** 6C17, A590, C171, RV2

**Delphi** CVC-165, CVC-185, CVC7P, SP15

**Denso** 10P08E, 10P13 Series, 10P15 Series, 10P17 Series, 10PA15 Series, 10PA17 Series, 10PA20C, 10PA20H, 10PA20J, 10PA20SC, 10PA20SH, 10PA20VC, 10S11C, 10S11P, 10S13C, 10S13P, 10S15C, 10S15L, 10S17C, 10S20C, 10S20F, 10S20H, 10SR15C, 10SR17

**Diesel Kiki** DCW17B, DCW17D, DKS13CH, DKS13G (DUAL), DKS13G (SINGLE), DKS15CH, DKS17CH, DKS17D, DKS17G (DUAL), DKS17G (SINGLE)

**Ford** F500, FS10, FS6, FS6 CROSS MOUNT, FX15, LARGE SCROLL, SCROLL

**Hadsys** RC17D, RC17S

**Hitachi** A5000, MJ110, MJ123, MJ167, MJS130, MJS170, SWP123, SWP167

**Mats/Pan** H12A1AH4DX, N1300AC4, N1301AB4, N1301AD4, N1301AE4, NL1300AA4, NL1300AB4, NL1300AE4, S1150F3, S1150X3, SA1150AE4

**Mitsubishi** AX105VSL, AX105VSR, FX105V, FX80, FXA105VSLR, FXA105VSR, FXA105VSS, FXA105VSSS, MSC105CVS, MSC105VSR, MSC130CVSG, MSC130CVSG2, MSC90, MSC90C

**Nihon** NVR140S

**Sanden** PXE13, PXE16, SD7C16, TR090, TR105, TR105VS, TR70, TRF090, TRF105, TRS090, TRS105, TRSA09, TRSA12, TRSE07

**Tama** TM08HD

**Tecumseh** HG1000, HG500, HG850

**Visteon** HS090L, HS090R, HS110R, HS15, HS17, HS18, VS18, VS18M

**York** 206, 209, 210, SC206, SC209

**Zexel** DCS17E

### MT3019

#### Bottle, Oil

Ultra PAG 100 - 6pk, Quart Bottle



**Behr** WINGCELL

**Calsonic** CR14, CWV615, CWV617, CWV618, DKV14D

**Daewoo** V5

**Delphi** SP10

**Denso** 5SL12CJ, TV10 Series, TV12 Series, TV14 Series

**Diesel Kiki** DCV11A, DCV14A, DCV14J, DKS13S, DKS15BH, DKS15G, DKS15S, DKS16H(R12), DKS16H(R134A), DKS17S, DKV11A, DKV11G, DKV14G, DKV14J

**Keihin** 150L, 150R

**Nihon** DKV14B, DKV14C

**Sanden** SD505, SD507, SD507A2, SD508, SD510, SD5H09, SD5H11, SD5H13, SD6V12, SD708, SD709, SD709CA, SD709CP, SD7B10, SD7H13, SD7H15, SD7V16

**Seiko-Seiki** SS10LV6, SS10V1, SS10V6, SS121DN1, SS121DN2, SS121DV2, SS170PSS, SS96D1, SS96D2

## Chemicals

### MT3020 Bottle, Oil

Ultra PAG 150 - 6pk, Quart Bottle



- Calsonic** CSV613
- Delphi** CVC-125, CVC-135, CVC-135E
- Diesel Kiki** DCV11D, DKV11D
- GM/Harrison** A6, DA6, HD6, HR6, HR6HE, HT6, HU6, R4, V5, V5 (DESTROKER), V7, V7 (DESTROKER)

### MT3024 Bottle, Oil

Ester 100 Viscosity w/ UV Dye - 8 oz Bottle



### MT3025 Bottle, Oil

Ester 100 Viscosity w/ UV Dye - Quart Bottle



### A10-6163 Drum - Oil

Ultra PAG 46 - 52 gal Drum



- Bosch** AXIAL
- Calsonic** V5-15C
- Chrysler** 6C17, A590, C171, RV2
- Delphi** CVC-165, CVC-185, CVC7P, SP15
- Denso** 10P08E, 10P13 Series, 10P15 Series, 10P17 Series, 10PA15 Series, 10PA17 Series, 10PA20C, 10PA20H, 10PA20J, 10PA20SC, 10PA20SH, 10PA20VC, 10S11C, 10S11P, 10S13C, 10S13P, 10S15C, 10S15L, 10S17C, 10S20C, 10S20F, 10S20H, 10SR15C, 10SR17
- Diesel Kiki** DCW17B, DCW17D, DKS13CH, DKS13G (DUAL), DKS13G (SINGLE), DKS15CH, DKS17CH, DKS17D, DKS17G (DUAL), DKS17G (SINGLE)
- Ford** F500, FS10, FS6, FS6 CROSS MOUNT, FX15, LARGE SCROLL, SCROLL
- Hadsys** RC17D, RC17S
- Hitachi** A5000, MJ110, MJ123, MJ167, MJS130, MJS170, SWP123, SWP167
- Mats/Pan** H12A1AH4DX, N1300AC4, N1301AB4, N1301AD4, N1301AE4, NL1300AA4, NL1300AB4, NL1300AE4, S1150F3, S1150X3, SA1150AE4
- Mitsubishi** AX105VSL, AX105VSR, FX105V, FX80, FXA105VS, FXA105VSLR, FXA105VSS, FXA105VSSS, MSC105CVS, MSC105VSR, MSC130CVSG, MSC130CVSG2, MSC90, MSC90C

- Nihon** NVR140S
- Sanden** PXE13, PXE16, SD7C16, TR090, TR105, TR105VS, TR70, TRF090, TRF105, TRS090, TRS105, TRSA09, TRSA12, TRSE07

- Tama** TM08HD
- Tecumseh** HG1000, HG500, HG850
- Visteon** HS090L, HS090R, HS110R, HS15, HS17, HS18, VS18, VS18M
- York** 206, 209, 210, SC206, SC209
- Zexel** DCS17E

### A10-6164 Drum - Oil

Ultra PAG 100 - 52 gal Drum



- Behr** WINGCELL
- Calsonic** CR14, CWV615, CWV617, CWV618, DKV14D
- Daewoo** V5
- Delphi** SP10
- Denso** 5SL12CJ, TV10 Series, TV12 Series, TV14 Series
- Diesel Kiki** DCV11A, DCV14A, DCV14J, DKS13S, DKS15BH, DKS15G, DKS15S, DKS16H(R12), DKS16H(R134A), DKS17S, DKV11A, DKV11G, DKV14G, DKV14J
- Keihin** 150L, 150R
- Nihon** DKV14B, DKV14C
- Sanden** SD505, SD507, SD507A2, SD508, SD510, SD5H09, SD5H11, SD5H13, SD6V12, SD708, SD709, SD709CA, SD709CP, SD7B10, SD7H13, SD7H15, SD7V16
- Seiko-Seiki** SS10LV6, SS10V1, SS10V6, SS121DN1, SS121DN2, SS121DV2, SS170PSS, SS96D1, SS96D2

### A10-6165 Drum - Oil

Ultra PAG 150 - 52 gal Drum



- Calsonic** CSV613
- Delphi** CVC-125, CVC-135, CVC-135E, CVC6
- Diesel Kiki** DCV11D, DKV11D
- GM/Harrison** A6, DA6, HD6, HR6, HR6HE, HT6, HU6, R4, V5, V5 (DESTROKER), V7, V7 (DESTROKER)

### A10-6174 Drum - Oil

Mineral Oil 32 Viscosity - 55 Gallon Drum



### A10-6176 Drum - Oil

Ester Oil - 55 Gallon Drum



## Coil Clock Position

All O-Rings Are Actual Size

### COIL CLOCK POSITION

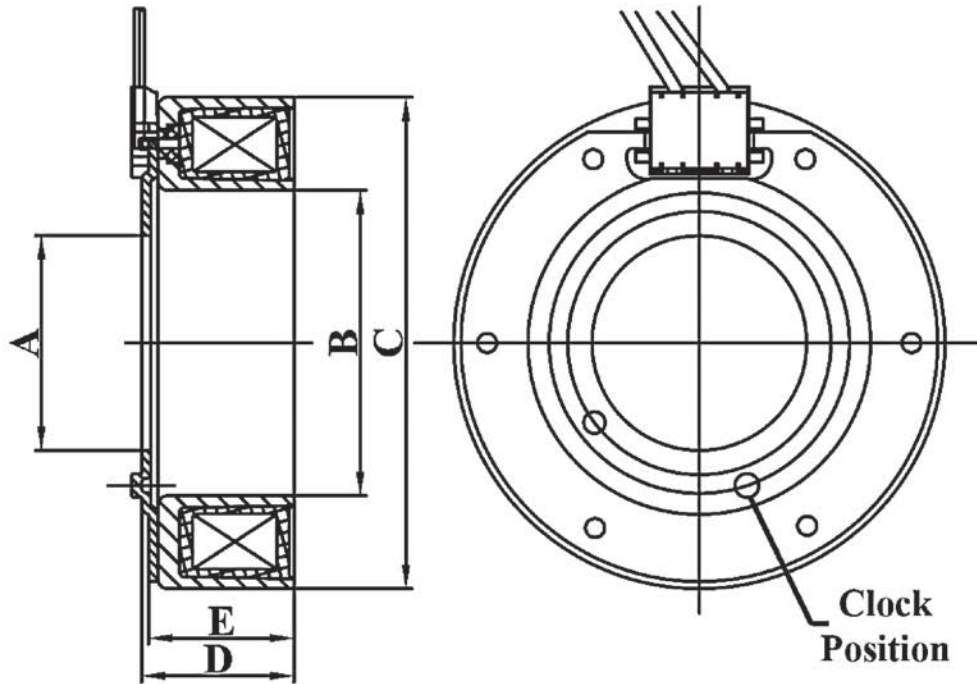

The Coil Clock Position is determined by placing the connector where the wires exit the Coil Housing at the 12:00 O'Clock position and rotating clockwise until the Coil Position Locator is located. The Clock Position is given by where on a clock face the Coil Position Locator is located. The Clock Position of the Coil shown would be 5:30.

## Hub Offset

All O-Rings Are Actual Size

# HUB OFFSET

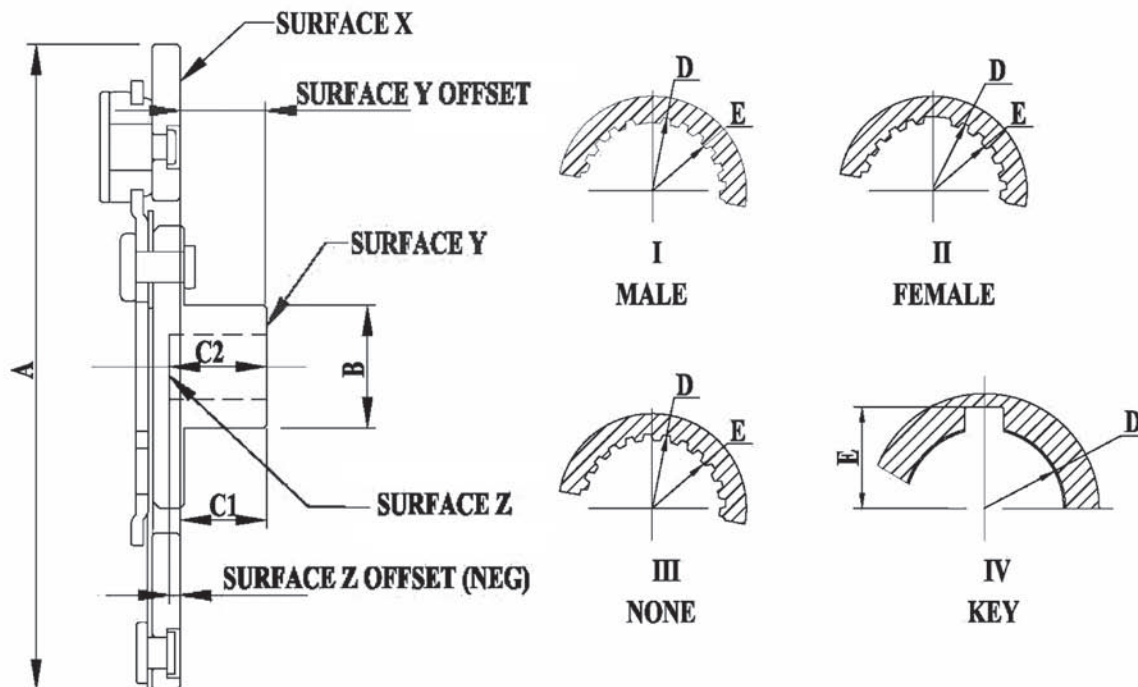

1. SURFACE X - PULLEY FRICTION CONTACT SURFACE.
  2. SURFACE Y - SHIMMED SURFACE ON SOME HUBS.
  3. SURFACE Z - SHIMMED SURFACE ON SOME HUBS.
  4. OFFSET IS THE DISTANCE BETWEEN THE SHIMMED SURFACE AND THE PULLEY CONTACT SURFACE.
  5. IF SHIMMED SURFACE IS SURFACE Y, THE OFFSET IS C1.
  6. IF SHIMMED SURFACE IS SURFACE Z, THE OFFSET IS C1 - C2.
- A. A POSITIVE OFFSET MEANS THE OFFSET IS ON THE RIGHT SIDE OF SURFACE X IN THE DRAWING ABOVE.
- B. A NEGATIVE OFFSET MEANS THE OFFSET IS ON THE LEFT SIDE OF SURFACE X IN THE DRAWING ABOVE.

## Pully Offset

Pully Offset is defined as the Distance from the Center of the Grooves, or Belt, to the Surface on the Nose of the Compressor that limits the position of the Pulley on the Nose. The Bearing ID Edge on the Rear of the Pulley is what mates to the Nose Surface that limits the position, so the Offset is measured from the Center of the Pulley Grooves to the Bearing ID Edge on the Rear of the Pulley.

To obtain this value, take the measurement for A and B and subtract B from A.

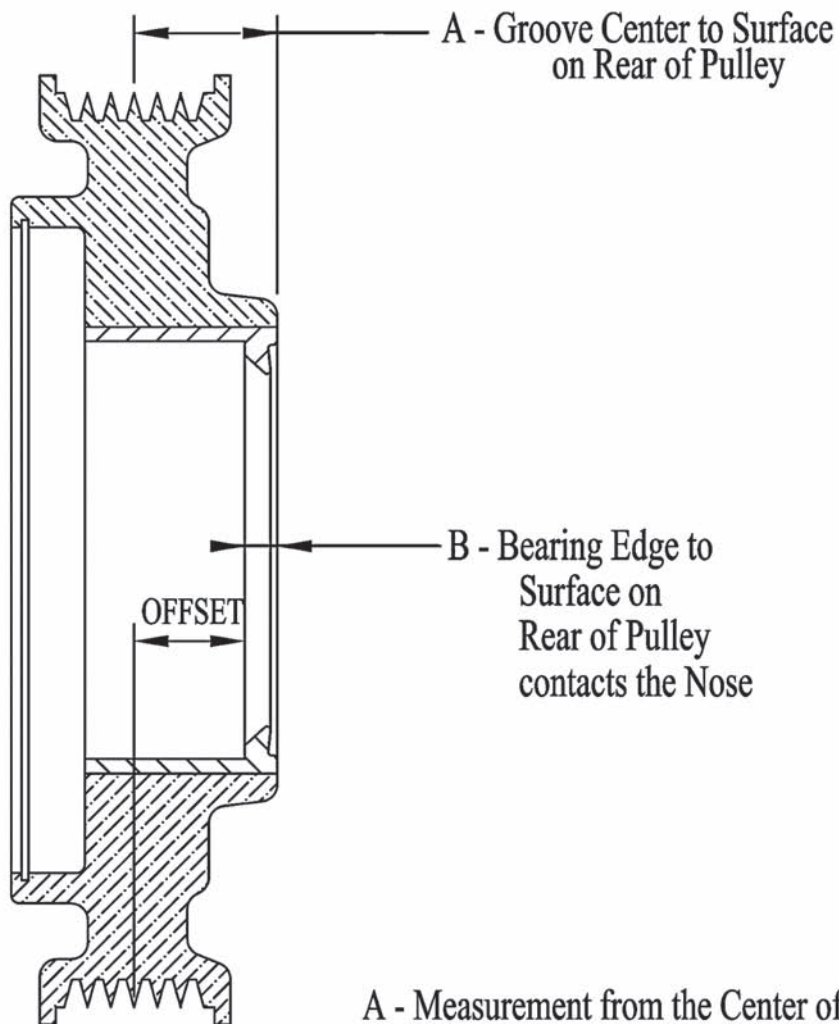

$$\text{OFFSET} = A - B$$

- A - Measurement from the Center of the Grooves to the Surface on the side where the Bearing contacts the Nose of the Compressor.
- B - Measurement from the edge of the Bearing to the same surface as in A above.



# Santech.

LIT-0221 CK 6/8/11  
2011© Santech Industries, Inc.

## Automotive & Mobile Air Conditioning Compressor Clutch Components Catalog



Registered  
to  
ISO9000:2008



World Class Excellence in Engineered Replacement Components



## Clutch Components

### A12-5113 Assorted Components

Rubber Bumper on Drive Hub Face



Rubber Bumper on Drive Hub Face

Ford FS10

### A13-5103 Assorted Components

Clutch Bearing Dust Shield Pad



GM/Harrison A6

### A13-5104 Assorted Components

Clutch Dust Cover



GM/Harrison A6

### A20-5103 Assorted Components

Nippondenso Clutch Driver Vibration Damper



### A45-5300 Assorted Components

Diesel Kiki / Zexel DKS / DKV Rubber Hub Bumper



### H20-7207 Assorted Components

Direct Drive Hub Rubber Dampeners - Generation III

Denso 6SEU12, 6SEU12C, 6SEU14C, 7SEU16, 7SEU17C

### H12-7901 Clutch Assembly

FX15 Clutch Assembly



Grooves: 8P  
Total OD: 131.6mm  
Thickness: 35.9mm

Ford FX15

### H12-7902 Clutch Assembly

FX15 Clutch Assembly



Grooves: 6P  
Total OD: 129.5mm  
Thickness: 31.0mm

Ford FS10, FX15

### H12-7904 Clutch Assembly

FS10 Clutch Assembly



Grooves: 6P  
Total OD: 113.0mm

Ford FS10

### H12-7905 Clutch Assembly

Ford FS10 Clutch Assembly (6 groove)

Grooves: 6P

Ford FS10

### H12-7906 Clutch Assembly

Ford FS10 Clutch Assembly (8 groove)

Grooves: 8P

Ford FS10

### H13-7900 Clutch Assembly

CVC Clutch Assembly



### H20-7901 Clutch Assembly

Denso 10S20H 05-07 3.3L V6  
Dodge Caravan Clutch Assembly



Grooves: 6P  
Total OD: 135.6mm  
Groove OD: 130.0mm  
Thickness: 39.0mm  
Offset: 21.4mm

Denso 10S20H

### H20-7954 Clutch Assembly

Composite Pulley Assembly for 7SEU17C

Composite Pulley Assembly for 7SEU17C

Denso 7SEU17C

### H20-7955 Clutch Assembly

Composite Pulley Assembly for 6SEU14C

Grooves: 4P  
Total OD: 114.0mm  
Groove OD: 110.0mm  
Thickness: 43.0mm

### H20-7961 Clutch Assembly

Metal Pulley Assembly for 6SEU12C / 6SEU14C



Grooves: 6P  
Total OD: 116.0mm  
Groove OD: 110.0mm  
Thickness: 43.0mm

Denso 6SEU12, 6SEU12C, 6SEU14C

### H20-7962 Clutch Assembly

Metal Pulley Assembly for 6SEU12C / 6SEU14C



Grooves: 6P  
Total OD: 116.0mm  
Groove OD: 110.0mm  
Thickness: 43.0mm

Denso 6SEU12, 6SEU12C, 6SEU14C

### H20-7963 Clutch Assembly

Metal Pulley Assembly for 6SEU12C / 6SEU14C



Grooves: 7P  
Total OD: 125.0mm  
Groove OD: 120.0mm  
Thickness: 46.0mm

Denso 6SEU12, 6SEU12C, 6SEU14C

### H20-7965 Clutch Assembly

Metal Pulley Assembly for 6SEU16C



Grooves: 8P  
Total OD: 118.0mm  
Groove OD: 110.0mm  
Thickness: 43.0mm

Denso 6SEU16

### H20-7966 Clutch Assembly

Metal Pulley Assembly for 7SEU16C / 7SEU17C



Grooves: 4P  
Total OD: 110.0mm  
Groove OD: 110.0mm  
Thickness: 35.0mm

Denso 7SEU16, 7SEU17C

### H20-7969 Clutch Assembly

Breakaway Torque Drive Assembly - Denso 7SEU17C (Audi)



Denso 7SEU17C

### H25-7900 Clutch Assembly

SD7H15 Clutch Assembly  
Dodge Ram

Sanden SD7H15

### H40-7901 Clutch Assembly

York 206 / 209 / 210 Clutch Assembly





Grooves: 2V  
Total OD: 152.5mm  
Thickness: 32.4mm

York 206, 209, 210

## Clutch Components

<p><b>H12-7301</b> Coil Clutch Coil Voltage: 12 Pigtail: E12-4000 <b>Ford</b> FS10</p>	<p><b>H12-7309</b> Coil Coil for HS18 Visteon Halla 09-06 Dodge 3500 Diesel Pickup  Voltage: 12 <b>Visteon</b> HS18</p>	<p><b>H13-7305</b> Coil Clutch Coil - 12 Volt - Rmfg  Voltage: 12 <b>GM/Harrison A6</b></p>
<p><b>H12-7302</b> Coil Clutch Coil  Voltage: 12 Pigtail: E12-4000 <b>Ford</b> FS10</p>	<p><b>H12-7310</b> Coil Coil for Ford Scroll 05-02 Explorer/05-03 Crown Victoria  Voltage: 12 Pigtail: E12-4000 <b>Ford</b> SCROLL</p>	<p><b>H13-7306</b> Coil Clutch Coil - 12 Volt  Voltage: 12 <b>GM/Harrison A6</b></p>
<p><b>H12-7303</b> Coil Visteon HS15/17/18 Coil with Hyundai Connector  Voltage: 12 <b>Ford</b> FS10 <b>Visteon</b> HS15, HS17, HS18</p>	<p><b>H12-7311</b> Coil Coil for Ford Scroll (European)  Voltage: 12 Pigtail: E12-4000 <b>Ford</b> SCROLL</p>	<p><b>H13-7310</b> Coil Delphi CVC coil  Voltage: 12</p>
<p><b>H12-7304</b> Coil Visteon HS15/17/18 Coil with Kia Connector  Voltage: 12 <b>Ford</b> FS10 <b>Visteon</b> HS15, HS17, HS18</p>	<p><b>H13-7300</b> Coil Clutch Coil w/Pin - High Amp  Voltage: 12 <b>GM/Harrison DA6, HD6, HR6, HR6HE, HU6, V5, V5 (DESTROKER), V7</b></p>	<p><b>H13-7312</b> Coil V5 Coil Voltage: 12 <b>GM/Harrison V5</b></p>
<p><b>H12-7306</b> Coil Clutch Coil - Large Style  Voltage: 12 Pigtail: E12-4000 <b>Ford</b> FS10</p>	<p><b>H13-7301</b> Coil Clutch Coil w/Pin (Gray)  Voltage: 12 <b>GM/Harrison HT6, R4</b></p>	<p><b>H13-7313</b> Coil V5 Coil - 24 volt  Voltage: 24 <b>GM/Harrison V5</b></p>
<p><b>H12-7307</b> Coil Clutch Coil  Voltage: 12 <b>Ford</b> FS10</p>	<p><b>H13-7302</b> Coil Clutch Coil - 24 Volt  Voltage: 24 <b>GM/Harrison A6</b></p>	<p><b>H13-7315</b> Coil V5 Coil Voltage: 12 <b>GM/Harrison V5</b></p>
<p><b>H12-7308</b> Coil Visteon VS18 Clutch Coil (w/o Thermal Fuse)  Voltage: 12 Pigtail: E12-4000</p>	<p><b>H13-7303</b> Coil GM V5 Coil  Voltage: 12 <b>GM/Harrison V5</b></p>	<p><b>H13-7318</b> Coil Delphi CVC 165 / 185 Coil  Voltage: 12 <b>Delphi</b> CVC-165, CVC-185</p>
<p><b>H12-7308E</b> Coil Visteon VS18 Clutch Coil (with Thermal Fuse) Voltage: 12 Pigtail: E12-4000 <b>Visteon</b> VS18</p>	<p><b>H13-7304</b> Coil Clutch Coil w/Spade - High Amp  Voltage: 12 <b>Daewoo</b> V5 <b>GM/Harrison DA6, HR6, HR6HE, HU6, V5, V5 (DESTROKER)</b></p>	<p><b>H13-7319</b> Coil Coil for V5 (Special-Blue) I.D 51.5mm 00-03 Daewoo Nubira  Voltage: 12 <b>GM/Harrison V5</b></p>

## Clutch Components

<p><b>H20-7300</b> <span style="float: right;">Coil</span></p> <p>Denso SC40/SCS06C/10S11 Coil Toyota, Echo, Yaris</p>  <p>Voltage: 12 OD: 87.0mm Coil ID: 59.6mm Thickness: 25.0mm Clocking: 6:00 Toyota / LexusSuzuki Aerio</p> <p><b>Denso</b> 10S11C, SCS06C</p>	<p><b>H20-7310</b> <span style="float: right;">Coil</span></p> <p>Denso 7PV16 Coil</p>  <p>Voltage: 12 OD: 96.6mm Coil ID: 61.6mm Thickness: 27.6mm</p>	<p><b>H20-7330</b> <span style="float: right;">Coil</span></p> <p>Nippondenso 10P08E Coil 90 Geo Metro 1.0L</p>  <p>Voltage: 12 OD: 87.0mm Coil ID: 62.0mm Nose ID: 39.0mm Thickness: 26.0mm Clocking: 5:30 Ground and Connector90 Geo Metro 1.0L</p> <p><b>Denso</b> 10P08E</p>
<p><b>H20-7301</b> <span style="float: right;">Coil</span></p> <p>Denso SC08/10S11 Coil 96-97 Tercell,Suzuki,G Vitara,Chevy Tr</p>  <p>Voltage: 12 OD: 96.4mm Coil ID: 61.0mm Nose ID: 40.0mm Thickness: 25.0mm Clocking: 6:30 97-96 TercellSuzuki Grand VitaraChevy Truck</p> <p><b>Denso</b> 10S11C, SC08C (USA)</p>	<p><b>H20-7315</b> <span style="float: right;">Coil</span></p> <p>Denso 7SBU16C Coil</p>  <p>Voltage: 12 OD: 96.6mm Coil ID: 61.6mm Thickness: 27.8mm Clocking: 6:00</p> <p><b>Denso</b> 10SR15C, 10SR17C, 7SBU16C</p>	<p><b>H20-7332</b> <span style="float: right;">Coil</span></p> <p>Coil - 12 Volt Voltage: 12</p> <p><b>Denso</b> 10S20H</p>
<p><b>H20-7302</b> <span style="float: right;">Coil</span></p> <p>Coil - 12 Volt Voltage: 12 OD: 80.0mm Coil ID: 55.0mm Nose ID: 40.0mm Thickness: 24.5mm Clocking: 6:30 Toyota Echo / Yaris</p> <p><b>Denso</b> 7SBU17C</p>	<p><b>H20-7320</b> <span style="float: right;">Coil</span></p> <p>Coil - 12 Volt</p>  <p>Voltage: 12 OD: 96.3mm Coil ID: 61.6mm Thickness: 27.5mm Ground and Connector</p> <p><b>Denso</b> 10PA15 Series, 10PA17 Series, 10PA20C, 10PA20H, 10PA20J, 10PA20SC, 10PA20SH, 10PA20VC</p>	<p><b>H25-7300</b> <span style="float: right;">Coil</span></p> <p>Sanden SD7V16 Coil</p>  <p>Voltage: 12 OD: 103.0mm Coil ID: 64.0mm Nose ID: 45.0mm Thickness: 28.0mm Clocking: 11:30 Fits 1215 / 1226 / 1233 / 1245</p> <p><b>Sanden</b> SD7V16</p>
<p><b>H20-7303</b> <span style="float: right;">Coil</span></p> <p>Denso 10S17 Coil 03-04 Honda Accord</p>  <p>Voltage: 12 OD: 96.4mm Coil ID: 61.0mm Nose ID: 40.0mm Thickness: 25.0mm Clocking: 6:30 Ground and Honda Connector04-03 Honda Accord</p> <p><b>Denso</b> 10S17C</p>	<p><b>H20-7321</b> <span style="float: right;">Coil</span></p> <p>Coil - 24 Volt</p>  <p>Voltage: 24 OD: 96.3mm Coil ID: 61.6mm Thickness: 27.5mm Clocking: 0.5 Ground and Connector</p> <p><b>Denso</b> 10PA15 Series, 10PA17 Series, 10PA20C, 10PA20H, 10PA20J, 10PA20SC, 10PA20SH, 10PA20VC</p>	<p><b>H25-7301</b> <span style="float: right;">Coil</span></p> <p>Sanden SD7V16 Coil</p>  <p>Voltage: 12 OD: 103.0mm Coil ID: 64.0mm Nose ID: 45.0mm Thickness: 27.3mm Clocking: 11:30 Fits 1100 / 1137 / 1162</p> <p><b>Sanden</b> SD7V16</p>
<p><b>H20-7304</b> <span style="float: right;">Coil</span></p> <p>Nippondenso 10S11 Coil Voltage: 12 OD: 86.9mm Coil ID: 59.6mm Nose ID: 40.0mm Thickness: 27.5mm</p> <p><b>Denso</b> 10S11C</p>	<p><b>H20-7325</b> <span style="float: right;">Coil</span></p> <p>Denso 10P15C Coil</p>  <p>Voltage: 12 OD: 107.0mm Coil ID: 71.0mm Thickness: 32.0mm Ground and Connector</p> <p><b>Denso</b> 10P15C</p>	<p><b>H25-7302</b> <span style="float: right;">Coil</span></p> <p>Sanden SD7V16 Coil</p>  <p>Voltage: 12 OD: 103.0mm Coil ID: 64.0mm Nose ID: 45.0mm Thickness: 33.0mm Clocking: 11:30 Fits 1206 / 1221 / 1231</p> <p><b>Sanden</b> SD7V16</p>

## Clutch Components

### H25-7303

Coil

Sanden SD7V16 Coil



Voltage: 12  
OD: 96.0mm  
Coil ID: 64.0mm  
Nose ID: 45.0mm  
Thickness: 32.5mm  
Clocking: 11:30  
Fits 1106 / 1172 / 1218 / 1227 / 1238

**Sanden** SD7V16

### H25-7334

Coil

Sanden TRS105 Coil



Voltage: 12  
OD: 86.3mm  
Coil ID: 59.0mm  
Nose ID: 45.0mm  
Thickness: 33.5mm  
Clocking: 10:00  
Fits 3211

**Sanden** TRS105

### H25-7357

Coil

Sanden SD7H15 Coil



Voltage: 12  
OD: 96.0mm  
Coil ID: 64.0mm  
Thickness: 32.0mm  
Clocking: 5:30

**Sanden** SD7H15

### H25-7304

Coil

Sanden SD7V16 Coil



Voltage: 12  
OD: 96.0mm  
Coil ID: 61.0mm  
Nose ID: 45.0mm  
Thickness: 28.0mm  
Clocking: 8:00

**Sanden** PXV16

### H25-7335

Coil

Sanden TR90 94-01 Honda Civic, (Except Mazda) Sanden 4993



Voltage: 12  
OD: 86.5mm  
Coil ID: 59.0mm  
Nose ID: 45.0mm  
Thickness: 33.5mm  
Clocking: 5:30  
Fits 99301-94 Honda Civic

**Sanden** TR90

### H25-7362

Coil

Sanden SD7H15 Coil



Voltage: 12  
OD: 96.0mm  
Coil ID: 64.0mm  
Thickness: 32.0mm

**Sanden** SD7H15

### H25-7310

Coil

Sanden SD6V12 Coil



Voltage: 12  
OD: 86.2mm  
Coil ID: 59.0mm  
Nose ID: 45.0mm  
Thickness: 31.0mm  
Clocking: 8:00

**Sanden** SD6V12

### H25-7340

Coil

Sanden SD7H15 24 Volt Coil



Voltage: 24  
OD: 96.0mm  
Coil ID: 64.0mm  
Thickness: 31.5mm  
Clocking: 5:30

**Sanden** SD7H15

### H25-7366

Coil

Sanden SD6V12 Coil



Voltage: 12  
OD: 86.0mm  
Coil ID: 59.0mm  
Thickness: 33.5mm

**Sanden** SD6V12

### H25-7311

Coil

Sanden SD6V12 Coil



Voltage: 12  
OD: 86.2mm  
Coil ID: 59.0mm  
Nose ID: 45.0mm  
Thickness: 34.5mm  
Clocking: 11:30  
Fits 1410

**Sanden** SD6V12

### H25-7353

Coil

Sanden SD709 Coil



Voltage: 12  
OD: 96.0mm  
Coil ID: 64.0mm  
Nose ID: 45.0mm  
Thickness: 31.5mm  
Clocking: 5:30

**Sanden** SD709

### H25-7368

Coil

Sanden SD507 Coil



Voltage: 12  
OD: 96.0mm  
Coil ID: 64.0mm  
Thickness: 31.2mm

**Sanden** SD507

### H25-7332

Coil

Sanden TRF105 Coil



Voltage: 12  
OD: 86.3mm  
Coil ID: 59.0mm  
Nose ID: 45.0mm  
Thickness: 32.0mm  
Clocking: 11:30  
01-97 Civic Gold / Saab

**Sanden** TRF105

### H25-7354

Coil

Sanden SD7B10 Coil



Voltage: 12  
OD: 86.2mm  
Coil ID: 59.0mm  
Thickness: 29.5mm  
Clocking: 5:30

**Sanden** SD7B10

### H25-7384

Coil

Coil for TRSA09 03-05 Honda Civic Hybrid 1.3 Elec/Gas



Voltage: 12  
OD: 81.5mm  
Coil ID: 58.0mm  
Thickness: 34.3mm

05-03 Honda Civic Hybrid 1.3L

**Sanden** TRSA09

### H25-7385

Coil

Coil for Sanden TR compressor

Voltage: 12  
OD: 96.0mm  
Coil ID: 64.0mm  
Thickness: 32.0mm  
Male/Female Bullet Connectors

## Clutch Components

<p><b>H25-7387</b> <span style="float: right;">Coil</span></p> <p>Sanden SD7H15 Coil</p>  <p>Voltage: 12 OD: 102.9mm Coil ID: 64.0mm Thickness: 27.3mm 02-94 Dodge Dakota / Ram 2500/3500</p> <p><b>Sanden</b> SD7H15</p>	<p><b>H30-7321</b> <span style="float: right;">Coil</span></p> <p>DKS13 Coil</p>  <p>Voltage: 12 OD: 122.0mm Coil ID: 66.0mm Nose ID: 40.0mm Thickness: 21.8mm Clocking: 6:00</p>	<p><b>H40-7304</b> <span style="float: right;">Coil</span></p> <p>York Coil - 24 Volt</p> <p>Voltage: 24 OD: 116.5mm Coil ID: 67.0mm Thickness: 39.5mm Clocking: 12:00 2 Bullet Connectors</p>
<p><b>H25-7388</b> <span style="float: right;">Coil</span></p> <p>Sanden PXV Coil</p>  <p>Voltage: 12 OD: 101.0mm Coil ID: 66.0mm Nose ID: 45.0mm Thickness: 27.5mm</p> <p><b>Sanden</b> PXV16</p>	<p><b>H35-7300</b> <span style="float: right;">Coil</span></p> <p>Coil Single Wire w/Diode 95.7x64x40x27.1</p> <p style="text-align: center;">No Photo</p> <p>Voltage: 12 OD: 95.7mm Coil ID: 64.0mm Nose ID: 40.0mm Thickness: 27.1mm Single Wire w/ Diode</p> <p><b>Seiko-Seiki</b> SS96D1, SS96D2</p>	<p><b>H40-7307</b> <span style="float: right;">Coil</span></p> <p>York AAEC-013 Coil</p> <p>Voltage: 12 OD: 86.0mm Coil ID: 59.0mm Thickness: 32.0mm Clocking: 11:00</p>
<p><b>H25-7389</b> <span style="float: right;">Coil</span></p> <p>Sanden TRSE07 Coil</p>  <p>Voltage: 12 OD: 86.2mm Coil ID: 59.0mm Nose ID: 45.0mm Thickness: 35.3mm 11-05 Honda Civic</p> <p><b>Sanden</b> TRSE07</p>	<p><b>H40-7300</b> <span style="float: right;">Coil</span></p> <p>York Coil</p>  <p>Voltage: 12 OD: 116.5mm Coil ID: 67.0mm Thickness: 39.5mm Bullet Connector</p>	<p><b>H40-7309</b> <span style="float: right;">Coil</span></p> <p>York Coil</p>  <p>Voltage: 12 OD: 116.5mm Coil ID: 67.0mm Thickness: 51.2mm Clocking: 12:00 Single Pin Connector</p>
<p><b>H30-7309</b> <span style="float: right;">Coil</span></p> <p>Diesel Kiki Coil</p>  <p>Voltage: 12 OD: 100.0mm Coil ID: 66.0mm Thickness: 28.0mm Clocking: 2:00</p>	<p><b>H40-7301</b> <span style="float: right;">Coil</span></p> <p>York Coil</p>  <p>Voltage: 12 OD: 116.5mm Coil ID: 67.0mm Thickness: 39.5mm Clocking: 12:00 Single Pin Connector</p>	<p><b>H50-7300</b> <span style="float: right;">Coil</span></p> <p>Coil for Matsushita / Panasonic</p> <p>Voltage: 12 OD: 111.6mm Coil ID: 66.0mm Nose ID: 42.0mm Thickness: 32.1mm</p>
<p><b>H30-7312</b> <span style="float: right;">Coil</span></p> <p>Diesel Kiki Coil</p>  <p>Voltage: 12 OD: 104.8mm Coil ID: 65.6mm Thickness: 28.0mm Clocking: 2:00</p> <p><b>Diesel Kiki</b> DKS17D</p>	<p><b>H40-7303</b> <span style="float: right;">Coil</span></p> <p>York Coil</p>  <p>Voltage: 12 OD: 116.5mm Coil ID: 67.0mm Thickness: 39.5mm 2 Pin Connector</p>	<p><b>H50-7303</b> <span style="float: right;">Coil</span></p> <p>Matsushita H12A1AH4DX Coil - 05-03 Civic Hybrid 1.3 Elec/Gas</p> <p>Voltage: 12 OD: 87.7mm Coil ID: 58.3mm Thickness: 33.5mm Clocking: 12:00 05-03 Civic Hybrid 1.3L</p> <p><b>Mats/Pan</b> H12A1AH4DX</p>
		<p><b>H50-7304</b> <span style="float: right;">Coil</span></p> <p>Matsushita H12A1AH4DX Coil</p>  <p>Voltage: 12 OD: 88.0mm Coil ID: 58.5mm Nose ID: 42.0mm Thickness: 32.3mm</p> <p><b>Mats/Pan</b> H12A1AH4DX</p>

## Clutch Components

### H80-7300

Coil

Tama TM16HD Coil For Universal Double V Belt



Voltage: 12

### H12-7000

Hub

Clutch Hub (21 Spline) (Shaft Length 23mm) (Leaf Spring)



OD: 122.0mm  
Offset: 2.7mm  
Shaft ID: 13.5mm  
Spline/Key: 21  
Post Depth: 18.7mm  
Post Height: 21.7mm

Ford FS10

### H12-7001

Hub

Clutch Hub (21 Spline) (Shaft Length 17mm) (Leaf Spring)



OD: 122.0mm  
Offset: 1.7mm  
Shaft ID: 13.5mm  
Spline/Key: 21  
Post Depth: 18.4mm  
Post Height: 17.0mm

Ford FS10

### H12-7002

Hub

FS10 Clutch Hub

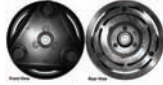

OD: 122.0mm  
Offset: 2.3mm  
Shaft ID: 13.5mm  
Spline/Key: 21  
Post Depth: 19.5mm  
Post Height: 21.0mm

Ford FS10

### H12-7004

Hub

Ford FS10 Hub



OD: 111.5mm  
Offset: 2.3mm  
Shaft ID: 13.5mm  
Spline/Key: 21

Ford FS10

### H12-7005

Hub

Clutch Hub (110mm dia.) (21 Spline) (Leaf Spring)



OD: 110.0mm  
Offset: 2.0mm  
Shaft ID: 13.5mm  
Spline/Key: 21  
Post Depth: 18.5mm  
Post Height: 20.9mm

Ford FS10

### H12-7006

Hub

Clutch Hub 2006 Jeep Liberty (115mm dia) Ford XF5H-19D7



OD: 115.0mm  
Offset: 2.5mm  
Shaft ID: 13.5mm  
Spline/Key: 21  
Post Depth: 18.4mm  
Post Height: 21.5mm  
2006 Jeep LibertyFord XF5H-19D7

Ford FS10

### H12-7007

Hub

Clutch Hub for Ford Scroll Compressors



OD: 107.0mm  
Offset: 4.5mm  
Shaft ID: 9.5mm  
Spline/Key: 18

Ford SCROLL

### H12-7008

Hub

Clutch Hub for HS090 / HS110 Hub (CRV / Civic / Accura)

OD: 102.3mm  
Offset: 6.5mm  
Shaft ID: 9.5mm  
Spline/Key: 18  
Post Depth: 10.5mm  
Post Height: 8.0mm  
CRV / Civic / Acura

Visteon HS090L, HS090R, HS110R

### H12-7011

Hub

Ford / Halla HS18 Clutch Hub



OD: 105.0mm  
Shaft ID: 13.5mm  
Spline/Key: 21

Visteon HS18

### H12-7012

Hub

Ford HS18 Clutch Hub 3-grommet 09-06 Fullsize Dodge Pick Up



OD: 115.0mm  
Offset: 20.1mm  
Shaft ID: 12.8mm  
Spline/Key: 21  
Post Depth: 18.9mm  
Post Height: 22.0mm  
3-Grommet09-06 Full Size Dodge Pickup

Visteon HS18

### H13-7000

Hub

Steel Clutch Hub



OD: 128.0mm  
Offset: 20.3mm  
Shaft ID: 13.7mm (16mm)  
Spline/Key: Key (4mm)

GM/Harrison DA6, HD6, HR6, HR6HE, HT6, HU6, R4

### H13-7001

Hub

Clutch Hub (Arrowhead Style)



OD: 128.0mm  
Offset: 20.3mm  
Shaft ID: 13.7mm (16mm)  
Spline/Key: Key (4mm)

Daewoo V5

GM/Harrison V5, V5 (DESTROKER), V7

### H13-7002

Hub

Clutch Hub



GM/Harrison A6

### H13-7003

Hub

A6 Short Shaft Clutch Hub (New)



GM/Harrison A6

### H13-7004

Hub

Clutch Hub



OD: 120.0mm  
Offset: 23.1mm  
Shaft ID: 13.7mm (16mm)  
Spline/Key: Key (4mm)

GM/Harrison A6

### H13-7005

Hub

A6 Long Shaft Clutch Hub (New)



OD: 120.0mm  
Offset: 21.0mm  
Shaft ID: 13.7mm (16mm)  
Spline/Key: Key (4mm)

GM/Harrison A6

### H13-7006

Hub

V5 Clutch Hub

OD: 112.0mm  
Offset: 25.3mm  
Shaft ID: 13.7mm (16mm)  
Spline/Key: Key (4mm)

GM/Harrison V5

## Clutch Components

### H13-7010

Hub

Hub



**Delphi** CVC-135E

### H13-7012

Hub

CVC 125 135 Small Drive Hub 105.5mm, 15.71 post Ht

OD: 105.5mm  
Offset: -2.3mm  
Shaft ID: 12.5mm  
Spline/Key: 23  
Post Height: 15.7mm

**Delphi** CVC-125, CVC-135, CVC6

### H13-7014

Hub

Hub for SP15/17 fits 06 Tacoma / 07 Ford Fusion 3.0L

06 Tacoma/07 Ford Fusion 3.0L

**Delphi** SP15, SP17

### H14-7003

Hub

Delphi CVC Hub - For Renault



OD: 110.0mm  
Renault

**Delphi** CVC-125, CVC6

### H20-7001

Hub

Hub - 92.5mm Diameter



OD: 92.5mm  
Offset: 16.1mm  
Spline/Key: Keyed  
Post Height: 17.1mm  
Thread: 10x1.25

**Denso** 10S11C, 10S11P, 10S13C, 10S13P, 10S15C, 10S15L, 10S17C, 10S20C, 10S20F

### H20-7002

Hub

Hub - 88mm Diameter



OD: 88.0mm  
Offset: 1.0mm  
Shaft ID: 13.5mm  
Spline/Key: 25  
Post Depth: 12.4mm  
Post Height: 13.4mm  
Thread: 8x1.25

**Denso** 10S11C, 10S11P, 10S13C, 10S13P, 10S15C, 10S15L, 10S17C, 10S20C, 10S20F

### H20-7003

Hub

6CA17 Denso Hub Mercedes 000230 1311 Denso 447100-2485

OD: 105.0mm  
Spline/Key: 25  
Post Depth: 18.0mm  
Post Height: 11.8mm  
Thread: 8x1.25  
Mercedes 000230 131 1 Fits Denso 447100-2485

### H20-7004

Hub

Drive Hub



OD: 105.0mm  
Spline/Key: 25  
Post Depth: 18.0mm  
Post Height: 22.3mm  
Thread: 7x1.0

**Denso** 10PA15 Series, 10PA17 Series, 10PA20C, 10PA20H, 10PA20J, 10PA20SC, 10PA20SH, 10PA20VC, 10S11C, 10S11P, 10S13C, 10S13P, 10S15L, 10S17C, 10S20C, 10S20F

### H20-7006

Hub

Drive Hub



OD: 102.0mm  
Offset: -1.2mm  
Shaft ID: 13.5mm  
Spline/Key: 25  
Thread: 8x1.25

**Denso** 10S20C

### H20-7331

Hub

Hub Denso SC08C 04-00 Toyota Echo 1.5



04-00 Toyota Echo 1.5L

**Denso** SC08C (USA)

### H25-7004

Hub

Hub for Sanden SD7V16

OD: 105.0mm  
Offset: 8.0mm  
Shaft ID: 11.5mm  
Spline/Key: 22

**Sanden** SD7V16

### H25-7005

Hub

Sanden SD7V16 105mm Keyed 12.93mm I.D. 8.05mm Post

OD: 105.0mm  
Offset: 7.8mm  
Shaft ID: 12.9mm  
Spline/Key: Keyed  
Post Height: 8.1mm

**Sanden** SD7V16

### H25-7006

Hub

Sanden SD7V16 105mm OD Spring Type Spline Dia 11.7 Post 14.1

OD: 105.0mm  
Shaft ID: 11.7mm  
Post Height: 14.1mm  
Spring Type

**Sanden** SD7V16

### H25-7007

Hub

Sanden SD7V16 Hub

OD: 105.0mm  
Offset: -3.9mm  
Post Height: 13.3mm

**Sanden** SD7V16

### H25-7026

Hub

Sanden SD7V16 Hub



OD: 105.0mm  
Offset: 14.0mm  
Shaft ID: 11.5mm  
Spline/Key: 22

**Sanden** SD7V16

### H25-7032

Hub

Sanden TR90 Hub



OD: 109.0mm  
Offset: 12.0mm  
Shaft ID: 9.5mm  
Spline/Key: 18  
Post Height: 12.0mm  
Chrysler

**Sanden** TR90

### H25-7035

Hub

Sanden TRS090/A09 Late Honda Civic/Chrys Sprg/typ/no key



OD: 105.0mm  
Offset: 6.8mm  
Shaft ID: 9.5mm  
Spline/Key: 18

Spring Type Late Honda Civic / Chrysler

**Sanden** TRS090, TRSA09

### H25-7038

Hub

TRS105 Saab/Honda with Key



OD: 105.0mm  
Spline/Key: 17 (Male Key)  
Post Height: 5.0mm  
Saab / Honda

**Sanden** TRS105

### H25-7050

Hub

Sanden SD6V12 Hub

OD: 105.0mm  
Shaft ID: 11.5mm  
Spline/Key: 22  
Post Height: 9.0mm



## Clutch Components

<p><b>Sanden</b> SD6V12</p> <p><b>H25-7060</b> <b>Hub</b></p> <p>SD7H15 Short Splined Hub Standard 105.5 mm dia 9.5 mm shft h</p> <p>OD: 105.5mm Spline/Key: 23 (Male Key) Post Height: 9.5mm</p>	<p><b>H30-7005</b> <b>Hub</b></p> <p>Diesel Kiki Hub</p> <p>OD: 109.5mm Offset: 25.2mm Shaft ID: 12.5mm Spline/Key: 23</p>	<p><b>H50-7003</b> <b>Hub</b></p> <p>Matsushita H12A1AH4DX Hub</p> <p>OD: 100.0mm Offset: 15.2mm Shaft ID: 12.5mm Spline/Key: 23 Post Height: 21.5mm</p>
<p><b>Sanden</b> SD7H15</p> <p><b>H25-7061</b> <b>Hub</b></p> <p>Sanden 7H15 Std Keyed Hub Dodge Dakota Kenworth 4691 4663</p> <p>OD: 105.0mm Spline/Key: Key Post Depth: 17.0mm Post Height: 12.9mm Dodge DakotaKenworth 4691 4663</p>	<p><b>H30-7006</b> <b>Hub</b></p> <p>Diesel Kiki Hub</p> <p>OD: 111.0mm Offset: -6.7mm Shaft ID: 13.5mm Spline/Key: 25</p>	<p><b>Mats/Pan</b> H12A1AH4DX</p> <p><b>H55-7000</b> <b>Hub</b></p> <p>Hub for Mitsubishi MSC90C 99-98 Mitsubishi Mirage 1.5</p> <p>99-98 Mitsubishi Mirage 1.5</p> <p><b>Mitsubishi</b> MSC90C</p>
<p><b>Sanden</b> SD7H15</p> <p><b>H25-7066</b> <b>Hub</b></p> <p>PXV16 Hub</p> <p>OD: 105.0mm</p>	<p><b>H30-7007</b> <b>Hub</b></p> <p>Diesel Kiki TMA2 Hub</p> <p>OD: 111.0mm Offset: 2.5mm Shaft ID: 13.5mm Spline/Key: 25</p>	<p><b>Calsonic</b> CWV618</p> <p><b>H75-7001</b> <b>Hub</b></p> <p>Calsonic CWV618 Large Hub</p>
<p><b>Sanden</b> PXV16</p> <p><b>H30-7000</b> <b>Hub</b></p> <p>Diesel Kiki Hub</p> <p>OD: 111.5mm Offset: 2.7mm Shaft ID: 13.5mm Spline/Key: 25</p>	<p><b>H30-7009</b> <b>Hub</b></p> <p>Diesel Kiki TMA2 Hub</p> <p>OD: 111.0mm Offset: 2.5mm Shaft ID: 13.5mm Spline/Key: 25</p>	<p><b>Calsonic</b> CWV618</p> <p><b>H75-7002</b> <b>Hub</b></p> <p>Calsonic CWV618 Small Hub Calsonic/Nihon Infiniti G35 2003</p> <p>03 Infiniti G35</p>
<p><b>H30-7003</b> <b>Hub</b></p> <p>Diesel Kiki DKS220 Hub</p> <p>OD: 111.5mm Offset: 6.5mm Shaft ID: 13.5mm Spline/Key: 25</p>	<p><b>H30-7011</b> <b>Hub</b></p> <p>Diesel Kiki Hub</p> <p>OD: 109.5mm Offset: 4.8mm Shaft ID: 13.5mm Spline/Key: 25</p>	<p><b>Calsonic</b> CWV618</p> <p><b>H20-7202</b> <b>Hub Component</b></p> <p>Direct Drive Hub Cover</p> <p>Companion Hub: H20-7205</p> <p><b>Denso</b> 6SEU12, 6SEU12C, 6SEU14C, 7SEU16</p>
<p><b>H30-7004</b> <b>Hub</b></p> <p>Hub Spline / Seltec TM16HD 8 Poly groove Universal</p> <p>OD: 111.5mm Offset: 2.5mm Shaft ID: 13.5mm Spline/Key: 25</p>	<p><b>H35-7000</b> <b>Hub</b></p> <p>Seiko Seiki SS121DN2 Hub/109.5mm/O.D./Splined 12.3mm 13mm Po</p> <p>OD: 109.5mm Post Depth: 12.3mm Post Height: 13.0mm</p> <p><b>Seiko-Seiki</b> SS121DN2</p>	<p><b>Calsonic</b> CWV618</p> <p><b>H20-7203</b> <b>Hub Component</b></p> <p>Direct Drive Hub</p> <p><b>Denso</b> 5SE09C, 6SEU12, 6SEU12C, 6SEU14C, 6SEU16, 7SEU16</p>
		<p><b>H20-7204</b> <b>Hub Component</b></p> <p>Direct Drive Hub Rubber Damper</p> <p><b>Denso</b> 5SE09C, 5SE12C, 6SEU12, 6SEU12C, 6SEU14C, 6SEU16, 7SEU16</p>
		<p><b>H20-7205</b> <b>Hub Component</b></p> <p>Direct Drive Hub</p> <p>Companion Hub: H20-7202</p> <p><b>Denso</b> 6SEU12, 6SEU12C, 6SEU14C, 7SEU16</p>

## Clutch Components

### H20-7206 Hub Component

Direct Drive Hub

**Denso** 6SEU12, 6SEU12C,  
6SEU14C, 7SEU16, 7SEU17C

### H20-7208 Hub Component

Metal Retaining Ring for  
Generation II Hubs



**Denso** 5SE09C, 6SEU12, 6SEU12C,  
6SEU14C, 6SEU16, 7SEU16

### H20-7209 Hub Component

5SER09C Direct Drive Hub  
Cover - Generation II

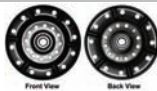

### H20-7210 Hub Component

5SER09C Direct Drive Hub -  
Generation II



### H20-7211 Hub Component

Denso 5SER09C Direct Drive  
Hub and Cover 05 Scion XB  
1.5



05 Scion XB 1.5

### H20-7220 Hub Component

Direct Drive Hub

- : 131.0mm
- : 12.0mm
- : 10x1.5

**Denso** 6SEU16

### A12-5118 Pulley

6 Groove Clutch Pulley  
w/Bearing

No Photo

**Ford** FS10

### A20-5106 Pulley

Clutch Pulley - 6 Groove



**Denso** 10PA20C

### H12-7700 Pulley

FORD FS10 Pulley 6 groove  
129 x 30.8



Grooves: 6P  
Total OD: 129.5mm  
Groove OD: 125.0mm  
Thickness: 30.8mm  
Offset: 7.6mm  
Bearing: B12-1120

**Ford** FS10

### H12-7703 Pulley

FORD FS10 Pulley 131.5 x  
36 8 groove



Grooves: 8P  
Total OD: 131.5mm  
Groove OD: 127.2mm  
Thickness: 36.8mm  
Offset: 10.7mm  
Bearing: B12-1120

**Ford** FS10

### H12-7709 Pulley

FORD FS10 Pulley 131.6 x 35.5 7 groove.

Grooves: 7P  
Total OD: 131.6mm  
Groove OD: 126.6mm  
Thickness: 35.5mm  
Offset: 9.8mm  
Bearing: B12-1120

**Ford** FS10

### H12-7714 Pulley

Ford FS10 Pulley 132.5mm x 43 mm 6 groove

Grooves: 6P  
Total OD: 132.5mm  
Groove OD: 128.5mm  
Thickness: 43.0mm  
Offset: 28.5mm  
Bearing: B12-1120

**Ford** FS10

### H12-7717 Pulley

Ford FS10 Pulley

Grooves: 4P  
Total OD: 128.0mm  
Groove OD: 124.0mm  
Thickness: 32.7mm  
Offset: 31.3mm  
Bearing: B12-1120

**Ford** FS10

### H12-7730 Pulley

Clutch Pulley 8 Groove  
w/Bearing



**Visteon** HS18

### H13-7700 Pulley

Clutch Pulley 6 Groove  
w/Bearing - 4.25"



Grooves: 6P  
Total OD: 108.0mm

**GM/Harrison** DA6, HD6, HR6, HR6HE,  
HT6, HU6

### H13-7706 Pulley

Pulley



Grooves: 1V  
Total OD: 143.3mm  
w/ Bearing

**GM/Harrison** A6

### H13-7707 Pulley

GM A6 2Gv Rolls Bentley  
Buick Cadillac Pulley with  
Bearing



Grooves: 2V  
Total OD: 143.3mm  
w/ Bearing

**GM/Harrison** A6

### H13-7710 Pulley

Harrison V5 Pulley - 6  
Groove (without bearing)



Grooves: 6P  
Total OD: 129.5mm  
Groove OD: 125.5mm  
Offset: 26.7mm  
Bearing: B13-1110

**GM/Harrison** V5

### H20-7706 Pulley

Clutch Pulley - 6 groove



Grooves: 2V  
Total OD: 152.0mm  
Thickness: 38.4mm

**Denso** 10S11C

### H20-7708 Pulley

Clutch Pulley - 6 groove



Total OD: 146.0mm  
Thickness: 30.5mm



**Denso** 10S11C

### H20-7717 Pulley

Denso 10S Pulley

Grooves: 7P  
Total OD: 132.0mm  
Groove OD: 120.0mm  
Thickness: 33.0mm  
Offset: 13.1mm  
Bearing: B20-1106

## Clutch Components

<p><b>H20-7722</b> Pulley</p> <p>Denso 10PA17C and 10S20H Pulley</p> <p>Grooves: 6P Total OD: 135.6mm Groove OD: 130.0mm Thickness: 39.0mm Offset: 21.4mm Bearing: B20-1106</p> <p><b>Denso</b> 10PA17C, 10S20H</p>	<p><b>H20-7859</b> Pulley</p> <p>Denso 7SEU16C / 7SEU17C Direct Drive Pulley - Metal</p> <p>Grooves: 6P Total OD: 130.0mm Groove OD: 126.0mm</p> <p><b>Denso</b> 7SEU16, 7SEU17C</p>	<p><b>H25-7705</b> Pulley</p> <p>SD7H15 Pulley 7 groove Dodge Dakota and Durango 5.2 and 5</p>  <p>Grooves: 7P Total OD: 133.0mm Groove OD: 130.0mm Offset: 16.3mm Bearing: B10-1107</p> <p><b>Sanden</b> SD7H15</p>
<p><b>H20-7750</b> Pulley</p> <p>Pulley 10PA17C 123.8 mm O.D. 30.59 Tk.</p>  <p>Grooves: 1V Total OD: 123.8mm Thickness: 30.6mm</p> <p><b>Denso</b> 10PA17C</p>	<p><b>H20-7860</b> Pulley</p> <p>Denso 6SEU12C / 6SEU14C Direct Drive Pulley - Metal</p> <p>Grooves: 6P Total OD: 105.0mm Groove OD: 100.0mm</p> <p><b>Denso</b> 6SEU12, 6SEU12C, 6SEU14C</p>	<p><b>H25-7706</b> Pulley</p> <p>Pulley Sanden SD7V16 6 Poly 126.8 O.D. 34 mm tk</p> <p>Grooves: 6P Total OD: 127.0mm Groove OD: 127.0mm Thickness: 34.0mm Offset: 16.5mm Bearing: B10-1107</p> <p><b>Sanden</b> SD7V16</p>
<p><b>H20-7809</b> Pulley</p> <p>Denso 7SEU16C Composite Pulley</p> <p><b>Denso</b> 7SEU17C</p>	<p><b>H20-7866</b> Pulley</p> <p>Denso 7SEU17C Direct Drive Pulley - Metal</p> <p>Grooves: 6P Total OD: 105.0mm Groove OD: 100.0mm</p> <p><b>Denso</b> 7SEU17C</p>	<p><b>H25-7708</b> Pulley</p> <p>Pulley Sanden SD7V16 8 Poly 123.0 O.D. 35 mm tk</p> 
<p><b>H20-7816</b> Pulley</p> <p>Denso 7SEU17C Composite Pulley</p>  <p>Grooves: 6P Total OD: 110.0mm Thickness: 35.3mm</p> <p><b>Denso</b> 7SEU17C</p>	<p><b>H20-7867</b> Pulley</p> <p>Denso 7SEU17C Direct Drive Pulley - Metal</p> <p>Grooves: 6P Total OD: 115.0mm Groove OD: 110.0mm</p> <p><b>Denso</b> 7SEU17C</p>	<p>Grooves: 8P Total OD: 123.0mm Groove OD: 119.0mm Offset: 13.5mm Bearing: B10-1107</p> <p><b>Sanden</b> SD7V16</p>
<p><b>H20-7840</b> Pulley</p> <p>Denso 7SEU16C Metal Pulley</p> <p>Grooves: 4P Total OD: 114.0mm Groove OD: 110.0mm Thickness: 43.0mm</p> <p><b>Denso</b> 7SEU16</p>	<p><b>H20-7870</b> Pulley</p> <p>Denso 6SEU14C Direct Drive Pulley - Metal</p> <p>Grooves: 6P Total OD: 120.0mm Groove OD: 115.0mm</p> <p><b>Denso</b> 6SEU14C</p>	<p><b>H25-7734</b> Pulley</p> <p>Pulley Sanden SD508S</p> <p>Grooves: 2V Total OD: 132.0mm Groove OD: 132.0mm Offset: 24.3mm Bearing: B95-1101</p> <p><b>Sanden</b> SD508</p>
<p><b>H20-7841</b> Pulley</p> <p>Denso 6SEU12C / 6SEU14C Metal Pulley</p> <p>Grooves: 6P Total OD: 114.0mm Groove OD: 110.0mm Thickness: 30.0mm</p> <p><b>Denso</b> 6SEU12, 6SEU12C, 6SEU14C</p>	<p><b>H20-7871</b> Pulley</p> <p>Denso 7SEU16C Direct Drive Pulley - Metal</p> <p>Grooves: 4P Total OD: 100.0mm Groove OD: 100.0mm</p> <p><b>Denso</b> 7SEU16</p>	<p><b>H75-7700</b> Pulley</p> <p>Calsonic CWV618 Pulley - Large Bearing - 5 groove</p>  <p>Grooves: 5P</p> <p><b>Calsonic</b> CWV618</p>
<p><b>H20-7846</b> Pulley</p> <p>Denso 7SEU16C / 7SEU17C Metal Pulley</p> <p>Grooves: 4P Total OD: 110.0mm Groove OD: 100.0mm Thickness: 35.0mm</p> <p><b>Denso</b> 7SEU16, 7SEU17C</p>	<p><b>H20-7950</b> Pulley</p> <p>Denso 6SEU12C &amp; 7SEU16C Splined Drive Shaft</p>  <p><b>Denso</b> 6SEU12, 6SEU12C, 6SEU14C, 7SEU16</p>	<p><b>H75-7701</b> Pulley</p> <p>Calsonic CWV618 Pulley - Large Bearing - 5 groove</p>  <p>Grooves: 6P</p> <p><b>Calsonic</b> CWV618</p>
<p><b>H20-7850</b> Pulley</p> <p>Denso 5SE12C Direct Drive Pulley - Metal</p> <p>Grooves: 6P Total OD: 105.0mm Groove OD: 100.0mm</p> <p><b>Denso</b> 5SE12C</p>	<p><b>H25-7702</b> Pulley</p> <p>Sanden SD7V16 Pulley</p>  <p>Grooves: 6P Total OD: 119.0mm Groove OD: 119.0mm Offset: 24.5mm Bearing: B10-1107</p> <p><b>Sanden</b> SD7V16</p>	<p><b>K20-5000</b></p> <p>Generation II Direct Drive Hub Repair Kit</p> <p>Includes: H20-7203 (1), H20-7204 (6), H20-7208 (1).</p>

## Control Valves

### E20-7060 Electronic

Control Valve (Straight Terminal)



Denso 5SE09C, 5SE12C

### E20-7061 Electronic

Control Valve (90° Terminal)

Denso 5SE09C, 5SE12C, 7SBU17C

### E20-7064 Electronic

Control Valve (90° Terminal)



Denso 6SEU12, 6SEU12C, 6SEU14C, 6SEU16, 7SEU16, 7SEU17C

### E20-7065 Electronic

Control Valve (90° Terminal with Diode)



Denso 6SEU12, 6SEU16, 7SEU16

### E20-7070 Electronic

Control Valve (90° Terminal)



Denso 6SEU12, 6SEU16, 7SEU16, 7SEU17C

### E20-7074 Electronic

Control Valve



Denso 6SEU16

### E70-7000 Electronic

Control Valve



Zexel DCS17, DCS17E

### E75-7000 Electronic

Control Valve



### A12-5100 Mechanical

Control Valve for Ford Scroll



Ford LARGE SCROLL

### A12-5101 Mechanical

Mechanical Control Valve



Visteon VS12M, VS16, VS18M

### A13-5121 Mechanical

R12 Control Valve (Requires A13-5132)



Calsonic CWV615, CWV617, CWV618, V5-15C, V5-15F, V5-15G

### GM/Harrison V5, V5 (DESTROKER)

#### A13-5126 Mechanical

R134a Control Valve (Requires A13-5132)



Calsonic CWV615, CWV617, CWV618, V5-15C, V5-15F, V5-15G

Daewoo V5

Delphi CVC-125, CVC-135, CVC-165, CVC-185, CVC6, CVC7P

GM/Harrison V5, V5 (DESTROKER), V7

#### A13-5227 Mechanical

R134a Control Valve



GM/Harrison V5

#### A13-5228 Mechanical

R134a Control Valve



Delphi CVC-165, CVC-185, CVC7P

#### A13-5230 Mechanical

R134a Control Valve

GM/Harrison V5

#### A20-5063 Mechanical

Control Valve



Denso 7SBU16C

#### A20-5070 Mechanical

Main Control Valve



Denso 6SEU16  
Zexel DCS17C

#### A20-5071 Mechanical

Main Control Valve



Denso 5SL12CJ, 5SL142, 7SBU16C  
Zexel DCS17C

#### A20-5072 Mechanical

Control Valve



Chrysler 6C17  
Denso 6CA17C, 7SB16C

#### A25-5002 Mechanical

Control Valve



Sanden PXV16, SD7V16

### A25-5003 Mechanical

R134a Control Valve



Sanden SD6V12

### A25-5004 Mechanical

Control Valve



Sanden SD7V16

### A75-5100 Mechanical

Calsonic Control Valve (3 O-Rings)



Calsonic CSV613

### A13-5132 Mechanical Screen

Control Valve Screen



Calsonic CSV613, CWV615, CWV617, CWV618, V5-15C, V5-15F, V5-15G

Daewoo V5

Delphi CVC-125, CVC-135, CVC-165, CVC-185, CVC6, CVC7P

GM/Harrison V5, V5 (DESTROKER), V7

### A20-5121 Mechanical Screen

Control Valve Filter



Denso 5SL12CJ, 6CA17C, 7SB16C, 7SBU16C

### E20-4010 Pigtail

Pigtail



Denso 5SE09C, 5SE12C, 6SEU12, 6SEU12C, 6SEU14C, 6SEU16, 7SBU17C, 7SEU16, 7SEU17C

### K20-2174 Electronic

Control Valve Kit



Replaces:  
E20-7001, E20-7002, E20-7003, E20-7004, E20-7005, E20-7006, E20-7007, E20-7008, E20-7009, E20-7018, E20-7019

Denso 6SEU12, 6SEU12C, 6SEU14C, 6SEU16, 7SEU16, 7SEU17C

## Control Valves

### K20-2175 Electronic

Control Valve Kit



Replaces:  
E20-7010, E20-7011, E20-7012, E20-7013, E20-7015, E20-7017

**Denso** 5SE09C, 5SE12C, 7SBU17C

### K20-2047 Black Nitrile

Denso 10PA17VL Control Valve & Switch O-Ring Kit



Includes: Bottom/Side Switch O-Ring (1), Control Valve Mount/PRV O-Ring (3), Control Valve Plunger O-Ring (Small) (1), Control Valve Plunger O-Ring (Large) (1), Control Valve Plunger Top O-Ring (1), Rear Plunger O-Ring (1).

**Denso** 10PA15VL, 10PA17VC, 10PA17VL, 10PA17VSC

### K12-2151 Green HNBR

Visteon VS16 Control Valve O-Ring Kit



**Visteon** VS12M, VS16, VS18M

### K13-2122 Green HNBR

GM V5 Control Valve O-Ring Kit



Includes: Control Valve O-Ring (Inside) (1), Control Valve O-Ring (Inside Center) (1), Control Valve O-Ring (Outside) (1), Control Valve O-Ring (Outside Center) (1)

**Calsonic** CSV613, CWV615, CWV617, CWV618, V5-15C, V5-15F, V5-15G

**Daewoo** V5

**Delphi** CVC-125, CVC-135, CVC-165, CVC-185, CVC6, CVC7P

**GM/Harrison** V5, V5 (DESTROKER), V7, V7 (DESTROKER)

### K13-2134 Green HNBR

Delphi CVC135E Control Valve O-Ring Kit



**Delphi** CVC-135E

### K20-2165 Green HNBR

Denso 5SE09C / 5SE12C Control Valve O-Ring Kit



**Denso** 5SE09C, 5SE12C, 7SBU17C

### K20-2166 Green HNBR

O-Ring Kit for 4 O-Ring Control Valves



Includes: Gaskets: Control Valve O-Rings (4).

**Denso** 6SEU12, 6SEU12C, 6SEU14C, 6SEU16, 7SEU16, 7SEU17C

### K20-2176 Green HNBR

Denso 5SL12CJ Control Valve O-Ring Kit



**Denso** 5SL12CJ

**Zexel** DCS17C

### K20-2178 Green HNBR

Denso 6CA17 Control Valve O-Ring Kit



Includes: Control Valve O-Ring (Inside) (1), Control Valve O-Ring (Outside) (1), Control Valve Seat O-Ring (1),

**Chrysler** 6C17

**Denso** 6CA17C

### K20-2180 Green HNBR

Denso 6SEU16C Control Valve Kit (7 O-Ring Valve)

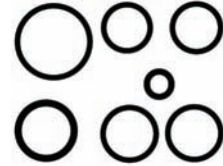

Includes all 7 o-rings needed to reseal the shaft of the control valve. For both straight and 90 degree connection valves (E20-7021 and E20-7022)

**Denso** 6SEU16

### K25-2144 Green HNBR

Sanden PXE13 / PXE16 / SD7C16 Control Valve O-Ring Kit



**Sanden** PXE13, PXE16, SD7C16

### K70-2102 Green HNBR

Zexel DCS17E Control Valve O-Ring Kit



**Zexel** DCS17E

## Electrical

<b>E11-4000</b> Pigtail	<b>E13-4003</b> Pigtail	<b>E13-1011</b> Switch
2-Wire Male Spade Pigtail	GM High Pressure Switch Connector	Condenser Fan Pressure Switch (Purple)
		
<b>Chrysler</b> A590, C171 <b>Denso</b> 10PA15VC, 10PA17VC, 10PA17VSC <b>Sanden</b> SD708, SD709	<b>Delphi</b> SP10 <b>GM/Harrison</b> A6, DA6, HD6, HR6, HR6HE, HT6, R4, V5, V5 (DESTROKER), V7	<b>Delphi</b> SP10 <b>GM/Harrison</b> A6, DA6, HD6, HR6, HR6HE, HT6, HU6, R4, V5, V5 (DESTROKER), V7
<b>E11-4004</b> Pigtail	<b>E20-4000</b> Pigtail	<b>E13-1012</b> Switch
2-Pin w/ Diode	BMW Clutch Coil Connector - 3 Pin	Hi Side Low Pressure Cut-Off Switch (Brown)
		
<b>Denso</b> 10PA15A, 10PA15C, 10PA15E, 10PA15L, 10PA15LC, 10PA15SC, 10PA17A, 10PA17C, 10PA17E, 10PA17H, 10PA17J, 10PA17K, 10PA17SC, 10PA17SH, 10S11C, 10S11P, 10S13C, 10S13P, 10S15C, 10S15L, 10S17C, 10S20C, 10S20F	<b>Denso</b> 10PA17C	<b>Delphi</b> SP10 <b>GM/Harrison</b> A6, DA6, HD6, HR6, HR6HE, HT6, HU6, R4, V5, V5 (DESTROKER), V7
<b>E11-4006</b> Pigtail	<b>E20-4003</b> Pigtail	<b>E13-1016</b> Switch
Single Pin Connector	Wire Harness for Chrysler Applications	Radiator Fan Pressure Switch Kit
		
<b>Denso</b> 10PA15A, 10PA15C, 10PA15E, 10PA15L, 10PA15LC, 10PA15SC, 10PA17A, 10PA17C, 10PA17E, 10PA17H, 10PA17J, 10PA17K, 10PA17SC, 10PA17SH	<b>Denso</b> 10S11C, 10S11P, 10S13C, 10S13P, 10S15C, 10S15L, 10S17C, 10S20C, 10S20F	<b>Delphi</b> SP10 <b>GM/Harrison</b> A6, DA6, HD6, HR6, HR6HE, HT6, HU6, R4, V5, V5 (DESTROKER), V7
<b>E12-4000</b> Pigtail	<b>E20-4004</b> Pigtail	<b>E13-1017</b> Switch
Clutch Coil Pigtail	Wire Harness for GM Applications	Radiator Fan Pressure Switch (Gray)
		
<b>Denso</b> 10P13 Series, 10P15 Series, 6E171, 6E171A, 6P134, 6P148, 6P148A, 6P148C	<b>Denso</b> 10S11C, 10S11P, 10S13C, 10S13P, 10S15C, 10S15L, 10S17C, 10S20C, 10S20F	<b>Delphi</b> SP10 <b>GM/Harrison</b> A6, DA6, HD6, HR6, HR6HE, HT6, HU6, R4, V5, V5 (DESTROKER), V7
<b>Ford</b> FS10, FS6, FS6 CROSS MOUNT, FX15	<b>E25-4001</b> Pigtail	<b>E13-1018</b> Switch
<b>E13-4000</b> Pigtail	Pigtail - Ford/Sanden Clutch Coils	Hi Side Low Pressure Cut-Off Switch (Black)
12" Flat Male Spade Pigtail, with Diode		
<b>GM/Harrison</b> A6, DA6, HD6, HR6, HR6HE, HT6, HU6, R4, V5, V5 (DESTROKER)	<b>E25-4002</b> Pigtail	<b>Delphi</b> SP10 <b>GM/Harrison</b> A6, DA6, HD6, HR6, HR6HE, HT6, HU6, R4, V5, V5 (DESTROKER), V7
<b>E13-4001</b> Pigtail	Pigtail - PSA Wire Leads	<b>E13-1019</b> Switch
Male 8mm Pin Type Pigtail, with Diode	<b>E95-4018</b> Pigtail	Low Pressure Cut-Off Switch Kit
	Pigtail - Nissan/Nihon Clutch Coli	
<b>GM/Harrison</b> DA6, HD6, HR6, HR6HE, HT6, HU6, R4, V5, V5 (DESTROKER)	<b>E95-4020</b> Pigtail	<b>Delphi</b> SP10 <b>GM/Harrison</b> A6, DA6, HD6, HR6, HR6HE, HT6, HU6, R4, V5, V5 (DESTROKER), V7
<b>E13-4002</b> Pigtail	Pigtail - Denso 5SE / TV12C Control Valve Connector	<b>E13-1022</b> Switch
GM Low Pressure Switch Connector		High Pressure Cut-Off Switch Kit
	<b>Denso</b> 5SE09C, 5SE12C, TV12C(R134)	
<b>Delphi</b> SP10 <b>GM/Harrison</b> A6, DA6, HD6, HR6, HR6HE, HT6, R4, V5, V5 (DESTROKER), V7	<b>E13-1009</b> Switch	<b>Delphi</b> SP10 <b>GM/Harrison</b> A6, DA6, HD6, HR6, HR6HE, HT6, HU6, R4, V5, V5 (DESTROKER), V7
<b>E13-4002</b> Pigtail	High Pressure Cut-Off Switch (Lt Blue)	
		
	<b>Delphi</b> SP10 <b>GM/Harrison</b> A6, DA6, HD6, HR6, HR6HE, HT6, HU6, R4, V5, V5 (DESTROKER), V7	

## Electrical

### **E13-1032** **Switch**

Denso High Pressure Switch  
Connector (Red Oval)



**Denso** 10S17C, 10S20C, 10S20F,  
10S20H

### **E20-1040** **Switch**

High Pressure Cut-Off Switch  
(Green Oval)



**Denso** 10S15C, 10S15L

### **E96-5167** **Switch**

High Pressure Cut-Off Switch  
(Red Oval)



**Denso** 10S17C, 10S20C, 10S20F,  
10S20H

### **E10-3000** **Wiring Assembly**

Male Bullet to Female Bullet,  
Diode Assembly



**Diesel Kiki** DKS15BH, DKS15CH,  
DKS17CH

**Sanden** SD708, SD709

**Tecumseh** HG1000, HG850

**York** SC206, SC209

### **E13-3000** **Wiring Assembly**

Flat Spade Type Extender  
Assembly



**GM/Harrison** A6, DA6, HD6, HR6, HR6HE,  
HT6, R4, V5, V5 (DESTROKER)

### **E13-3001** **Wiring Assembly**

Male Flat Spade to Female  
8mm Pin Assembly



**GM/Harrison** A6, DA6, HD6, HR6, HR6HE,  
HT6, R4, V5, V5 (DESTROKER)

### **E13-3002** **Wiring Assembly**

Male 8mm Pin to Female Flat  
Spade Assembly



**GM/Harrison** DA6, HD6, HR6, HR6HE,  
HT6, HU6, R4, V5, V5 (DESTROKER)

## Fasteners

### F95-8000

#### Adapter

Adapter



*Adapter - Oil Plug Switch Port*

**Behr** WINGCELL

### F11-2100

#### Bolt/Screw

Shipping Plate/Oil Plug Bolt



*Bolt - Shipping Closure (Use with C12-5101)*

**Ford** FS6, FS6 CROSS MOUNT

*Bolt - Shipping Plate*

**Calsonic** CR14, CWV615, CWV617, CWV618, DKV14D, V5-15C, V5-15F, V5-15G

**Chrysler** 6C17, A590, C171

**Delphi** SP10, SP15

**Denso** 10P08E, 10P13 Series, 10P15 Series, 10P17 Series, 10PA15A, 10PA15C, 10PA15E, 10PA15L, 10PA15LC, 10PA15SC, 10PA15VC, 10PA17A, 10PA17C, 10PA17E, 10PA17H, 10PA17J, 10PA17K, 10PA17SC, 10PA17SH, 10PA17VC, 10PA17VSC, 10PA20C, 10PA20H, 10P

**Diesel Kiki** DCV11A, DCV14A, DCV14J, DKS16H(R12), DKS16H(R134A), DKV11A, DKV11G, DKV14G, DKV14J

**Hitachi** A5000, MJ110, MJ167, MJS130, MJS170, SWP167

**Keihin** 150L

**Mats/Pan** N1300AC4, N1301AB4, N1301AD4, N1301AE4, N1300AA4, N1300AB4, N1300AE4, SA1150AE4

**Mitsubishi** AX105VSR, FX105V, FX80, FXA105VS, FXA105VSLR, FXA105VSR, FXA105VSSS, MSC105CVS, MSC90, MSC90C

**Nihon** NVR140S

**Sanden** PXV16, SD5H09, SD709CA, SD709CP, SD7H15, SD7V16, TR090, TRF090, TRS090

**Seiko-Seiki** SS121DN1, SS121DN2, SS121DV2, SS96D1, SS96D2

**Visteon** HS15, HS17, HS18

*Bolt - Shipping Plate (9755 Model)*

**Sanden** TR70

*Bolt - Shipping Plate (Use w/ C12-4105)*

**Ford** FS10, FX15

*Bolt - Shipping Plate/Oil Drain Plug*

**Calsonic** CSV613

**Delphi** CVC-125, CVC-135, CVC-135E, CVC6

### F11-2103

#### Bolt/Screw

Shipping Plate Bolt



*Bolt - Shipping Plate*

**Chrysler** RV2

### F12-2105

#### Bolt/Screw

Shipping Plate Bolt (Use w/ C12-5102)



*Bolt - Shipping Plate*

**Visteon** VS16

### F12-2106

#### Bolt/Screw

Oil Fill Bolt



### F12-2108

#### Bolt/Screw

Shipping Plate Bolt (Use w/ C12-5102)



*Bolt - Rear Scroll / Shipping Plate (Use w/ C12-5102)*

**Ford** LARGE SCROLL, SCROLL

*Bolt - Shipping Plate*

**Sanden** PXE13, PXE16

*Bolt - Shipping Plate (Use w/ C12-5102)*

**Ford** FS10, FX15

### F13-2100

#### Bolt/Screw

Oil Plug Bolt



*Bolt - Oil Plug*

**York** 206, 209, 210, SC206, SC209

*Bolt - Shipping Plate*

**GM/Harrison** A6, R4

### F13-2102

#### Bolt/Screw

Clutch Dust Cover Screw



*Screw - Clutch Dust Cover*

**GM/Harrison** A6

### F13-2111

#### Bolt/Screw

Adapter Block Bolt



*Bolt - Adapter Block*

**GM/Harrison** DA6, HD6, HR6, HR6HE, HT6, HU6, R4, V5, V5 (DESTROKER)

### F13-2152

#### Bolt/Screw

Mounting Bolt (65mm)



*Bolt - Mounting (65mm)*

**GM/Harrison** R4

### F13-2153

#### Bolt/Screw

Shipping Plate Bolt (For C13-4100)



*Bolt - Shipping Plate*

**Diesel Kiki** DKS17G (DUAL), DKS17G (SINGLE)

*Bolt - Shipping Plate (For C13-4100)*

**GM/Harrison** DA6, HD6, HR6, HR6HE, HT6, R4, V5, V5 (DESTROKER)

### F20-2110

#### Bolt/Screw

Shipping Plate / Shaft Bolt

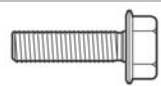

*Bolt - Front Head*

**Mitsubishi** MSC105CVS, MSC130CVSG, MSC130CVSG2, MSC90, MSC90C

**Sanden** SD6V12

*Bolt - Front Head / Shipping Plate*

**Visteon** HS090L, HS090R, HS110R

*Bolt - Head*

**Sanden** SD7C16

*Bolt - Head/Shipping*

**Sanden** TRSA09, TRSA12, TRSE07

*Bolt - Shaft*

**Calsonic** CR14, CSV613, DKV14D

**Delphi** CVC-125, CVC-135, CVC-135E, CVC-165, CVC-185, CVC6, CVC7P, SP10, SP15

**Denso** 10PA15 Series, 10PA17 Series, 10PA20C, 10PA20H, 10PA20J, 10PA20SC, 10PA20SH, 10PA20VC, 10S11C, 10S11P, 10S13C, 10S13P, 10S15C, 10S15L, 10S17C, 10S20C, 10S20F, 10S20H, 10SR15C, 10SR17C, 6CA17C, 6SEU12C, 6SEU14C, 6SEU16, SC08 (ITALY), SC

**Diesel Kiki** DCV11A, DCV14A, DCV14J, DCW17B, DCW17D, DKS13G (DUAL), DKS13G (SINGLE), DKS13S, DKS15BH, DKS15CH, DKS15G, DKS15S, DKS17CH, DKS17D, DKS17G (DUAL), DKS17G (SINGLE), DKS17S, DKV11A, DKV14J

**Ford** FS10, FS18, FX15

**Mats/Pan** N1301AB4, N1301AD4, N1301AE4, S1150F3, S1150X3, SA1150AE4

**Nihon** DKV14C

**Seiko-Seiki** SS10LV6, SS10V1, SS10V6, SS96D1, SS96D2



## Fasteners

### Bolt - Shaft

**Visteon** HS15, HS17, HS18, VS12M, VS16, VS18M

### Bolt - Shipping Plate

**Denso** 5SE09C, 5SL12CJ

### Bolt - Shipping Plate / Shaft

**Denso** 7SBU17C, SCSEA06, SCSC06

**Mats/Pan** H12A1AH4DX

**Zexel** DCS17E, DCS17IC

### **F20-2112** Bolt/Screw

Head Bolt (M8 x 1.25P x 150mm)



### Bolt - Head

**Denso** 10PA17SC, 10PA17SH, 10PA17VSC, 6CA17C

### Bolt - Head (10P15)

**Denso** 10P15 Series

### Bolt - Head (10PA17)

**Denso** 10PA17A, 10PA17C, 10PA17E, 10PA17H, 10PA17J, 10PA17K, 10PA17VC

### **F20-2114** Bolt/Screw

Housing Bolt



### Bolt - Housing

**Denso** 10S20C

### **F20-2116** Bolt/Screw

Muffler Bolt



### Bolt - Muffler

**Denso** 10S20C

### **F25-2100** Bolt/Screw

Shipping Plate Bolt (Flange Mount)

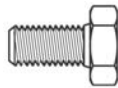

### Bolt - Shipping Plate

**Sanden** SD507, SD507A2, SD508, SD510

### **F25-2101** Bolt/Screw

Shaft Bolt



### Bolt - Shaft

**Nihon** NVR140S

### Bolt - Shipping Plate

**Sanden** TR105, TR105VS, TR70, TRF105, TRS105

### **F25-2102**

Shipping Plate / Oil Plug Bolt

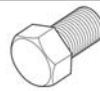

### Bolt/Screw

### Bolt - Oil Plug

**Denso** 6CA17C, 7SE16

### Bolt - Shipping Plate

**Diesel Kiki** DKS13G (DUAL), DKS13G (SINGLE), DKS13S, DKS15G, DKS15S, DKS17CH, DKS17S

**Sanden** SD6V12

### **F35-2101** Bolt/Screw

Shipping Plate Bolt



### Bolt - Shipping Plate

**Seiko-Seiki** SS170PSS

### **F40-2101** Bolt/Screw

Bolt - Shipping Plate (for Flat Top Models)



### Bolt - Shipping Plate (for Flat Top Models)

**York** 206, 209, 210, SC206, SC209

### **F45-2101** Bolt/Screw

Bolt - Shipping Plate



### Bolt - Shaft

**Diesel Kiki** DKV11G, DKV14G

### Bolt - Shipping Plate

**Denso** 10S11C, 10S11P, 10S13C, 10S13P, 10S15C, 10S15L, 10S17C, 10S20C, 10S20F, 10S20H, 6SEU12C, 6SEU14C, 6SEU16, SC08 (ITALY), SC08C (SPAIN), SC08C (USA), SCV06C, TV12C(R134), TV12SC(R134), TV14SC

**Mats/Pan** S1150F3, S1150X3

**Nihon** DKV14B, DKV14C

**Sanden** SD7B10

**Seiko-Seiki** SS10LV6, SS10V1, SS10V6

### **F50-2000** Bolt/Screw

Shaft Bolt



### Bolt - Shaft

**Calsonic** CWV615, CWV617,

### **F12-3101** Bushing

Mounting Bushing (Short) (0.395" - 10mm)



### Mounting Bushing (Short - 10mm)

**Ford** FS10, FS18, FX15

### **F12-3102**

Mounting Bushing (Long) (0.595" - 15mm)



### Bushing

### Mounting Bushing (Long - 15mm)

**Ford** FS10, FS18, FX15

### **F10-6211** Helical Insert

8-1.25 x 12mm Helical Insert



### Helical Insert - Shipping Plate (8-1.25 x 12mm)

**Mats/Pan** H12A1AH4DX

### Helical Insert - Case Bolt (8-1.25 x 12mm)

**Keihin** 150L, 150R

### Helical Insert - Manifold / Shipping Plate (8-1.25 x 12mm)

**Zexel** DCS17E

### Helical Insert - Rear Head / Shipping Plate (8-1.25 x 12mm)

**Calsonic** CR14, CWV615, CWV617, CWV618, DKV14D, V5-15C, V5-15F, V5-15G

**Chrysler** 6C17, A590, C171

**Delphi** CVC-125, CVC-135, CVC-135E, CVC-165, CVC-185, CVC6, CVC7P, SP10, SP15

**Denso** 10P08E, 10P13 Series, 10P15 Series, 10P17 Series, 10PA15A, 10PA15C, 10PA15E, 10PA15L, 10PA15LC, 10PA15SC, 10PA15VC, 10PA17A, 10PA17C, 10PA17E, 10PA17H, 10PA17J, 10PA17K, 10PA17SC, 10PA17SH, 10PA17VC, 10PA17VSC, 10PA20C, 10PA20H, 10P

**Diesel Kiki** DCV11A, DCV14A, DCV14J, DKS16H(R12), DKS16H(R134A), DKV11A, DKV11G, DKV14G, DKV14J

**Ford** FS10, FS6, FS6 CROSS MOUNT, FX15

**Hitachi** A5000, MJ110, MJ167, MJS130, MJS170, SWP167

**Mats/Pan** N1300AC4, N1301AB4, N1301AD4, N1301AE4, NL1300AA4, NL1300AB4, NL1300AE4, S1150AE4, SA1150AE4

**Mitsubishi** AX105VSR, FX105V, FX80, FXA105VS, FXA105VSLR, FXA105VSR, FXA105VSSS, MSC105CVS, MSC130CVSG, MSC130CVSG2, MSC90, MSC90C

**Nihon** DKV14C, NVR140S

**Sanden** PXE13, PXE16, PXV16, SD5H09, SD709CA, SD709CP, SD7C16, SD7H15, SD7V16, TR090, TR70, TRF090, TRS090

**Seiko-Seiki** SS10LV6, SS10V1, SS10V6, SS121DN1, SS121DN2, SS121DV2, SS96D1, SS96D2

## Fasteners

### Helical Insert - Rear Head / Shipping Plate (8-1.25 x 12mm)

**Visteon** HS090L, HS090R, HS110R, HS15, HS17, HS18

#### **F10-6217** Helical Insert

10-1.5mm x 20mm Helical Insert



### Helical Insert - Manifold Bolt (10-1.5mm x 20mm)

**GM/Harrison** A6, DA6, HD6, HR6, HR6HE, HT6, HU6, R4

#### **F10-6218** Helical Insert

10-1.5mm x 15mm Helical Insert



### Helical Insert - Manifold Bolt (10-1.5mm x 15mm)

**GM/Harrison** A6, DA6, HD6, HR6, HR6HE, HT6, HU6, R4

#### **F10-6219** Helical Insert

6 x 1 x 12mm Non-Locking Helical Insert



#### **F11-1110** Nut

Shaft Locknut



### Nut - Shaft

**Chrysler** 6C17, A590, C171

**Denso** 10P08E, 10P13 Series, 10P15 Series, 10P17 Series, 6E171, 6E171A, 6P Series

**Ford** FS6, FS6 CROSS MOUNT

**Hitachi** A5000, MJ110, MJ123, MJ167, MJS130, MJS170, SWP123, SWP167

**Mitsubishi** FX105V, FX80

**Sanden** PXE13, PXE16, SD6V12, SD7C16

**Visteon** HS090L, HS090R, HS110R

### Nut - Shipping Plate

**Denso** 10SR15C, 10SR17C

**Ford** FS18

**Hadsys** RC17D, RC17S

### Nut - Shipping Plate / Shaft

**Mitsubishi** MSC130CVSG, MSC130CVSG2

#### **F13-1002** Nut

Clutch Hub Locknut



### Locknut - Clutch Hub

**Calsonic** V5-15C, V5-15F, V5-15G

**Daewoo** V5

**GM/Harrison** DA6, HD6, HR6, HR6HE, HT6, HU6, V5, V5 (DESTROKER), V7

#### **F13-1101** Nut

Clutch Hub Locknut



### Locknut - Clutch Hub (Flanged)

**GM/Harrison** A6, R4

#### **F13-1120** Nut

Valve Plate Nut



### Nut - Valve Plate

**GM/Harrison** A6

#### **F10-4120** Retaining Ring

Coil Retainer (0.078" - 1.98mm Thick)



### Retaining Ring - Coil

**Denso** 6P127A, 6P127B, 6P127D

**Hitachi** A5000, MJ110, MJ123, MJ167, MJS130, MJS170

### Retaining Ring - Coil (1.98mm)

**Chrysler** 6C17, A590, C171

**Denso** 10P08E, 10P13 Series, 10P15 Series, 10P17 Series, 6E171, 6E171A, 6P134, 6P148, 6P148A, 6P148C

**Ford** FS6, FS6 CROSS MOUNT

**Sanden** SD505, SD507, SD507A2, SD508, SD510

#### **F10-4130** Retaining Ring

Clutch Retainer



### Retaining Ring - Clutch Coil

**Seiko-Seiki** SS10LV6, SS10V1, SS10V6

### Retaining Ring - Coil

**Denso** 10S11C, 10S11P, 10S13C, 10S13P, 10SR15C, 10SR17C, 5SL12CJ, 7SB16C, 7SBU16C, 7SBU17C, SC08 (ITALY), SC08C (SPAIN), SC08C (USA), SCS06C, SCSA06, SCSC06

### Retaining Ring - Piston Assembly / Clutch Coil

**Denso** 6CA17C

### Retaining Ring - Pulley

**Calsonic** V5-15C, V5-15F, V5-15G

**Chrysler** 6C17, A590, C171

**Daewoo** V5

**Denso** 10P08E, 10P13 Series, 10P15 Series, 10P17 Series, 6E171, 6E171A, 6P Series

**Ford** FS6, FS6 CROSS MOUNT

**GM/Harrison** A6, DA6, HD6, HR6, HR6HE, HT6, HU6, R4, V5, V5 (DESTROKER), V7

**Hitachi** A5000, MJ110, MJ123, MJ167, MJS130, MJS170

**Mitsubishi** FX105V, FX80

**Sanden** SD505, SD507, SD507A2, SD508, SD510

**Seiko-Seiki** SS96D1, SS96D2

### Retaining Ring, Small Rear Thrust Bearing

**Hadsys** RC17D, RC17S

#### **F11-4120** Retaining Ring

Coil Retainer (0.062" - 1.57mm)



### Retaining Ring - Coil (1.57mm)

**Chrysler** 6C17, A590, C171

**Denso** 10P08E, 10P13 Series, 10P15 Series, 10P17 Series, 6E171, 6E171A, 6P134, 6P148, 6P148A, 6P148C

**Ford** FS6, FS6 CROSS MOUNT

#### **F11-4121** Retaining Ring

Control Valve Retainer (0.062" - 1.57mm)



### Retaining Ring - Control Valve

**Denso** 5SL12CJ

**Zexel** DCS17IC

### Retaining Ring - Large Control Valve

**Chrysler** 6C17

### Retaining Ring - Rear Case Bearing

**Zexel** DCS17E

#### **F12-4110** Retaining Ring

Pulley Retainer (Beveled)



### Retaining Ring - Pulley

**Denso** 10PA15 Series, 10PA17 Series, 10PA20C, 10PA20H, 10PA20J, 10PA20SC, 10PA20SH, 10PA20VC, 10S15C, 10S15L, 10S17C, 10S20C, 10S20F, 10S20H, 10SR15C, 10SR17C, 5SL12CJ, TV10 Series, TV12 Series, TV14C, TV14SC

**Diesel Kiki** DKS17D

**Ford** FS10, FS18, FX15

**Mats/Pan** H12A1AH4DX

**Mitsubishi** MSC130CVSG, MSC130CVSG2

**Seiko-Seiki** SS10LV6, SS10V1, SS10V6, SS96D1, SS96D2

**Visteon** HS15, HS17, HS18

#### **F13-4110** Retaining Ring

Clutch Hub Retainer



### Retaining Ring - Clutch Hub

**GM/Harrison** A6

## Fasteners

### F13-4115 Retaining Ring

Switch Retainer



Retaining Ring - Compressor Switch

**Delphi** SP10

Retaining Ring - Control Valve

**Calsonic** CSV613, CWV615, CWV617, CWV618, V5-15C, V5-15F, V5-15G

**Delphi** CVC-125, CVC-135, CVC-165, CVC-185, CVC6, CVC7P

**GM/Harrison** V7

Retaining Ring - Control Valve / Switch Port

**Daewoo** V5

**GM/Harrison** V5, V5 (DESTROKER)

Retaining Ring - Lip Seal

**Ford** F500, FS10, FS18, FX15

**Visteon** VS12M, VS16, VS18M

Retaining Ring - Shaft Seal

**Visteon** HS15, HS17, HS18

Retaining Ring - Switch Port

**Denso** 10S15C, 10S15L, 10S17C, 10S20C, 10S20F

**GM/Harrison** A6, DA6, HD6, HR6, HR6HE, HT6, HU6, R4

Retaining Ring - Switch Port / Small Control Valve

**Chrysler** 6C17

### F13-4119 Retaining Ring

Shaft Seal Seat Retainer



Retaining Ring - Lip Seal

**Calsonic** DKV14D

**Diesel Kiki** DCV11A, DCV14A, DKV11A

**Nihon** DKV14C

Retaining Ring - Shaft Seal Seat

**GM/Harrison** A6

**Hitachi** MJ110, MJ123, MJ167, MJS130, SWP123, SWP167

**Keihin** 150L, 150R

**Nihon** DKV14B

### F13-4120 Retaining Ring

Lip Seal Beveled Retainer



Retaining Ring - Lip Seal (Beveled)

**Calsonic** V5-15C, V5-15F, V5-15G

**GM/Harrison** DA6, HD6, HR6, HR6HE, HT6, HU6, V5, V5 (DESTROKER)

Retaining Ring - Shaft Seal Seat (Beveled)

**GM/Harrison** A6, R4

### F13-4123 Retaining Ring

GM Pulley Retainer, Denso  
10PA Coil Retainer



Retaining Ring - Clutch Coil

**Denso** 10PA15 Series, 10PA17 Series, 10PA20C, 10PA20H, 10PA20J, 10PA20SC, 10PA20SH, 10PA20VC, 10S15C, 10S15L, 10S17C, 10S20C, 10S20F, TV10 Series, TV12 Series, TV14C, TV14SC

Washer - Head Bolt

**Denso** 10S20H

### F13-4125 Retaining Ring

Coil Beveled Retainer



Retaining Ring - Clutch Coil (Beveled)

**Calsonic** CSV613

**Delphi** CVC-125, CVC-135, CVC-165, CVC-185, CVC6, CVC7P

**Diesel Kiki** DCW17D

**Ford** F500

**GM/Harrison** A6

**Mitsubishi** MSC130CVSG, MSC130CVSG2

**Sanden** PXV16, SD6V12, SD7C16

**Visteon** HS090L, HS090R, HS110R, VS12M, VS18M

**Zexel** DCS171C

Retaining Ring - Piston Rotator (Beveled)

**Calsonic** V5-15C, V5-15F, V5-15G

**Daewoo** V5

**GM/Harrison** V5, V5 (DESTROKER)

Retaining Ring - Pulley (Beveled)

**Bosch** AXIAL

**Diesel Kiki** DCW17B

### F13-4141 Retaining Ring

Pickup Tube Retainer



Retaining Ring - Pickup Tube

**GM/Harrison** VIR

### F20-4000 Retaining Ring

Rear Head Switch Plug Retainer



Retaining Ring - Rear Head Sensor Port

**Denso** 10P15C, 10PA15C, 10PA15SC, 10PA17C, 10PA20C

### F20-4110 Retaining Ring

Lip Seal / Metal Shaft Seal Seat / Control Valve Retainer



Retaining Ring - Lip Seal

**Chrysler** 6C17

**Denso** 10PA15A, 10PA15C, 10PA15E, 10PA15L, 10PA15LC, 10PA15SC, 10PA15VC, 10PA17A, 10PA17C, 10PA17E, 10PA17H, 10PA17J, 10PA17K, 10PA17SC, 10PA17SH, 10PA17VC, 10PA17VSC, 10PA20C, 10PA20H, 10PA20J, 10PA20SC, 10PA20SH, 10PA20VC, TV12SC(R134), TV1

**Seiko-Seiki** SS170PSS

Retaining Ring - Lip Seal/Metal Shaft Seal Seat

**Denso** 10P08E

Retaining Ring - Shaft Seal Seat

**Chrysler** A590, C171

**Denso** 10P13 Series, 10P15 Series, 10P17 Series, 6E171, 6E171A, 6P Series, TV12C(R134)

**Ford** FS6, FS6 CROSS MOUNT

Retaining Ring - Thrust Washer Assembly

**Denso** 7SE16

### F20-4111 Retaining Ring

Pulley Retainer



Retaining Ring - Pulley

**Denso** 10PA15 Series, 10PA17 Series, 10PA20C, 10PA20H, 10PA20J, 10PA20SC, 10PA20SH, 10PA20VC, 10S15C, 10S15L, 10S17C, 10S20C, 10S20F, 10S20H, TV10 Series, TV12 Series, TV14C, TV14SC

### F25-4110 Retaining Ring

Shaft Seal Seat Beveled Retainer



Retaining Ring (Beveled) - Lip Seal

**Diesel Kiki** DCW17B, DCW17D, DKS16H(R134A)

**GM/Harrison** V7

**Sanden** SD5H09, SD5H11, SD5H13

Retaining Ring (Beveled) - Shaft Seal Seat

**Diesel Kiki** DKS16H(R12)

**Sanden** SD505, SD507, SD507A2, SD508, SD510

### F25-4111 Retaining Ring

Lip Seal Beveled Retainer



Front Case Bearing Retaining Ring

**Diesel Kiki** DCV14J

Retaining Ring - Lip Seal

**Calsonic** CSV613, CWV615, CWV617, CWV618

**Daewoo** V5

**Delphi** CVC-125, CVC-135, CVC-165, CVC-185, CVC6, CVC7P, SP10

## Fasteners

### Retaining Ring - Lip Seal

<b>Denso</b>	5SL12CJ, 6CA17C, 7SB16C, 7SBU16C, 7SE16, SC08 (ITALY), SC08C (SPAIN), SC08C (USA), SCS06C, SCSC06
<b>Diesel Kiki</b>	DCW17B, DCW17D, DKS15CH, DKS17CH, DKS17D
<b>GM/Harrison V5</b>	
<b>Hadsys</b>	RC17D, RC17S
<b>Sanden</b>	PXE13, PXE16, PXV16, SD6V12, SD709CA, SD709CP, SD7B10, SD7C16, SD7H13, SD7H15, SD7V16
<b>Seiko-Seiki</b>	SS10LV6, SS10V1, SS10V6, SS121DN1, SS121DN2, SS121DV2, SS96D1, SS96D2
<b>Tama</b>	TM08HD
<b>Zexel</b>	DCS171C

### Retaining Ring - Lip Seal / Control Valve

<b>Delphi</b>	CVC-135E
<b>Denso</b>	5SE09C, 5SE12C, 6SEU12, 6SEU12C, 6SEU14C, 6SEU16, 7SBU17C, 7SEU16, 7SEU17C
<b>Zexel</b>	DCS17E

### Retaining Ring - Shaft Seal Seat

<b>Sanden</b>	SD5H09, SD5H11, SD5H13, SD708, SD709
---------------	--------------------------------------

### Retaining Ring (Beveled) - Lip Seal

<b>GM/Harrison V7</b>	
-----------------------	--

### F25-4112 Retaining Ring

Pulley Retainer



### Retaining Ring - Clutch Pulley

<b>Calsonic</b>	CR14
<b>Delphi</b>	CVC-135E
<b>Denso</b>	5SE09C, 6CA17C, 7SB16C, 7SBU16C, 7SBU17C, 7SEU17C, SC08 (ITALY), SC08C (SPAIN), SC08C (USA)
<b>Diesel Kiki</b>	DCV11A, DCV14A, DCV14J, DKS13CH, DKS13G (DUAL), DKS13G (SINGLE), DKS13S, DKS15BH, DKS15CH, DKS15G, DKS15S, DKS17CH, DKS17G (DUAL), DKS17G (SINGLE), DKS17S, DKV11A
<b>Ford</b>	F500
<b>Mitsubishi</b>	MSC130CVSG, MSC130CVSG2
<b>Sanden</b>	PXE13, PXE16, SD6V12, SD708, SD709, SD709CA, SD709CP, SD7B10, SD7C16, SD7H15, SD7V16, TR090, TR105, TR105VS, TRF090, TRF105, TRS090, TRS105
<b>Tama</b>	TM08HD
<b>Visteon</b>	HS090L, HS090R, HS110R, VS12M, VS16, VS18M
<b>Zexel</b>	DCS17E, DCS171C

### Retaining Ring - Pulley

<b>Calsonic</b>	CSV613, DKV14D
-----------------	----------------

<b>Delphi</b>	CVC-125, CVC-135, CVC-165, CVC-185, CVC6, CVC7P
<b>Denso</b>	10S11C, 10S11P, 10S13C, 10S13P, 5SE12C, 6SEU12, 6SEU12C, 6SEU14C, 6SEU16, 7SE16, 7SEU16
<b>Diesel Kiki</b>	DCW17B, DCW17D, DKV11G, DKV14G
<b>Ford</b>	LARGE SCROLL, SCROLL
<b>GM/Harrison</b>	HD6, HT6
<b>Mats/Pan</b>	N1300AC4, N1301AB4, N1301AD4, N1301AE4, NL1300AA4, NL1300AB4, NL1300AE4
<b>Sanden</b>	PXV16, SD505, SD5H09, SD5H11, SD5H13
<b>Seiko-Seiki</b>	SS121DN1, SS121DN2, SS121DV2

### Retaining Ring - Pulley (Mercedes)

<b>Denso</b>	10PA15C, 10PA17C
--------------	------------------

### F30-4000 Retaining Ring

Shaft Seal Retainer



### Retaining Ring - Contol Valve

<b>Visteon</b>	VS12M, VS16
----------------	-------------

### Retaining Ring - Contol Valve / Case Thrust Bearing Spring

<b>Ford</b>	F500
-------------	------

### Retaining Ring - Contol Valve and Shaft Spring

<b>Visteon</b>	VS18M
----------------	-------

### Retaining Ring - Lip Seal

<b>Delphi</b>	SP15
<b>Hitachi</b>	A5000, MJS170
<b>Seiko-Seiki</b>	SS121DN1, SS121DN2, SS121DV2

### Retaining Ring - Shaft Seal Seat

<b>Diesel Kiki</b>	DKS13G (DUAL), DKS13G (SINGLE), DKS13S, DKS15BH, DKS15G, DKS15S, DKS17G (DUAL), DKS17G (SINGLE), DKS17S
--------------------	---

### F55-4000 Retaining Ring

Lip Seal / Rear Case Bearing Retainer



### Retaining Ring - Lip Seal

<b>Ford</b>	LARGE SCROLL, SCROLL
<b>Mats/Pan</b>	H12A1AH4DX
<b>Mitsubishi</b>	AX105VSR, FXA105VS, FXA105VSLR, FXA105VSR, FXA105VSSR, MSC105CVS, MSC105VSR, MSC130CVSG, MSC130CVSG2
<b>Sanden</b>	TRSA09, TRSA12, TRSE07
<b>Visteon</b>	HS090L, HS090R, HS110R

### Retaining Ring - Shaft Seal Seat

<b>Mitsubishi</b>	FX105V, FX80, MSC90, MSC90C
-------------------	-----------------------------

<b>Sanden</b>	TR090, TR105, TR105VS, TR70, TRF090, TRF105, TRS090, TRS105
---------------	---

### F13-7101 Rivet/Pin

Piston Rivet (For P13-4100)



### Rivet - Discharge Valve

<b>Visteon</b>	VS18M
----------------	-------

### Rivet - Piston (For P13-4100)

<b>GM/Harrison R4</b>	
-----------------------	--

### F13-7103 Rivet/Pin

Valve Plate Rivet



### Rivet - Valve Plate

<b>GM/Harrison R4</b>	
-----------------------	--

### F13-7105 Rivet/Pin

Valve Plate Rivet



### Rivet - Discharge Reed

<b>GM/Harrison</b>	HD6, HT6
--------------------	----------

### Rivet - Valve Plate

<b>Calsonic</b>	CSV613
-----------------	--------

<b>Daewoo</b>	V5
---------------	----

<b>Delphi</b>	CVC-125, CVC-135, CVC-135E, CVC-165, CVC-185, CVC6, CVC7P
---------------	---

<b>Diesel Kiki</b>	DKS15BH
--------------------	---------

<b>GM/Harrison</b>	A6, DA6, HR6, HR6HE, HU6, V5
--------------------	------------------------------

### Rivet - Valve Plate / Clutch Hub

<b>Calsonic</b>	V5-15C, V5-15F, V5-15G
-----------------	------------------------

### F13-7106 Rivet/Pin

Piston Rivet



### Rivet - Piston

<b>GM/Harrison</b>	HD6, HT6, HU6
--------------------	---------------

### F13-7107 Rivet/Pin

Valve Plate Rivet



### Rivet - Valve Plate

<b>GM/Harrison V7</b>	
-----------------------	--

### Rivet (w/out Hole) - Valve Plate (Destroyer)

<b>Daewoo</b>	V5
---------------	----

<b>GM/Harrison</b>	V5 (DESTROKER)
--------------------	----------------

### F13-7108 Rivet/Pin

Valve Plate Rivet w/ Center Hole



### Rivet (w/ Hole) - Valve Plate (Destroyer)

<b>GM/Harrison</b>	V5 (DESTROKER)
--------------------	----------------

## Fasteners

### F13-7110 Rivet/Pin

Spring Pin (7/32" x 3/4")



*Spring Pin (3/4") - Crank*

GM/Harrison R4

### F13-7111 Rivet/Pin

Spring Pin (7/32" x 9/16")



*Spring Pin (9/16") - Crank*

GM/Harrison R4

### F20-7102 Rivet/Pin

Denso constant drive hub and pulley assembly rivet



*Denso constant drive hub and pulley assembly rivet*

Denso 6SEU12

*Rivet - Generation I Direct Drive Hub*

Denso 6SEU12C, 6SEU14C

### F11-5110 Shaft Key



*Shaft Key*

Chrysler RV2

Keihin 150L, 150R

### F11-5120 Shaft Key

(Short) (.470" / 11.9mm Length x .158" / 4.0mm Width)



*Shaft Key (Short - 11.9mm x 4.0mm)*

Chrysler 6C17

Denso 10P08E, 10P13 Series, 10P15 Series, 10P17 Series, 6E171, 6E171A, 6P Series

Ford FS6, FS6 CROSS MOUNT

*Shaft Key (Short - 11.9mm x 4.0mm) (A590)*

Chrysler A590

### F13-5110 Shaft Key



*Shaft Key*

Calsonic V5-15C, V5-15F, V5-15G

Daewoo V5

Diesel Kiki DKS16H(R12), DKS16H(R134A)

GM/Harrison A6, R4, V5, V5 (DESTROKER), V7

### F25-5105 Shaft Key



*Shaft Key*

Sanden SD505, SD708, SD709, SD709CA, SD709CP, SD7B10

### F25-5110 Shaft Key



*Shaft Key*

Sanden SD507, SD507A2, SD508, SD510, SD5H09, SD5H11, SD5H13, SD7H15

### F40-5110 Shaft Key



*Shaft Key*

Tecumseh HG1000, HG500, HG850  
York 206, 209, 210, SC206, SC209

### F10-9155 Tye Wrap

7" Black Tye Wrap



### F10-9160 Tye Wrap

11" Black Tye Wrap



### F10-9165 Tye Wrap

14" Black Tye Wrap



### F11-3105 Washer/Shim

Shim (0.008" - 0.20mm)



*Shim - Clutch (0.20mm)*

Calsonic CWV615, CWV617,

Chrysler 6C17, A590, C171

Denso 10P08E, 10P13 Series, 10P15 Series, 10P17 Series, 10PA15 Series, 10PA17 Series, 10PA20C, 10PA20H, 10PA20J, 10PA20SC, 10PA20SH, 10PA20VC, 10S11C, 10S11P, 10S13C, 10S13P, 10S15C, 10S15L, 10S17C, 10S20C, 10S20F, 10S20H, 10SR15C, 10SR17

Diesel Kiki DCV11A, DCV14A, DCW17B, DCW17D, DKS13S, DKS15BH, DKS15CH, DKS15G, DKS15S, DKS16H(R12), DKS16H(R134A), DKS17CH, DKS17G (DUAL), DKS17G (SINGLE), DKS17S, DKV11A

Ford FS6, FS6 CROSS MOUNT

Hitachi A5000, MJ110, MJ123, MJ167, MJS130, MJS170, SWP123, SWP167

Nihon DKV14B, DKV14C

### F11-3110 Washer/Shim

Shaft Lockwasher



*Lockwasher - Shaft*

Chrysler 6C17, A590, C171

Denso 10P08E, 10P13 Series, 10P15 Series, 10P17 Series, 6E171, 6E171A, 6P Series

Ford FS6, FS6 CROSS MOUNT

Hitachi A5000, MJ110, MJ123, MJ167, MJS130, MJS170, SWP123, SWP167

### F11-3111 Washer/Shim

Head Bolt Washer



*Washer - Head Bolt*

Behr WINGCELL

Calsonic CWV615, CWV617,

Chrysler 6C17, A590, C171

Denso 10P08E, 10P13 Series, 10P15 Series, 10P17 Series, 10PA15 Series, 10PA17 Series, 10PA20C, 10PA20H, 10PA20J, 10PA20SC, 10PA20SH, 10PA20VC, 6CA17C, 6E171, 6E171A, 6P Series, 7SB16C, TV10 Series, TV12 Series, TV14 Series

Diesel Kiki DKS15CH, DKS17CH

Ford FS6, FS6 CROSS MOUNT

Nihon DKV14C

Seiko-Seiki SS170PSS

Tama TM08HD

### F11-3115 Washer/Shim

Clutch Shim (0.020" - 0.51mm)



*Shim - Clutch (0.20mm)*

Denso TV10 Series, TV12C(R12), TV12EC(R12), TV12SC(R134), TV14 Series

*Shim - Clutch (0.51mm)*

Calsonic CWV615, CWV617,

Chrysler 6C17, A590, C171

## Fasteners

### Shim - Clutch (0.51mm)

**Denso** 10P08E, 10P13 Series, 10P15 Series, 10P17 Series, 10PA15 Series, 10PA17 Series, 10PA20C, 10PA20H, 10PA20J, 10PA20SC, 10PA20SH, 10PA20VC, 10S11C, 10S11P, 10S13C, 10S13P, 10S15C, 10S15L, 10S17C, 10S20C, 10S20F, 10S20H, 10SR15C, 10SR17

**Diesel Kiki** DCV11A, DCV14A, DCW17B, DCW17D, DKS15BH, DKS15CH, DKS16H(R12), DKS16H(R134A), DKS17CH, DKS17G (DUAL), DKS17G (SINGLE), DKV11A

**Ford** FS6, FS6 CROSS MOUNT

**Hitachi** A5000, MJ110, MJ123, MJ167, MJS130, MJS170, SWP123, SWP167

**Nihon** DKV14B, DKV14C

### Shim - Clutch (0.51mm)/Head Bolt Washer

**Diesel Kiki** DKS13S, DKS15G, DKS17S

### Shim - Clutch (0.51mm)/Head Bolt Washer

**Diesel Kiki** DKS15S

### F12-3105 Washer/Shim

Shipping Plate Washer



### Washer - Shipping Plate (Use with C12-4105)

**Ford** FS10, FX15

### F12-3110 Washer/Shim

Clutch Shim (0.015" - 0.38mm)



### Shim - Clutch (0.38mm)

**Calsonic** CWV615, CWV617,

**Chrysler** A590, C171

**Denso** 10PA15 Series, 10PA17 Series, 10PA20C, 10PA20H, 10PA20J, 10PA20SC, 10PA20SH, 10PA20VC, 10S11C, 10S11P, 10S13C, 10S13P, 10S15C, 10S15L, 10S17C, 10S20C, 10S20F, 10S20H, 10SR15C, 10SR17C, 6E171, 6E171A, 7SB16C, TV10 Series, TV12 Serie

**Diesel Kiki** DCV11A, DCV14A, DCW17B, DCW17D, DKS13S, DKS15BH, DKS15CH, DKS15G, DKS15S, DKS17CH, DKS17G (DUAL), DKS17G (SINGLE), DKS17S, DKV11A

**Ford** FS10, FS18, FX15

**Mats/Pan** N1300AC4, N1301AB4, N1301AD4, N1301AE4, N1300AA4, N1300AB4, N1300AE4, S1150F3, S1150X3, SA1150AE4

**Nihon** DKV14B, DKV14C

**Seiko-Seiki** SS170PSS

**Visteon** HS15, HS17, HS18, VS12M

### F13-3104 Washer/Shim

Tab Washer



### Washer - Tab

**GM/Harrison R4**

### F13-3105 Washer/Shim

Belleville Washer



### Washer - Belleville

**GM/Harrison R4**

### F13-3111 Washer/Shim

Head Bolt Washer



### Washer - Head Bolt

**Calsonic** CSV613, V5-15C, V5-15F, V5-15G

**Daewoo** V5

**Denso** 10S11C, 10S11P, 10S13C, 10S13P, 10S15C, 10S15L, 10S17C, 10S20C, 10S20F, 10SR15C, 10SR17C

**GM/Harrison** DA6, HR6, HR6HE, V5, V5 (DESTROKER), V7

### F13-3113 Washer/Shim

Tang Washer (Thick) (Late Model)



### Washer - Tang (Thick) (Late Model)

**GM/Harrison R4**

### F13-3114 Washer/Shim

Rear Crank Washer



### Washer - Head Bolt

**Denso** 6SEU12, 6SEU12C, 6SEU14C, 6SEU16, 7SE16

**GM/Harrison** HD6, HT6

### Washer - Oil Drain Bolt

**Visteon** VS18M

### F20-3000 Washer/Shim

Head Bolt Washer



### Shim

**Visteon** VS12M

### Washer - Head Bolt

**Delphi** CVC-135E, CVC-165, CVC-185, CVC7P

**Denso** 5SE09C, 5SE12C, 5SL12CJ, 7SEU17C, SC5A06, SC5C06

**Sanden** PXE13, PXE16, PXV16

**Visteon** VS16, VS18M

**Zexel** DCS17E, DCS17IC

### F25-3101 Washer/Shim

Clutch Shim (Notched) (0.005" - 0.13mm)



### Shim (Notched) - Clutch (0.13mm)

**Sanden** SD507, SD507A2, SD508, SD510, SD5H09, SD5H13, SD708, SD709, SD709CA, SD709CP, SD7B10, SD7H15

### F25-3104 Washer/Shim

Clutch Shim (Notched) (0.032" - 0.81mm)



### Shim (Notched) - Clutch (0.81mm)

**Sanden** SD507, SD507A2, SD508, SD510, SD5H09, SD5H13, SD708, SD709, SD709CA, SD709CP, SD7B10, SD7H15

### F25-3105 Washer/Shim

Clutch Shim (Notched) (0.020" - 0.51mm)



### Shim (Notched) - Clutch (0.51mm)

**Sanden** SD507, SD507A2, SD508, SD510, SD5H09, SD5H13, SD708, SD709, SD709CA, SD709CP, SD7B10, SD7H15

### F25-3106 Washer/Shim

Clutch Shim (Notched) (0.005" - 0.13mm)



### Shim (Notched) - Clutch (0.13mm)

**Sanden** SD505

### F25-3107 Washer/Shim

Clutch Shim (Notched) (0.020" - 0.51mm)



### Shim (Notched) - Clutch (0.51mm)

**Sanden** SD505

### F25-3109 Washer/Shim

Clutch Shim (0.030" - 0.76mm)



### Shim - Clutch (0.76mm)

**Calsonic** CSV613

**Delphi** CVC-125, CVC-135, CVC-135E, CVC6

**Diesel Kiki** DCV14J, DKV11G, DKV14G, DKV14J

**Mats/Pan** H12A1AH4DX

**Visteon** VS16, VS18M

## Fasteners

### F25-3110 Washer/Shim

Clutch Shim (Notched)  
(0.040" - 1.02mm)



Shim (Notched) - Clutch (1.02mm)

**Sanden** SD507, SD507A2, SD508, SD510, SD5H09, SD5H13, SD708, SD709, SD709CA, SD709CP, SD7B10, SD7H15

### F25-3111 Washer/Shim

Clutch Shim (0.015" - 0.38mm)



Shim - Clutch (0.38mm)

**Calsonic** CSV613  
**Delphi** CVC-125, CVC-135, CVC-135E, CVC6  
**Diesel Kiki** DCV14J, DKV11G, DKV14G, DKV14J  
**Mats/Pan** H12A1AH4DX  
**Visteon** VS16, VS18M

### F25-3112 Washer/Shim

Clutch Shim (0.015" - 0.38mm)



Shim - Clutch (0.38mm)

**Ford** LARGE SCROLL, SCROLL  
**Mitsubishi** AX105VSR, FX105V, FX80, FXA105VS, FXA105VSLR, FXA105VSR, FXA105VSSS  
**Sanden** TR090, TR105, TR105VS, TRF090, TRF105, TRS090, TRS105, TRSA09, TRSE07  
**Visteon** HS090L, HS090R, HS110R

### F25-3113 Washer/Shim

Clutch Shim (0.030" - 0.76mm)



Shim - Clutch (0.76mm)

**Ford** LARGE SCROLL, SCROLL  
**Mitsubishi** AX105VSR, FX105V, FX80, FXA105VS, FXA105VSLR, FXA105VSR, FXA105VSSS  
**Sanden** TR090, TR105, TR105VS, TRF090, TRF105, TRS090, TRS105, TRSA09, TRSE07  
**Visteon** HS090L, HS090R, HS110R

### F25-3114 Washer/Shim

Clutch Shim (0.010" - 0.25mm)



Shim - Clutch (0.25mm)

**Sanden** PXE13, PXE16, PXV16

### F25-3120 Washer/Shim

Clutch Shim (0.010" - 0.25mm)



Shim - Clutch (0.25mm)

**Sanden** TR70

### F40-3101 Washer/Shim

Oil Plug Copper Washer



Washer (Copper) - Oil Plug

**Tecumseh** HG1000, HG500, HG850

### F60-3110 Washer/Shim

Clutch Shim (0.005" - 0.13mm)



Shim - Clutch (0.13mm)

**Keihin** 150L, 150R

**Sanden** SD7C16, SD7V16

### K12-5104

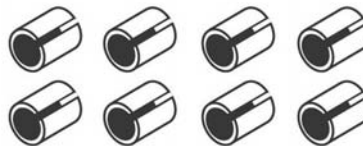

Includes: Mounting Bushing (Long - 0.595" - 15 mm Long) (8)

Mounting Bushing Kit

**Ford** FS10, FS18, FX15

### K12-5105



Includes: Mounting Bushing (Short - 0.395" - 10 mm Long) (2), Mounting Bushing (Long - 0.595" - 15 mm Long) (2), Clutch Shim (0.015" - 0.38mm Thick) (6), Pulley Retaining Ring (1), Shaft Bolt (1)

Mounting Shim Kit

**Ford** FS10, FS18, FX15

### K12-5110



Includes: Clutch Shim (0.015" - 0.38mm Thick) (6), Pulley Retaining Ring (1), Shaft Bolt (1)

Clutch Installation Kit

**Ford** FS10, FS18, FX15

### Visteon HS15, HS17, HS18

### K13-5110



Includes: Clutch to Pulley Retaining Ring (1), Flanged Clutch Hub Nut (1), Clutch Hub Retaining Ring (1), Switch Port Retaining Ring (1), Shaft Seal Seat Retaining Ring (Beveled) (1), Coil Retaining Ring (Beveled) (1)

Retaining Ring Kit

**GM/Harrison A6**

### K20-5010

w/o Shaft Key



Includes: Coil Retaining Ring (0.078" - 1.198 mm Thick) (1), Coil Retaining Ring - (0.062" - 1.57 mm Thick) (1), Pulley Retaining Ring (1), Shaft Locknut (1), Shaft Lockwasher (1), Hub Shim - .020" Thick (5)

Clutch Installation Kit

**Denso** 10P08E, 10P13 Series, 10P15 Series, 10P17 Series, 6E171, 6E171A, 6P Series

### K20-5107



Includes: Coil Retaining Ring (1), Pulley Retaining Ring (1), Shaft Bolt (1), Shim (0.20mm) (1), Shim (0.38mm) (1), Shim (0.51mm) (1).

Clutch Installation Kit

**Denso** 10PA15 Series, 10PA17 Series, 10PA20C, 10PA20H, 10PA20J, 10PA20SC, 10PA20SH, 10PA20VC, 10S15C, 10S15L, 10S17C, 10S20C, 10S20F, TV10 Series, TV12 Series, TV14 Series

## Fasteners

### K20-5110

w/ Shaft Key



Includes: Coil Retaining Ring (0.078" - 1.198 mm Thick) (1), Coil Retaining Ring - (0.062 - 1.57 mm Thick) (1), Pulley Retaining Ring (1), Shaft Locknut (1), Shaft Lockwasher (1), Hub Shim - .020" Thick (5), Shaft Key (Long) (1), Shaft Key (Short) (1)

#### Clutch Installation Kit

**Chrysler** 6C17, A590, C171

**Denso** 10P08E, 10P13 Series,  
10P15 Series, 10P17 Series, 6E171,  
6E171A, 6P Series

**Ford** FS6, FS6 CROSS MOUNT



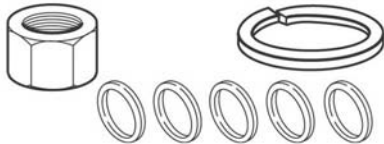

























### K40-5101

































Includes: Clutch Washer (1), Clutch Nut (1), Clutch Shim (5).

































## Gaskets

<b>G11-1110</b> Rear Head <b>Chrysler</b> 6C17 <b>Fiber</b>		<b>G20-1132</b> Rotor Pressure By-Pass <b>Denso</b> TV12EC(R12), TV14C, TV14EC <b>Fiber</b>		<b>G25-1100</b> Cylinder <b>Sanden</b> SD709CA <b>Fiber</b>	
<b>G11-1168</b> Suction Port <b>Chrysler</b> RV2 <b>Fiber</b>		<b>G20-1133</b> Front Head <b>Denso</b> TV12EC(R12), TV12SC(R134), TV14EC, TV14SC <b>Fiber</b>		<b>G25-1101</b> Head <b>Sanden</b> SD709CA <b>Fiber</b>	
<b>G11-1169</b> Discharge Port <b>Chrysler</b> RV2 <b>Fiber</b>		<b>G20-1134</b> Rear Head <b>Denso</b> TV12C(R134), TV12SC(R134), TV14SC <b>Fiber</b>		<b>G25-1102</b> Head <b>Sanden</b> SD709CP <b>Fiber</b>	
<b>G13-1172</b> Head <b>Delphi</b> SP10 <b>Fiber</b>		<b>G20-1135</b> Front Head <b>Denso</b> 7SB16C, 7SBU16C <b>Fiber</b>		<b>G25-1103</b> Cylinder <b>Sanden</b> SD709CP <b>Fiber</b>	
<b>G13-1173</b> Front Head <b>Calsonic</b> CSV613 <b>Delphi</b> CVC-125, CVC-135, CVC-135E, CVC6 <b>Fiber</b>		<b>G20-1136</b> Rear Head <b>Denso</b> 7SB16C <b>Fiber</b>		<b>G25-1110</b> Cylinder - Rover/Jaguar <b>Sanden</b> SD7H15 <b>Fiber</b>	
<b>G13-1174</b> Rear Head <b>Calsonic</b> CSV613 <b>Delphi</b> CVC-125, CVC-135, CVC-135E, CVC6 <b>Fiber</b>		<b>G20-1137</b> Cylinder <b>Denso</b> 7SB16C <b>Fiber</b>		<b>G25-1151</b> Head <b>Sanden</b> SD505, SD507, SD507A2, SD508, SD510, SD5H09, SD5H11, SD5H13 <b>Fiber</b>	
<b>G20-1110</b> Head <b>Denso</b> 6P134 <b>Fiber</b>		<b>G20-1349</b> Cylinder <b>Denso</b> 10S11C, 10S11P, 10S13C, 10S13P <b>Fiber</b>		<b>G25-1153</b> Head <b>Sanden</b> SD7B10 <b>Fiber</b>	
<b>G20-1120</b> Head <b>Denso</b> 6P127A, 6P127B, 6P127D, 6P148, 6P148A, 6P148C <b>Fiber</b>		<b>G20-1350</b> Center Case <b>Denso</b> 10S13C, 10S13P <b>Fiber</b>		<b>G25-1154</b> Cylinder <b>Sanden</b> SD7B10 <b>Fiber</b>	
<b>G20-1130</b> Front Head <b>Denso</b> TV12C(R12), TV12C(R134), TV14C <b>Fiber</b>		<b>G20-1354</b> Center Case - Late Model <b>Denso</b> 10S11C, 10S11P <b>Fiber</b>		<b>G25-1163</b> Head <b>Sanden</b> SD7V16 <b>Fiber</b>	
<b>G20-1131</b> Rear Head <b>Denso</b> TV12C(R12), TV12EC(R12), TV14C, TV14EC <b>Fiber</b>		<b>G20-1355</b> Center Case - Early Model - New Fiber <b>Denso</b> 10S11C, 10S11P <b>Fiber</b>		<b>G25-1164</b> Cylinder <b>Sanden</b> SD7V16 <b>Fiber</b>	



























## Gaskets

<b>G25-1165</b> Rear Head <b>Sanden</b> SD6V12	<b>Fiber</b> 	<b>G30-1124</b> Front Head <b>Diesel Kiki</b> DKS13CH, DKS13S, DKS15CH, DKS15S, DKS17CH	<b>Fiber</b> 	<b>G40-1172</b> Cylinder <b>Tecumseh</b> HG1000, HG850	<b>Fiber</b> 
<b>G25-1166</b> Cylinder <b>Sanden</b> SD6V12	<b>Fiber</b> 	<b>G30-1125</b> Front Head <b>Diesel Kiki</b> DKS17S	<b>Fiber</b> 	<b>G45-1100</b> Front Head <b>Nihon</b> DKV14C	<b>Fiber</b> 
<b>G30-1101</b> Front Head <b>Diesel Kiki</b> DKS15BH	<b>Fiber</b> 	<b>G30-1126</b> Rear Head <b>Diesel Kiki</b> DKS17S	<b>Fiber</b> 	<b>G45-1101</b> Rear Head <b>Nihon</b> DKV14C	<b>Fiber</b> 
<b>G30-1102</b> Rear Head <b>Diesel Kiki</b> DKS15BH	<b>Fiber</b> 	<b>G30-1127</b> Head <b>Tama</b> TM08, TM08HD	<b>Fiber</b> 	<b>G45-1102</b> Rear Head <b>Diesel Kiki</b> DCV11A, DCV14A, DKV11A	<b>Fiber</b> 
<b>G30-1103</b> Front Head <b>Diesel Kiki</b> DKS16H(R12), DKS16H(R134A)	<b>Fiber</b> 	<b>G30-1129</b> Rear Head <b>Diesel Kiki</b> DKS13S, DKS15S	<b>Fiber</b> 	<b>G45-1103</b> Front Head <b>Calsonic</b> DKV14D <b>Diesel Kiki</b> DCV11A, DCV11D, DCV14A, DKV11A, DKV11D	<b>Fiber</b> 
<b>G30-1104</b> Rear Head <b>Diesel Kiki</b> DKS16H(R12), DKS16H(R134A)	<b>Fiber</b> 	<b>G40-1101</b> Service Valve <b>Tecumseh</b> HG1000, HG850 <b>York</b> 206, 209, 210	<b>Fiber</b> 	<b>G50-1101</b> Head <b>Mats/Pan</b> N1300AC4, NL1300AA4, NL1300AB4, NL1300AE4	<b>Fiber</b> 
<b>G30-1120</b> Head <b>Diesel Kiki</b> DKS13G (DUAL), DKS13G (SINGLE), DKS15G	<b>Fiber</b> 	<b>G40-1104</b> Circular - Seal Plate <b>Tecumseh</b> HG1000, HG500, HG850 <b>York</b> 206, 209, 210	<b>Fiber</b> 	<b>G50-1102</b> Head <b>Mats/Pan</b> SA1150AE4	<b>Fiber</b> 
<b>G30-1121</b> Intermediate Head <b>Diesel Kiki</b> DKS13G (DUAL)	<b>Fiber</b> 	<b>G40-1149</b> Base Plate <b>York</b> 206, 209, 210	<b>Fiber</b> 	<b>G50-1103</b> Head <b>Mats/Pan</b> N1301AB4, N1301AD4, N1301AE4	<b>Fiber</b> 
<b>G30-1122</b> Rear Head <b>Diesel Kiki</b> DKS13G (DUAL)	<b>Fiber</b> 	<b>G40-1160</b> Cylinder <b>York</b> SC206, SC209	<b>Fiber</b> 	<b>G65-1100</b> Front Case <b>Hitachi</b> A5000, MJ110, MJ123, MJ167, MJS130, SWP123	<b>Fiber</b> 
<b>G30-1123</b> Rear Head <b>Diesel Kiki</b> DKS13CH, DKS15CH, DKS17CH	<b>Fiber</b> 	<b>G40-1162</b> Base Plate <b>York</b> SC206, SC209	<b>Fiber</b> 	<b>G65-1101</b> Front Case <b>Hitachi</b> MJS170, SWP167	<b>Fiber</b> 

## Gaskets

<b>G65-1102</b> Cylinder (31.9mm Bore) <b>Hitachi</b> MJ110	Fiber 	<b>G95-1102</b> Head <b>Bosch</b> AXIAL	Fiber 	<b>G11-2152</b> Head <b>Chrysler</b> RV2	Metal 
<b>G65-1103</b> Cylinder (37.0mm Bore) <b>Hitachi</b> MJ110, MJ123	Fiber 	<b>G13-1103</b> <b>GM/Harrison</b> A6	Foam Rubber 	<b>G11-2153</b> Cylinder <b>Chrysler</b> RV2	Metal 
<b>G65-1104</b> Front Head <b>Hitachi</b> A5000, SWP123, SWP167	Fiber 	<b>G11-2100</b> Suction Port (Alternate) <b>Chrysler</b> RV2	Metal 	<b>G11-2161</b> Head <b>Chrysler</b> A590, C171 <b>Denso</b> 6E171, 6E171A	Metal 
<b>G65-1105</b> Rear Head <b>Hitachi</b> A5000, SWP123, SWP167	Fiber 	<b>G11-2101</b> Suction Port <b>Chrysler</b> RV2	Metal 	<b>G11-2164</b> Discharge Port <b>Denso</b> 10S15C, 10S15L, 10S17C, 10S20C, 10S20F	Metal 
<b>G65-1106</b> Cylinder <b>Hitachi</b> SWP123, SWP167	Fiber 	<b>G11-2102</b> Discharge Port <b>Chrysler</b> RV2	Metal 	<b>G11-2165</b> Suction Port <b>Denso</b> 10S15C, 10S15L, 10S17C, 10S20C, 10S20F	Metal 
<b>G65-1108</b> Side Plate <b>Hitachi</b> A5000, SWP123, SWP167	Fiber 	<b>G11-2103</b> Suction / Discharge Port <b>Chrysler</b> A590, C171	Metal 	<b>G11-2166</b> Suction Port (Jeep Only) <b>Denso</b> 10S15C, 10S15L, 10S17C, 10S20C, 10S20F	Metal 
<b>G75-1000</b> Rear Head <b>Calsonic</b> DKV14D <b>Diesel Kiki</b> DCV11D, DKV11D	Fiber 	<b>G11-2104</b> Discharge Port (1/2") <b>Chrysler</b> 6C17	Metal 	<b>G12-2151</b> Head <b>Ford</b> FS6, FS6 CROSS MOUNT	Metal 
<b>G75-1001</b> Front Head <b>Calsonic</b> CWV615, CWV617, CWV618	Fiber 	<b>G11-2105</b> Suction Port (5/8") <b>Chrysler</b> 6C17	Metal 	<b>G12-2152</b> Head <b>Calsonic</b> CWV615, CWV617, CWV618	Metal 
<b>G75-1002</b> Rear Head <b>Calsonic</b> CWV615, CWV617, CWV618	Fiber 	<b>G11-2106</b> Suction / Discharge Port (1991 and later) <b>Chrysler</b> 6C17	Metal 	<b>G12-2153</b> Head <b>Chrysler</b> RV2	Metal 
<b>G95-1101</b> Cylinder <b>Bosch</b> AXIAL	Fiber 	<b>G11-2151</b> Base Plate <b>Chrysler</b> RV2	Metal 	<b>G12-2161</b> Head (Early) <b>Ford</b> FX15	Metal 































## Gaskets

<b>G12-2162</b> Metal		<b>G13-2171</b> Metal		<b>G20-2002</b> Metal	
Head (Mid)		Head Gasket w/ (6.8 x 7.7mm Oval Bolt Hole)		Front Head	
<b>Ford</b> FX15		<b>Calsonic</b> V5-15C, V5-15F, V5-15G		<b>Denso</b> 10PA20C, 10PA20H, 10PA20J, 10PA20SC, 10PA20SH, 10PA20VC	
<b>G12-2163</b> Metal		<b>Daewoo</b> V5		<b>G20-2003</b> Metal	
Head (Late)		<b>GM/Harrison</b> V5, V5 (DESTROKER)		Rear Head	
<b>Ford</b> FX15		<b>G13-2172</b> Metal		<b>Denso</b> 10PA20C, 10PA20H, 10PA20J, 10PA20SC, 10PA20SH	
<b>G12-2164</b> Metal		Head Gasket w/ (8.0 x 8.3mm Oval Bolt Hole)		<b>G20-2010</b> Metal	
Head		<b>Daewoo</b> V5		Center Case	
<b>Ford</b> FS10		<b>GM/Harrison</b> V5, V5 (DESTROKER)		<b>Denso</b> 10S15C, 10S15L, 10S17C, 10S20C, 10S20F, 10S20H	
<b>G12-2180</b> Metal		<b>G13-2173</b> Metal		<b>G20-2011</b> Metal	
Visteon VS16 Front Head Gasket (Metal)		Cylinder		Front Cylinder	
<b>Visteon</b> VS16		<b>GM/Harrison</b> V7		<b>Denso</b> 10S15C, 10S15L, 10S17C, 10S20C, 10S20F, 10S20H	
<b>G12-2181</b> Metal		<b>G13-2174</b> Metal		<b>G20-2012</b> Metal	
Visteon VS16 Cylinder Gasket (Metal)		Front Head		Rear Head	
<b>Visteon</b> VS16		<b>GM/Harrison</b> V7		<b>Denso</b> 10S15C, 10S15L, 10S17C, 10S20C, 10S20F, 10S20H	
<b>G12-2182</b> Metal		<b>G13-2175</b> Metal		<b>G20-2013</b> Metal	
Visteon VS16 Rear Head Gasket (Metal)		Delphi CVC-135E Front Head Gasket (Metal)		Front Head	
<b>Visteon</b> VS16		<b>Calsonic</b> CSV613		<b>Denso</b> 10S15C, 10S15L, 10S17C, 10S20C, 10S20F, 10S20H	
<b>G13-2161</b> Metal		<b>Delphi</b> CVC-125, CVC-135, CVC-135E, CVC6		<b>G20-2014</b> Metal	
Head Gasket w/ (6.9mm Bolt Holes)		<b>G13-2176</b> Metal		Rear Cylinder	
<b>GM/Harrison</b> DA6, HR6		Delphi CVC-135E Rear Head Gasket (Metal)		<b>Denso</b> 10S15C, 10S15L, 10S17C, 10S20C, 10S20F, 10S20H	
<b>G13-2162</b> Metal		<b>Calsonic</b> CSV613		<b>G20-2015</b> Metal	
Head Gasket w/ (7.8mm Bolt Holes)		<b>Delphi</b> CVC-125, CVC-135, CVC-135E, CVC6		Rear Head (Late Models)	
<b>GM/Harrison</b> HR6, HR6HE		<b>G20-2000</b> Metal		<b>Denso</b> 10S15C, 10S15L, 10S17C, 10S20C, 10S20F, 10S20H	
<b>G13-2164</b> Metal		Front Head		<b>G20-2016</b> Metal	
Front Head		<b>Denso</b> 10PA15 Series, 10PA17 Series		Front Head (Late Models)	
<b>GM/Harrison</b> HD6, HT6, HU6		<b>G20-2001</b> Metal		<b>Denso</b> 10S15C, 10S15L, 10S17C, 10S20C, 10S20F, 10S20H	
<b>G13-2165</b> Metal		Rear Head		<b>Denso</b> 10S15C, 10S15L, 10S20H	
Rear Head		<b>Denso</b> 10PA15A, 10PA15C, 10PA15E, 10PA15L, 10PA15LC, 10PA15SC, 10PA15VL, 10PA17A, 10PA17C, 10PA17E, 10PA17H, 10PA17J, 10PA17K, 10PA17SC, 10PA17SH, 10PA17VL			
<b>GM/Harrison</b> HD6, HT6, HU6					

























## Gaskets

<b>G20-2017</b> Metal	Center Case (BMW Only)		<b>G20-2146</b> Metal	Cylinder		<b>G20-2165</b> Metal	Denso 5SE12C Front Head Gasket (Metal)	
Denso 10S15C, 10S15L, 10S17C, 10S20C, 10S20F, 10S20H			Denso 6SEU12, 6SEU12C, 6SEU14C			Denso 5SE12C		
<b>G20-2128</b> Metal	Front Head		<b>G20-2147</b> Metal	Front Head		<b>G20-2166</b> Metal	Denso 5SE12C Cylinder Gasket (Metal)	
Denso 10P13C, 10P15C			Denso 10S11C, 10S11P, 10S13C, 10S13P			Denso 5SE12C		
<b>G20-2134</b> Metal	Rear Head		<b>G20-2148</b> Metal	Rear Head		<b>G20-2167</b> Metal	Denso 5SE12C Rear Head Gasket (Metal)	
Denso 7SBU16C, 7SBU17C, 7SEU16, 7SEU17C			Denso 10S11C, 10S11P, 10S13C, 10S13P			Denso 5SE12C		
<b>G20-2135</b> Metal	Front Head		<b>G20-2149</b> Metal	Cylinder		<b>G20-2168</b> Metal	Denso 5SE12C Suction Port Gasket (Metal)	
Denso 7SB16C, 7SBU16C, 7SBU17C, 7SEU16, 7SEU17C			Denso 10S11C, 10S11P, 10S13C, 10S13P			Denso 5SE12C		
<b>G20-2136</b> Metal	Cylinder		<b>G20-2150</b> Metal	Center Case		<b>G20-2170</b> Metal	10SR Front Head Gasket	
Denso 7SBU16C, 7SBU17C, 7SEU16, 7SEU17C			Denso 10S13C, 10S13P			Denso 10SR15C, 10SR15C, 10SR17C		
<b>G20-2138</b> Metal	Cylinder		<b>G20-2154</b> Metal	Center Case		<b>G20-2171</b> Metal	10SR Rear Head Gasket	
Denso 6SEU16			Denso 10S11C, 10S11P			Denso 10SR15C, 10SR15C, 10SR17C		
<b>G20-2139</b> Metal	Rear Head		<b>G20-2160</b> Metal	Denso 5SE09C Front Head Gasket (Metal)		<b>G20-2172</b> Metal	10SR Front/Rear Cylinder Gasket	
Denso 6SEU16			Denso 5SE09C			Denso 10SR15C, 10SR15C, 10SR17C		
<b>G20-2140</b> Metal	Front Head		<b>G20-2161</b> Metal	Denso 5SE09C Cylinder Gasket (Metal)		<b>G20-2173</b> Metal	Denso 10SR / SRE Center Housing Gasket	
Denso 6SEU16			Denso 5SE09C			Denso 10SR15C, 10SR17C		
<b>G20-2144</b> Metal	Rear Head		<b>G20-2162</b> Metal	Denso 5SE09C Rear Head Gasket (Metal)		<b>G20-2174</b> Metal	Denso 10SRE Front Head Gasket	
Denso 6SEU12, 6SEU12C, 6SEU14C			Denso 5SE09C			Denso 10SRE Rear Head Gasket		
<b>G20-2145</b> Metal	Front Head		<b>G20-2163</b> Metal	Denso 5SE09C Suction Port Gasket (Metal)		<b>G20-2175</b> Metal	Denso 10SRE Rear Head Gasket	
Denso 6SEU12C, 6SEU14C			Denso 5SE09C					

## Gaskets

<b>G20-2176</b> Denso 10SRE Front / Rear Cylinder Gasket	Metal 	<b>G25-2167</b> Head Gasket (Late)	Metal 	<b>G25-2186</b> Cylinder	Metal 
<b>G25-2110</b> Cylinder - Rover/Jaguar	Metal 	<b>G25-2170</b> Sanden PXE13 Front Head Gasket (Metal)	Metal 	<b>G30-2115</b> Rear Metal Gasket	Metal 
<b>G25-2151</b> Head	Metal 	<b>G25-2171</b> Sanden PXE13 Cylinder Gasket (Metal)	Metal 	<b>G30-2116</b> Rear Metal Gasket	Metal 
<b>G25-2152</b> Cylinder	Metal 	<b>G25-2172</b> Sanden PXE13 Rear Head Gasket (Metal)	Metal 	<b>G30-2135</b> Front Head	Metal 
<b>G25-2161</b> Cylinder	Metal 	<b>G25-2176</b> Sanden PXE16 Front Head Gasket (Metal)	Metal 	<b>G30-2136</b> Cylinder	Metal 
<b>G25-2162</b> Head	Metal 	<b>G25-2177</b> Sanden PXE16 Cylinder Gasket (Metal)	Metal 	<b>G30-2137</b> Rear Head	Metal 
<b>G25-2163</b> Head Gasket (Early)	Metal 	<b>G25-2178</b> Sanden PXE16 Rear Head Gasket (Metal)	Metal 	<b>G30-2140</b> Front Head	Metal 
<b>G25-2164</b> Cylinder	Metal 	<b>G25-2180</b> Sanden SD7C16 Cylinder Gasket (Metal)	Metal 	<b>G30-2141</b> Rear Head	Metal 
<b>G25-2166</b> Cylinder	Metal 	<b>G25-2181</b> Sanden SD7C16 Rear Head Gasket (Metal)	Metal 	<b>G40-2151</b> Cylinder	Metal 
<b>G25-2185</b> Rear Head	Metal 	<b>G25-2185</b> Rear Head	Metal 	<b>G40-2152</b> Head	Metal 

## Gaskets

<b>G40-2161</b> Metal Head  Tecumseh HG1000, HG850	<b>G12-3101</b> Molded HNBR, Green Gasket - Ford Scroll (Large) 	<b>G20-3115</b> Molded HNBR, Green Manifold / Diffuser 
<b>G40-2171</b> Metal Head  York SC206, SC209	<b>Ford</b> LARGE SCROLL <b>G12-3102</b> Molded HNBR, Green HS15 Hyundai Suction / Discharge Manifold 	<b>Denso</b> 10P15 Series <b>G20-3116</b> Molded HNBR, Green Discharge Housing 
<b>G45-2103</b> Metal Front Head  Calsonic DKV14D Diesel Kiki DCV11A, DCV11D, DCV14A, DKV11A, DKV11D	<b>Visteon</b> HS15 <b>G13-3100</b> Molded HNBR, Green Rear Head Molded Gasket 	<b>Denso</b> 6SEU12C, 6SEU14C, 6SEU16, 7SB16C, 7SBU16C, 7SBU17C, 7SEU16, 7SEU17C <b>G20-3117</b> Molded HNBR, Green Manifold (Audi) 
<b>G45-2104</b> Metal Rear Head  Calsonic DKV14D Diesel Kiki DCV11A, DCV14A	<b>Delphi</b> CVC-165, CVC-185, CVC7P <b>G20-3106</b> Molded HNBR, Green Suction / Discharge Port 	<b>Denso</b> 10P17C <b>G25-3101</b> Molded HNBR, Green Discharge Port 
<b>G70-2100</b> Metal Zexel DCS17E Front Head Gasket (Metal)  Zexel DCS17E, DCS17IC	<b>Denso</b> 10PA15C, 10PA15E, 10PA15L, 10PA15LC, 10PA15SC, 10PA15VC, 10PA15VL, 10PA17 Series, 10PA20C, 10PA20H, 10PA20J, 10PA20SC, 10PA20SH, 10PA20VC <b>G20-3107</b> Molded HNBR, Green Intake Manifold 	<b>Sanden</b> PXV16 <b>G25-3102</b> Molded HNBR, Green Discharge Port 
<b>G70-2101</b> Metal Zexel DCS17E Cylinder Gasket (Metal)  Zexel DCS17E, DCS17IC	<b>Denso</b> 10P08E, 10P13C, 10P15C, 10P17C <b>G20-3109</b> Molded HNBR, Green High Temperature Sensor Manifold 	<b>Sanden</b> PXE16 <b>G25-3103</b> Molded HNBR, Green Discharge Port 
<b>G70-2102</b> Metal Zexel DCS17E Rear Head Gasket (Metal)  Zexel DCS17E, DCS17IC	<b>Denso</b> TV12 Series, TV14 Series <b>G20-3110</b> Molded HNBR, Green Suction / Discharge Port (10PA17C BMW) 	<b>Sanden</b> PXE13 <b>G30-3101</b> Molded HNBR, Green Center Case Molded 
<b>G20-3114</b> Molded HNBR, Black Manifold / Diffuser  Denso 10P15 Series	<b>Denso</b> 10PA17C <b>G20-3111</b> Molded HNBR, Green Suction / Discharge Port (10PA15C Mercedes) 	<b>Diesel Kiki</b> DKS13G (DUAL), DKS13G (SINGLE), DKS15G <b>G30-3102</b> Molded HNBR, Green Center Case 
<b>G12-3100</b> Molded HNBR, Green HS15 Suction / Discharge Port  Visteon HS15	<b>Denso</b> 10PA15C, 10PA15SC	<b>Diesel Kiki</b> DKS13S, DKS15S

## Gaskets

**G30-3103** Molded HNBR, Green

Center Case Molded



Center Case Molded

Diesel Kiki DKS16H(R12)

**G30-3104** Molded HNBR, Green

Center Case



Diesel Kiki DKS16H(R134A)

**G30-3105** Molded HNBR, Green

Center Case



Diesel Kiki DKS17S

**G30-3106** Molded HNBR, Green

Reed Plate (11A)



Diesel Kiki DCV11A, DCV11D, DKV11A, DKV11D

**G30-3108** Molded HNBR, Green

Molded Shape



Diesel Kiki DCV14J, DKV11G, DKV14G, DKV14J

**G45-3102** Molded HNBR, Green

Reed Plate (14A)



Calsonic DKV14D

Diesel Kiki DCV14A

**G45-3103** Molded HNBR, Green

Rear Molded



Calsonic DKV14D

Diesel Kiki DCV11A, DCV11D, DCV14A, DKV11A, DKV11D

**G45-3104** Molded HNBR, Green

Front Molded



Calsonic DKV14D

Diesel Kiki DCV11A, DCV11D, DCV14A, DKV11A, DKV11D

**G50-3101** Molded HNBR, Green

Suction / Discharge Manifold



Mats/Pan N1300AC4, NL1300AA4, NL1300AB4, NL1300AE4

**G50-3102** Molded HNBR, Green

Suction / Discharge Manifold



Mats/Pan S1150F3, S1150X3

**G50-3103** Molded HNBR, Green

Suction / Discharge Manifold



Mats/Pan SA1150AE4

**G50-3104** Molded HNBR, Green

Suction / Discharge Manifold



Mats/Pan N1301AB4, N1301AD4, N1301AE4

**G50-3105** Molded HNBR, Green

Manifold Molded Gasket



Mats/Pan H12A1AH4DX

**G55-3100** Molded HNBR, Green

Suction / Discharge Manifold



Mitsubishi MSC105CVS

**G55-3101** Molded HNBR, Green

Rear Control Housing



Mitsubishi MSC105CVS

**G55-3102** Molded HNBR, Green

Suction / Discharge Manifold



Mitsubishi MSC90, MSC90C

**G55-3103** Molded HNBR, Green

Control Body Gasket



Mitsubishi MSC130CVSG, MSC130CVSG2

**G70-3100** Molded HNBR, Green

Discharge Port



Zexel DCS17E, DCS17IC

**G95-3101** Molded HNBR, Green

Rotor Body



Behr WINGCELL

**G13-3200** Molded Neoprene

Destroyer Valve Plate



Seal - Destroyer Valve Plate

GM/Harrison V7 (DESTROKER)

**G45-3001** Molded Nitrile

Rotor Body



Nihon DKV14B

**G13-1102-100** Mylar

Front Flange (100 pack)



GM/Harrison A6

**K13-5101** Assorted Components

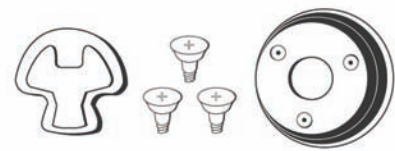

Includes: Clutch Dust Cover (1), Clutch Dust Cover Screws (3), Coil Gasket (Foam Rubber) (1)

GM/Harrison A6



## Gaskets

### K11-2001 Black Nitrile

Metal Gasket Kit

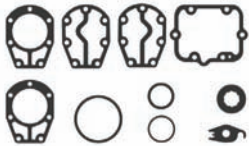

Includes: Suction Port Gasket (1), Discharge Port Gasket (1), Base Plate Gasket (1), Head Gasket (2), Cylinder gasket (2), Oil Pump O-Ring (1), Shaft Seal Seat O-Ring (1), Nose Plate O-Ring (1).

Chrysler RV2

### K11-2005 Black Nitrile

Metal Gasket Kit



Includes: Head Bolt Washer (6), Suction / Discharge Port Gasket (Metal) (2), Head Gasket (Metal) (2), Case Lathe Cut Seal (Center) (1), Case Lathe Cut Seal (Front and Rear) (2)

Chrysler A590

### K11-2010 Black Nitrile

Fiber Gasket Kit

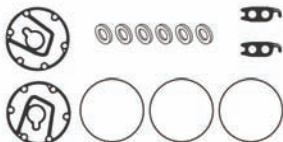

Includes: Head Bolt Washer (6), Suction / Discharge Port Gasket (Metal) (2), Head Gasket (Metal) (2), Case Lathe Cut Seal (3)

Chrysler C171

### K11-2015 Black Nitrile

Fiber Gasket Kit

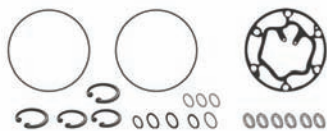

Includes: Retain Rings: Switch Port/Small Control Valve(2), Lip Seal(1), Long Control Valve(1); Cylinder Gasket(1); O-Rings: Case(2), Long Control Valve(3), PRV O-Ring(1), Short Control Valve(2), Lip Seal(1), Sw Port(1); Head Bolt Washer(6).

Chrysler 6C17

### K12-2005 Black Nitrile

Metal Gasket Kit



Includes: Head Bolt Washer (6), Head Gasket (Metal) (2), Case Lathe Cut Seal (3), Suction / Discharge Port O-Ring (4)

Ford FS6, FS6 CROSS MOUNT

### K12-2026 Black Nitrile

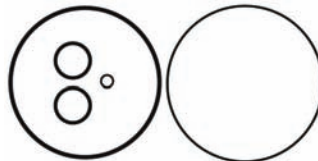

Includes: Rear Stationary Scroll O-Ring(1), Case O-Ring(1), Oil Drain Plug O-Ring(1), Switch Port O-Ring(2),

Ford SCROLL

### K13-2002 Black Nitrile

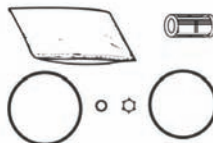

Includes: Desiccant Bag (R134a Compatible) (1), Pickup Tube Screen (1), Pickup Tube Retainer (1), Housing to Receiver Shell Lathe Cut (Upper) (1), Condenser Line O-Ring / Pickup Tube O-Ring (1), Housing to Receiver Shell O-Ring (Lower) (1)

GM/Harrison VIR

### K13-2005 Black Nitrile

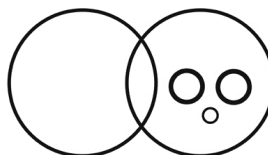

Includes: Case O-Ring(2), HPRV O-Ring(1), Suction / Discharge Port O-Ring (2)

GM/Harrison A6

### K13-2010 Black Nitrile

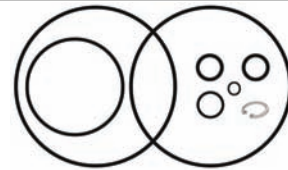

Includes: Case O-Ring (2), Switch Port Retaining Ring (1), Nose Piece Lathe Cut Seal (1), Switch Port O-Ring (1), Suction / Discharge Port O-Ring (2), Pressure Relief Valve O-Ring (1).

GM/Harrison R4

### K13-2015 Black Nitrile

Metal Gasket Kit

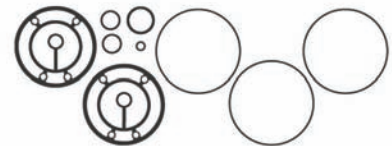

Includes: Head Gasket (6.9 mm Bolt Holes) (2), Switch Port O-Ring (1), Case O-Ring (3), Suction / Discharge Port O-Ring (2), Discharge Crossover O-Ring (1)

GM/Harrison DA6, HR6

### K13-2016 Black Nitrile

Metal Gasket Kit

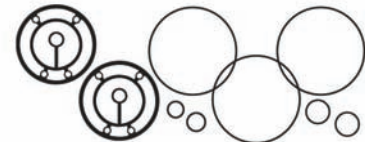

Includes: Head Gasket (Metal) (7.8 mm Bolt Holes) (2), Switch Port O-Ring (1), Case O-Ring (3), Suction / Discharge Port O-Ring (2), Discharge Crossover O-Ring (1)

GM/Harrison HR6, HR6HE

### K13-2017 Black Nitrile

Metal Gasket Kit



Includes: Head Gasket - Front(Metal) (1), Head Gasket - Rear(Metal) (1), Switch Port O-Ring (1), Case O-Ring (3), Discharge Crossover O-Ring (1)

GM/Harrison HT6, HU6

## Gaskets

**K13-2018** **Black Nitrile**

Metal Gasket Kit

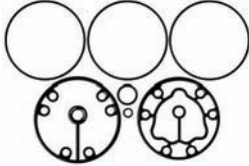

Includes: Head Gasket - Front(Metal) (1), Head Gasket - Rear(Metal) (1), Switch Port O-Ring (1), Case O-Ring (3), Discharge Crossover O-Ring (1)

**GM/Harrison** HD6, HT6

**K13-2020** **Black Nitrile**

Metal Gasket Kit

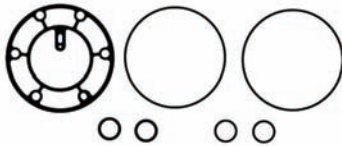

Includes: Head Gasket (Metal) (6.8 mm x 7.7 mm Oval Bolt Hole) (1), Switch Port O-Ring (2), Case O-Ring (2), Suction / Discharge Port O-Ring (2)

**GM/Harrison** V5, V5 (DESTROKER)

**K13-2023** **Black Nitrile**

V5 Metal Gasket Kit 1993 and Later

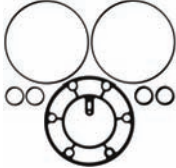

Includes: Valve Plate Gaskets -1993 and Later - Metal (1), Case O-ring (2), Suction / Discharge O-ring (2),. Switch Port O-ring (2)

**GM/Harrison** V5

**K13-2029** **Black Nitrile**

Fiber Gasket Kit

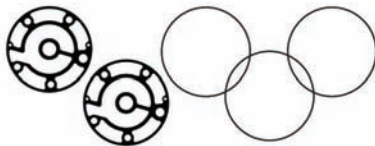

Includes: Head Gasket (2), Case O-Rings (3)

**Delphi** SP10

**K13-2030** **Black Nitrile**

Metal Gasket Kit

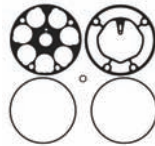

Includes: Front Head Gasket (1), Rear Head Gasket (1), Case O-Ring (2), Pressure Relief Valve O-Ring (1).

**GM/Harrison** V7

**K14-2000** **Black Nitrile**

O-Ring Kit

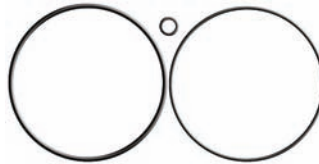

Includes: Front Case O-Ring(1), Rear Case O-Ring(1), PRV O-Ring(1)

**Visteon** HS090L, HS090R, HS110R

**K20-2001** **Black Nitrile**

Fiber Gasket Kit

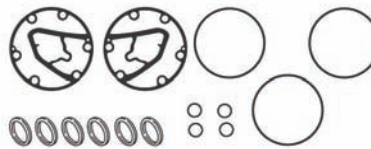

Includes: Head Bolt Washer (6), Head Gasket (Fiber) (2), Case O-Ring (3), Suction / Discharge Port O-Ring (4)

**Denso** 6P127A, 6P127B, 6P148, 6P148A, 6P148C

**K20-2002** **Black Nitrile**

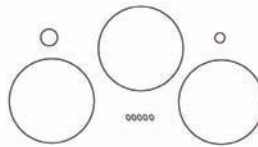

Includes: Head Bolt Washer (5), Metal Shaft Seal Seat O-Ring (1), Carbon Shaft Seal O-Ring (1), Case O-Ring (3)

**Denso** 10P17 Series

**K20-2005** **Black Nitrile**

Metal Gasket Kit

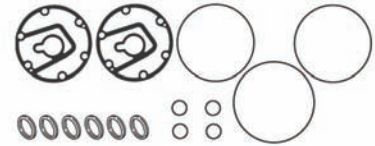

Includes: Head Bolt Washer (6), Head Gasket (Metal) (2), Case O-Ring (Front & Rear) (2), Case O-Ring (Center) (1), Suction / Discharge Port O-Ring (4)

**Denso** 6E171

**K20-2015** **Black Nitrile**

Metal Gasket Kit

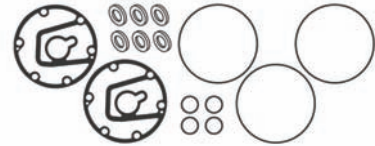

Includes: Head Bolt Washer (6), Head Gasket (Metal) (2), Case O-Ring (3), Suction/Discharge Port O-Ring (4).

**Denso** 6P134

**K20-2025** **Black Nitrile**

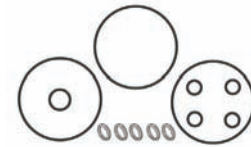

Includes: Head Bolt Washer (5), Case O-Ring (3), Metal Shaft Seal Seat O-Ring (Pre 1992)/Lip Seal O-Ring (1), Suction / Discharge Port O-Ring (4)

**Denso** 10P08E

**K20-2030** **Black Nitrile**



Includes: Head Bolt Washer (5), Case O-Ring (3), Metal Shaft Seal Seat (1), Suction/Discharge Port O-Ring (4).

**Denso** 10P13 Series, 10P15 Series

## Gaskets

### K20-2045 Black Nitrile

10PA15/10PA17 O-ring Kit - Nitrile W/O gaskets

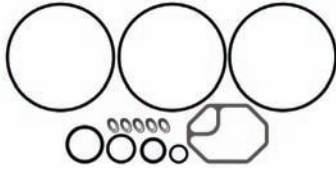

Includes: Head Bolt Washer (5), Suction / Discharge Port Gasket - HNBR (1), Bottom/Side Switch O-Ring (1), Metal Shaft Seal Seat O-Ring (1), Case O-Ring (3), Lip Seal O-Ring (1), Switch Port O-Ring (1)

Denso 10PA15A

### K20-2046 Black Nitrile

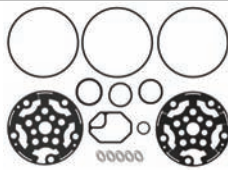

Includes: Head Gaskets (2), Head Bolt Washer (5), Suction / Discharge Port Gasket - HNBR (1), Bottom/Side Switch O-Ring (1), Metal Shaft Seal Seat O-Ring (1), Case O-Ring (3), Lip Seal O-Ring (1), Switch Port O-Ring (1)

Denso 10PA15A, 10PA15C, 10PA15E, 10PA15L, 10PA15LC, 10PA15SC, 10PA17A, 10PA17C, 10PA17E, 10PA17H, 10PA17J, 10PA17K, 10PA17SH

### K20-2061 Black Nitrile

Metal Gasket Kit



Includes: Center Case Gasket (1), Cylinder Gasket (2), Rear Head Gasket (1), Front Head Gasket (1), Body Sensor Port O-Ring (1), Pressure Relief Valve O-Ring (1), Pressure Sensor O-Ring (1).

Denso 10S15C, 10S17C, 10S20C, 10S20F, 10S20H

### K20-2067 Black Nitrile

Metal Gasket Kit (Late)

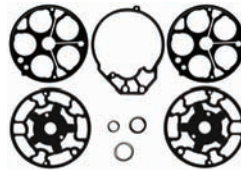

Includes: Center Case Gasket (1), Cylinder Gasket (2), Rear Head Gasket (1), Front Head Gasket (1), Body Sensor Port O-Ring (1), Pressure Relief Valve O-Ring (1), Pressure Sensor O-Ring (1).

Denso 10S15C, 10S15L, 10S17C

### K25-2010 Black Nitrile

Metal Gasket Kit

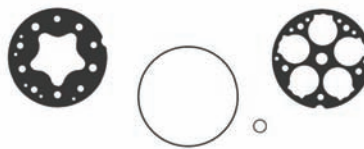

Includes: Head Gasket (Metal) (1), Cylinder Gasket (1), Case Lathe Cut Seal (1), Oil Plug O-Ring / Service Port O-Ring (Universal) (1)

Sanden SD505, SD507, SD507A2, SD508, SD510, SD5H09, SD5H11, SD5H13

### K25-2015 Black Nitrile

Metal Gasket Kit

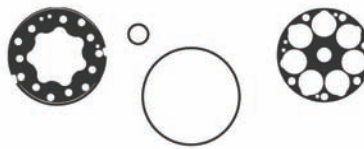

Includes: Case Lathe Cut Seal (1), Cylinder Gasket (Metal) (1), Head Gasket (Metal) (1), Oil Plug O-Ring (1)

Sanden SD708, SD709, SD7H15

### K25-2020 Black Nitrile

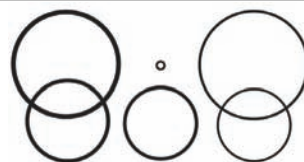

Includes: Nose Piece O-Ring - Early Models (1), Orbiting Rotor Body O-Ring (1), Nose Piece O-Ring - Mid Models (1), Nose Piece O-Ring - Late Model (1), Scroll to Rear Housing O-Ring (1), Oil Drain Bolt O-Ring (1)

Sanden TR70

### K25-2026 Black Nitrile

Fiber Gasket Kit

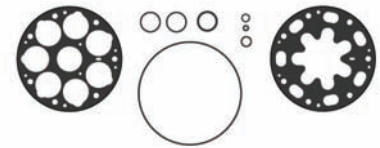

Includes: Oil Plug O-Ring (1), Head Gasket (1), Cylinder Gasket (1), Case O-Ring (1), Internal Orifice Tube O-Ring (1), Pressure Relief Valve O-Ring (1), Suction / Discharge O-Ring (2), Pressure Regulator O-Ring (1)

Sanden SD7V16

### K25-2032 Black Nitrile

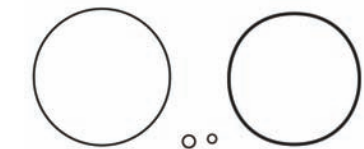

Includes: Rear Stationary Scroll O-Ring (1), Front Case O-Ring (1), Pressure Relief Valve O-Ring (1), Oil Drain Plug O-Ring (1).

Sanden TR105, TR105VS, TRF105, TRS105

### K30-2005 Black Nitrile

Fiber Gasket Kit

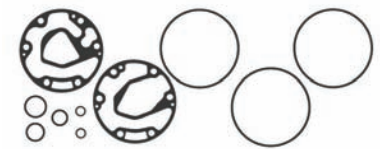

Includes: Front Head Gasket (1), Rear Head Gasket (1), Oil Fill/Drain Plug O-Ring (2), Case O-Ring (3), Discharge Port O-Ring (1), Suction Port O-Ring (1), Metal Shaft Seal Seat O-Ring (1)

Diesel Kiki DKS15BH

### K30-2012 Black Nitrile

Fiber Gasket Kit

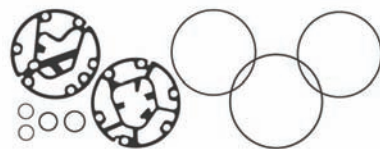

Includes: Front Head Gasket (1), Rear Head Gasket (1), Case O-Ring (Center) (1), Case O-Ring (Front and Rear) (2), Oil Plug O-Ring (1), Pressure Relief Valve O-Ring (1), Discharge Port O-Ring (1), Suction Port O-Ring (1)

Diesel Kiki DKS15CH

## Gaskets

**K35-2005** Black Nitrile

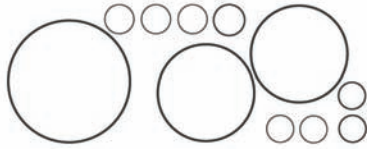

Includes: Metal Seal Seat O-Ring (1), Internal / Front / Rear Rotor O-Ring (3), Internal Suction O-Ring (2), Center Rotor O-Ring (2), Nose O-Ring (1), Suction / Discharge O-Ring (2)

Seiko-Seiki SS170PSS

**K35-2007** Black Nitrile

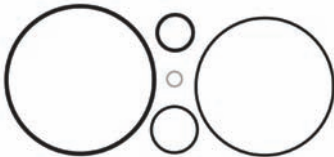

Includes: Rear Internal Screen Body O-Ring (1), Rear Case O-Ring (1), Front Case O-Ring(1), Pressure Relief Valve O-Ring (1), Lip Seal O-Ring (1)

Seiko-Seiki SS121DN1, SS121DN2, SS121DV2

**K35-6001** Black Nitrile

O-Ring Kit



Includes: Low Side Cap 1/4" Fitting (2), Shipping Pad (2), Shipping Plate (1), Shipping Plate Bolt (1), Head Bolt Washer (4), Clutch Shim (3), Shaft Seal Seat O-Ring (1), Internal Rotor O-Ring (3), Internal Suction O-Ring (2), Center Case O-Ring (1), Nose

Seiko-Seiki SS170PSS

**K40-2010** Black Nitrile

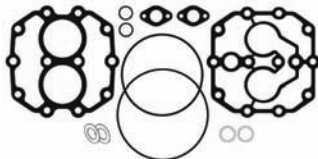

Includes: Oil Plug Washer (Copper) (2), Service Valve Gasket (2), Cylinder Gasket (1), Head Gasket - Metal (1), Base Plate Lathe Cut Seal (1), Rear Bearing Plate Lathe Cut Seal (1), Rotolock Service Valve Seal (Teflon) (2), Tube-O Valve O-Ring (2).

Tecumseh HG1000, HG850

**K40-2015** Black Nitrile

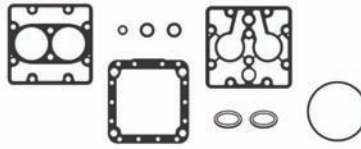

Includes: Cylinder Gasket (1), Base Plate Gasket (1), Head Gasket - Metal (1), Tube-O Valve Lathe Cut Seal (2), Rotolock Service Valve Seal (Teflon) (2), Oil Plug O-Ring (1), Rear Bearing Plate O-Ring (1).

York SC206, SC209

**K40-2021** Black Nitrile

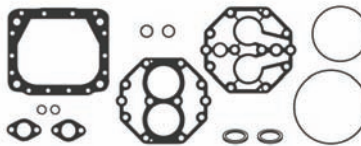

Includes: Gaskets: Service Valve(2), Base Plate(1), Cylinder-Metal (1), Head-Metal (1); Seal Plate Lathe Cut Seal (5 Bolt)(1); Rotolock Service Valve/Adapter Seal (Teflon)(2); O-Rings: Oil Plug(2), Tube O Valve/Rotolock Adapter(2), Rear Bearing Plate(1).

York 206, 209, 210

**K45-2001** Black Nitrile

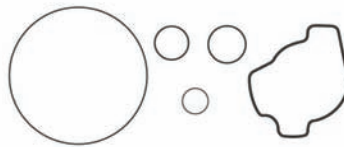

Includes: Rotor Body Gasket (1), Valve Body O-Ring (Outer) (1), Carbon Shaft Seal O-Ring (1), Metal Shaft Seal Seat O-Ring (1), Case O-Ring (1).

Nihon DKV14B

**K45-2002** Black Nitrile

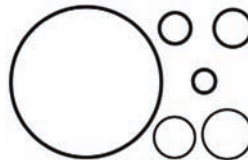

Includes: Large Seat O-Ring (1), Rotor Body Housing O-Ring (Front) (1), Rotor Body Housing O-Ring (Rear) (1), Carbon Shaft Seal O-Ring (1), Small Seat O-Ring (1), Case O-Ring (1)

Nihon DKV14C

**K45-2005** Black Nitrile

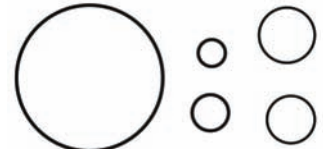

Includes: Metal Shaft Seal Seat O-Ring (1), Carbon Seal Head O-Ring (1), Rear Rotor Body O-Ring (1), Rear Rotor Body O-Ring (1), Case O-Ring (1)

Nihon NVR140S

**K50-2002** Black Nitrile

Fiber Gasket Kit



Includes: Gaskets: Head (1), Manifold (1); Teflon Rotor Ring Seal (1); O-Rings: Case (2), Manifold Switch (1), Suction Port (1), Front Head Switch (1), Carbon Seal (1) Metal Shaft Seal Seat (1), Suction/Discharge Seal (1).

Mats/Pan N1300AC4, NL1300AA4, NL1300AB4, NL1300AE4

**K55-2001** Black Nitrile

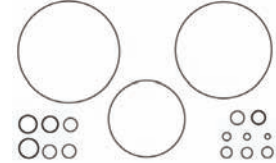

Includes: O-Rings: Front Scroll Housing (1), Control Valve (Inner) (1), Control Valve (Center) (1), Control Valve (Outer) (1), Nose Plate (1), Rear Housing Body (1), Sensor (1), Metal Shaft Seal Seat (1), Case (2), Rear Housing (3), Head Bolt (Rear) (4).

Mitsubishi FX105V

**K55-2007** Black Nitrile

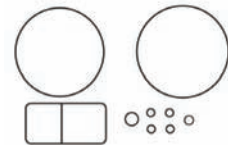

Includes: Suction / Discharge Housing Gasket (1), Pressure Release Valve O-Ring (1), Rear Case O-Ring (1), Front Nose Case O-Ring (1), Case Bolt O-Ring (4), Temperature Sensor O-Ring (1)

Mitsubishi MSC90, MSC90C

## Gaskets

**K60-2005** **Black Nitrile**

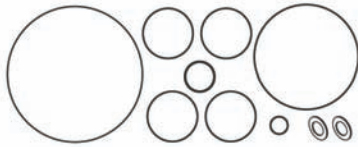

Includes: Clutch Shim (2), Carbon Shaft Seal O-Ring (1), Head Plate O-Ring (4), Case O-Ring (Inner) (1), Case O-Ring (Outer) (1), Metal Shaft Seat O-Ring (1)

**Keihin** 150L

**K60-2010** **Black Nitrile**

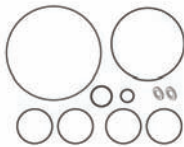

Includes: Clutch Shim (2), Carbon Shaft Seal O-Ring (1), Head Plate O-Ring (4), Case O-Ring (Inner) (1), Case O-Ring (Outer) (1), Metal Shaft Seat O-Ring (1)

**Keihin** 150R

**K65-2000** **Black Nitrile**

Fiber Gasket Kit



Includes: Case Gasket (1), Case O-Ring (1), Crossover O-Ring (2), Inner Valve Plate O-Ring (2), Outer Valve Plate O-Ring (2)

**Hitachi** MJS170

**K65-2001** **Black Nitrile**

Fiber Gasket Kit

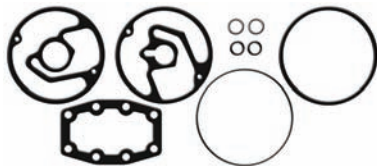

Includes: Front Case Gasket (1), Front Head Gasket (1), Rear Head Gasket (1), Side Plate Gasket (1), Crossover O-Ring (2), Case O-Ring (1), Vibration Damper O-Ring (2)

**Hitachi** A5000

**K65-2005** **Black Nitrile**

Fiber Gasket Kit (31.9mm Bore)

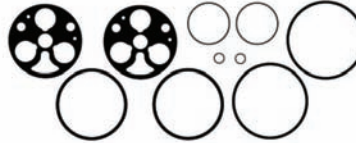

Includes: Case Gasket (1), Cylinder Gasket (2), Outer Valve Plate O-Ring (2), Crossover O-Ring(2), Inner Plate O-Ring (2), Rear Head O-Ring (1)

**Hitachi** MJ110

**K65-2011** **Black Nitrile**

Fiber Gasket Kit (37.0mm Bore)



Includes: Case Gasket (1), Cylinder Gasket (2), Outer Valve Plate O-Ring (2), Crossover O-Ring (1), Inner Valve Plate O-Ring (2), Rear Head O-Ring (1)

**Hitachi** MJ110, MJ123

**K65-2015** **Black Nitrile**

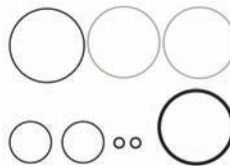

Includes: Case Gasket (1), Outer Valve Plate O-Ring (2), Crossover O-Ring (2), Inner Valve Plate O-Ring (2), Case O-Ring (1)

**Hitachi** MJ167, MJS130

**K65-2020** **Black Nitrile**

Fiber Gasket Kit

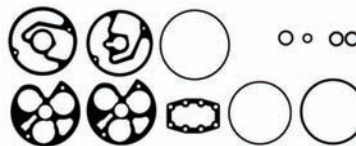

Includes: Case Gasket (2), Front Head Gasket (1), Rear Head Gasket (1), Cylinder Gasket (2), Side Plate Gasket (1), Pickup Tube O-Ring (1), Rear Head O-Ring (1), Crossover O-Ring (2), Suction Port O-Ring (1).

**Hitachi** SWP123, SWP167

**K75-2003** **Black Nitrile**

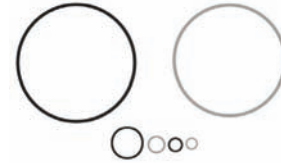

Includes: Front Case O-Ring (1), Rear Discharge Plate O-Ring (1), Rear Case O-Ring (1), Discharge Port O-Ring (1), Suction Port O-Ring (1), PRV O-Ring (1).

**Calsonic** CR14

**K95-2001** **Black Nitrile**

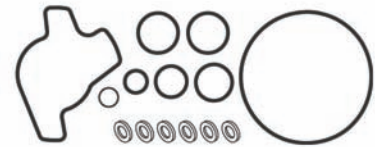

Includes: Head Bolt Washer (6), Rotor Body Gasket (1), Metal Shaft Seal O-Ring (1), Case O-Ring (1), Rotor O-Ring (2), Internal Head O-Ring (1), Carbon Shaft Seal O-Ring (1), Suction Port O-Ring (1).

**Behr** WINGCELL

**K95-2005** **Black Nitrile**

Fiber Gasket Kit

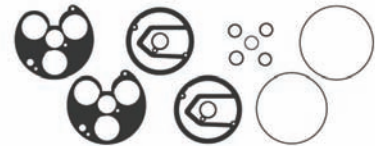

Includes: Cylinder Gasket (2), Head Gasket (2), Metal Shaft Seal O-Ring (1), Crossover O-Ring (1), Case O-Ring (2), Oil Plug O-Ring (1), Carbon Shaft Seal O-Ring (1), Oil Pickup Tube O-Ring (1)

**Bosch** AXIAL

**K95-6001** **Black Nitrile**

Rebuilder Kit



Includes: Shipping Pad (1), Shipping Plate(1), Suction Cap(1), Discharge Cap(Flare)(1), Head Bolt Washer(6), Rotor Body Gasket(1), Metal Shaft Seal O-Ring(1), Case O-Ring(1), Rotor O-Ring(2), Internal Head O-Ring(1), Carbon Shaft Seal O-Ring(1).

**Behr** WINGCELL

## Gaskets

### K11-2115 Green HNBR

Fiber Gasket Kit

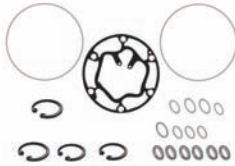

Includes: Retain Rings: Switch Port/Small Control Valve(2), Lip Seal(1), Long Control Valve(1); Cylinder Gasket(1); O-Rings: Case(2), Long Control Valve(3), PRV O-Ring(1), Short Control Valve(2), Lip Seal(1), Sw Port(1); Head Bolt Washer(6).

**Chrysler** 6C17

### K11-2116 Green HNBR

Metal Suction Gasket Kit



Includes: Suction Gasket (1), Suction O-Ring (1).

**Denso** 10S15C, 10S15L, 10S17C, 10S20C, 10S20F

### K11-2117 Green HNBR

Metal Discharge Gasket Kit



Includes: Discharge Gasket (1), Discharge O-Ring (1).

**Denso** 10S15C, 10S15L, 10S17C, 10S20C, 10S20F

### K11-2118 Green HNBR

Metal Suction / Discharge Gasket Kit



Includes: Discharge Gasket (1), Discharge O-Ring (1), Suction Gasket (1), Suction O-Ring (1).

**Denso** 10S15C, 10S15L, 10S17C, 10S20C, 10S20F

### K11-2119 Green HNBR

Metal Suction Gasket Kit (Jeep Only)



Includes: Suction Gasket (1), Suction O-Ring (1).

**Denso** 10S15C, 10S15L, 10S17C, 10S20C, 10S20F

### K12-2105 Green HNBR

Metal Gasket Kit

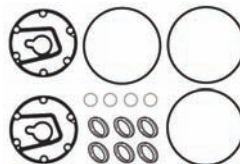

Includes: Head Bolt Washer (6), Head Gasket (Metal) (2), Case Lathe Cut Seal (3), Suction / Discharge Port O-Ring (4)

**Ford** FS6, FS6 CROSS MOUNT

### K12-2110 Green HNBR

Metal Gasket Kit (Early)

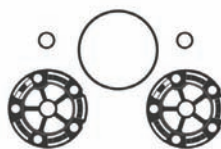

Includes: Head Gasket (Early) (2), Case O-Ring (1), Suction / Discharge Port O-Ring (2)

**Ford** FX15

### K12-2115 Green HNBR

Metal Gasket Kit (Mid)

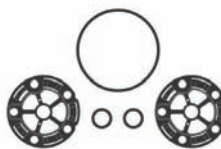

Includes: Head Gasket (Mid) (2), Case O-Ring (1), Suction / Discharge Port O-Ring (2)

**Ford** FX15

### K12-2120 Green HNBR

Metal Gasket Kit (Late)



Includes: Head Gasket (Late) (2), Case O-Ring (1), Suction / Discharge Port O-Ring (2)

**Ford** FX15

### K12-2125 Green HNBR

Metal Gasket Kit



Includes: Head Gasket (Mid) (2), Case O-Ring (1), Suction / Discharge Port O-Ring (2)

**Ford** FS10

### K12-2152 Green HNBR

Visteon VS16 Metal Gasket Kit

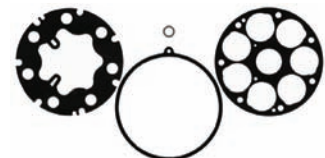

Includes: Front Head Gasket(1), Cylinder Gasket(1), Rear Head Gasket(1), PRV O-Ring(1)

**Visteon** VS16

### K13-2103 Green HNBR



Includes: Valve Core - Low Pressure (1), Desiccant Bag (R134a Compatible) (1), Sightglass (1), Sightglass Gasket (1), Pick-up Tube Screen (1), Cap - 1/4" Low Side (1), Retaining Ring - Pickup Tube (1), Housing to Receiver Shell Lathe Cut Seal (Upper) (1),

**GM/Harrison** VIR

## Gaskets

**K13-2105** Green HNBR

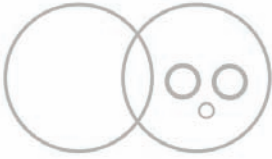

Includes: Case O-Ring(2), HPRV O-Ring(1), Suction / Discharge Port O-Ring (2)

GM/Harrison A6

**K13-2110** Green HNBR

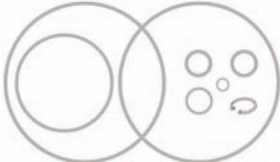

Includes: Case O-Ring (2), Switch Port Retaining Ring (1), Nose Piece Lathe Cut Seal (1), Switch Port O-Ring (1), Suction / Discharge Port O-Ring (2), Pressure Relief Valve O-Ring (1).

GM/Harrison R4

**K13-2115** Green HNBR

Metal Gasket Kit

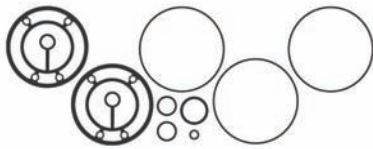

Includes: Head Gasket (Metal) (6.9 mm Bolt Holes) (2), Switch Port O-Ring (1), Case O-Ring (3), Suction / Discharge Port O-Ring (2), Discharge Crossover O-Ring (1)

GM/Harrison DA6, HR6

**K13-2116** Green HNBR

Metal Gasket Kit

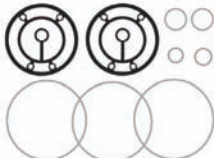

Includes: Head Gasket (Metal) (7.8 mm Bolt Holes) (2), Switch Port O-Ring (1), Case O-Ring (3), Suction / Discharge Port O-Ring (2), Discharge Crossover O-Ring (1)

GM/Harrison HR6, HR6HE

**K13-2117** Green HNBR

Metal Gasket Kit



Includes: Head Gasket - Front(Metal) (1), Head Gasket - Rear(Metal) (1), Switch Port O-Ring (1), Case O-Ring (3), Discharge Crossover O-Ring (1)

GM/Harrison HT6, HU6

**K13-2118** Green HNBR

GM HU6 Gasket Kit

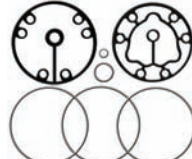

Includes: Front Head Gasket(1), Rear Head Gasket(1), Case O-Rings(3), PRV O-Ring(1), Switch Port O-Ring(1)

GM/Harrison HD6, HT6

**K13-2120** Green HNBR

Metal Gasket Kit

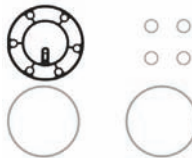

Includes: Head Gasket (Metal) (6.8 mm x 7.7 mm Oval Bolt Hole) (1), Switch Port O-Ring (2), Case O-Ring (2), Suction / Discharge Port O-Ring (2)

GM/Harrison V5, V5 (DESTROKER)

**K13-2121** Green HNBR

Metal Gasket Kit



Includes: Head Gasket (Metal) (8.0 mm x 8.3 mm Oval Bolt Hole) (1), Switch Port O-Ring (2), Case O-Ring (2), Suction / Discharge Port O-Ring (2)

GM/Harrison V5, V5 (DESTROKER)

**K13-2128** Green HNBR

Fiber Gasket Kit

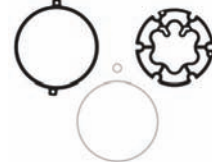

Includes: Front Head Gasket (1), Rear Head Gasket (1), Case O-Ring (1), High Pressure Relief Valve O-Ring (1)

Delphi CVC-125, CVC-135, CVC-135E, CVC6

**K13-2129** Green HNBR

Fiber Gasket Kit

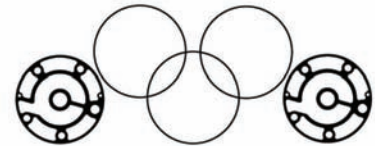

Includes: Head Gasket (2), Case O-Rings (3)

Delphi SP10

**K13-2130** Green HNBR

Metal Gasket Kit

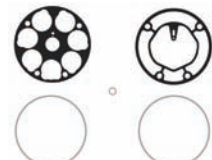

Includes: Cylinder Gasket(Metal) (1), Head Gasket(Metal) (1), Front & Rear Case O-Rings (2), High pressure Relief Valve O-Rings (1).

GM/Harrison V7

**K13-2133** Green HNBR

Delphi CVC135E Metal Gasket Kit

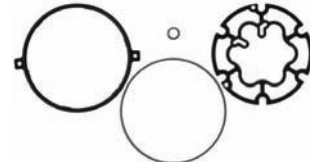

Includes: Front Head Gasket(1), Rear Head Gasket(1), Case O-Rings(3), PRV O-Ring(1)

Delphi CVC-135E

## Gaskets

### K20-2101 Green HNBR

Fiber Gasket Kit

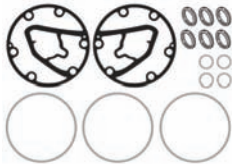

Includes: Head Bolt Washer (6), Head Gasket (Fiber) (2), Case O-Ring (3), Suction / Discharge Port O-Ring (4)

Denso 6P127A, 6P127B, 6P148, 6P148A, 6P148C

### K20-2102 Green HNBR

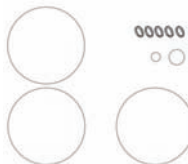

Includes: Head Bolt Washer (5), Metal Shaft Seal Seat O-Ring (1), Carbon Shaft Seal O-Ring (1), Case O-Ring (3)

Denso 10P17 Series

### K20-2115 Green HNBR

Metal Gasket Kit

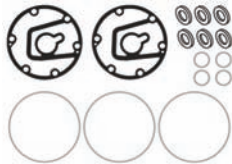

Includes: Head Bolt Washer (6), Head Gasket (2), Case O-Ring (3), Suction / Discharge Port O-Ring (4)

Denso 6P134

### K20-2120 Green HNBR

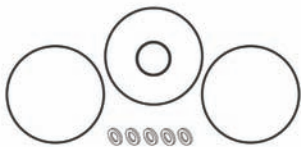

Includes: Head Bolt Washer (5), Case O-Ring (3), Lip Seal O-Ring (1)

Denso 10PA20C, 10PA20H, 10PA20J, 10PA20SC, 10PA20SH

### K20-2130 Green HNBR

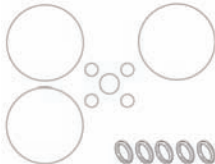

Includes: Head Bolt Washer (5), Case O-Ring (3), Metal Shaft Seal Seat O-Ring (Pre 1992)/Lip Seal O-Ring (1), Suction / Discharge Port O-Ring (4)

Denso 10P13 Series, 10P15 Series

### K20-2131 Green HNBR

Metal Gasket Kit



Includes: Cylinder Gasket (1), Valve Plate Gasket (1), Front Head Gasket (1), Discharge Manifold Gasket, Pressure Relief Valve O-Ring (1).

Denso 7SBU16C, 7SEU16, 7SEU17C

### K20-2132 Green HNBR

Metal Gasket Kit

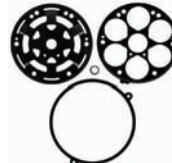

Includes: Cylinder Gasket (1), Valve Plate Gasket (1), Front Head Gasket (1), Pressure Relief Valve O-Ring (1).

Denso 6SEU12C, 6SEU14C

### K20-2140 Green HNBR

Gasket Kit

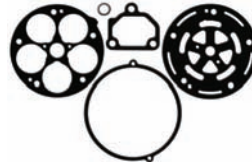

Includes: Front Head Gasket(1), Cylinder Gasket(1), Rear Head Gasket(1), and Suction Cavity Gasket(1)

Denso 5SE09C

### K20-2143 Green HNBR

Gasket Kit

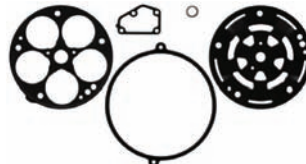

Includes: Front Head Gasket(1), Cylinder Gasket(1), Rear Head Gasket(1), and Suction Cavity Gasket(1)

Denso 5SE12C

### K20-2146 Green HNBR

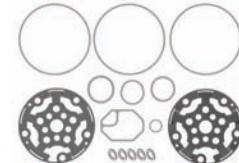

Includes: Head Gaskets (2), Head Bolt Washer (5), Suction / Discharge Port Gasket - HNBR (1), Bottom/Side Switch O-Ring (1), Metal Shaft Seal Seat O-Ring (1), Case O-Ring (3), Lip Seal O-Ring (1), Switch Port O-Ring (1)

Denso 10PA15A, 10PA15C, 10PA15E, 10PA15L, 10PA15LC, 10PA15SC, 10PA17A, 10PA17C, 10PA17E, 10PA17H, 10PA17J, 10PA17K, 10PA17SH

### K20-2150 Green HNBR

Fiber Gasket Kit

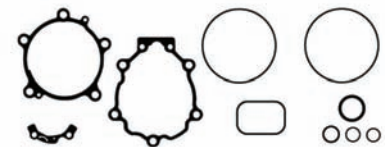

Includes: Gaskets: Front Head(1), Rear Head(1), Rotor Pressure Bypass(TV14C)(1), Hi Temp Sensor Manifold(1); O-Rings: Metal Seat(1), Case(2), Sensor(1), Hi Temp Block(1), Carbon Shaft Seal(1).

Denso TV12C(R12), TV14C

### K20-2151 Green HNBR

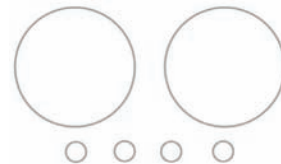

Includes: Metal Shaft Seal Seat O-Ring (1), Carbon Shaft Seal O-Ring (1), Case O-Ring (2), Sensor Block O-Ring (Small) (1), Sensor Block O-Ring (Large) (1)

Denso TV10 Series

### K20-2152 Green HNBR

Fiber Gasket Kit

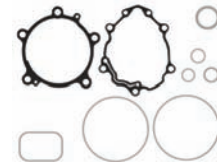

Includes: Gaskets: Front Head(1), Rear Head(1), Hi Temp Sensor Manifold(1); O-Rings: R134a Adapter (1), Case(2), Hi Temp Block(1), Pressure Relief Valve(1), Temperature Switch Dust Shield(1).

Denso TV12C(R134)



## Gaskets

### K20-2153 Green HNBR

Fiber Gasket Kit

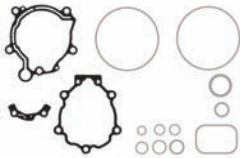

Includes: Gaskets: Rear Head(1), Front Head(1), Rotor PSI By-Pass(1), Manifold(1); O-Rings: Shaft Seal Seat(1), Large Crossover(1), Case(2), Sensor(1), Temp Block(1), Carbon Shaft Seal(1), Oil Bleed Valve(1), Small Crossover(1), Temp Sw Dust Shield(1).

Denso TV12EC(R12), TV14EC

### K20-2154 Green HNBR

Fiber Gasket Kit



Includes: Gaskets: Rear Head(1), Front Head(1), Manifold(1); O-Rings: Large Crossover(1), Case(2), Temp Block(1), Oil Bleed Valve(1), Temp Sw Dust Shield(1), R134a Adapter(1), Pressure Relief Valve(1).

Denso TV12SC(R134), TV14SC

### K20-2156 Green HNBR

Fiber Gasket Kit



Includes: Front Head Gasket (1), Rear Head Gasket (1), Cylinder Gasket (1), Discharge Housing Gasket (1), Control Valve O-Ring (Inner)(1), Control Valve O-Ring (Outer)(1), Control Valve O-Ring (Intermediate) (1).

Denso 7SB16C

### K20-2158 Green HNBR

Metal Gasket Kit (Mercedes)

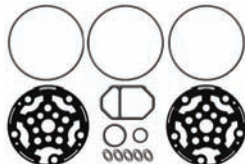

Includes: Front Head Gasket (1), Rear Head Gasket (1), Suction/Discharge Port Gasket (1), Head Bolt Washer (5), Case O-Ring (3), Lip Seal O-Ring (1), Body Sensor O-Ring (1).

Denso 10PA15C

### K20-2159 Green HNBR

Metal Gasket Kit (BMW)

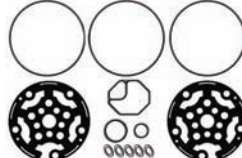

Includes: Front Head Gasket (1), Rear Head Gasket (1), Suction/Discharge Port Gasket (1), Head Bolt Washer (5), Case O-Ring (3), Lip Seal O-Ring (1), Body Sensor O-Ring (1).

Denso 10PA17C

### K20-2160 Green HNBR

Metal Gasket Kit

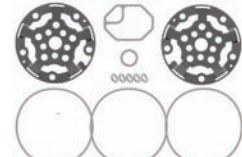

Includes: Front Head Gasket (1), Rear Head Gasket (1), Suction/Discharge Port Gasket (1), Head Bolt Washer (5), Case O-Ring (3), Lip Seal O-Ring (1).

Denso 10PA20C, 10PA20H, 10PA20J

### K20-2161 Green HNBR

Metal Gasket Kit



Includes: Center Case Gasket (1), Cylinder Gasket (2), Rear Head Gasket (1), Front Head Gasket (1), Body Sensor Port O-Ring (1), Pressure Relief Valve O-Ring (1), Pressure Sensor O-Ring (1).

Denso 10S15C, 10S15L, 10S17C, 10S20C, 10S20F, 10S20H

### K20-2167 Green HNBR

Metal Gasket Kit (Late)

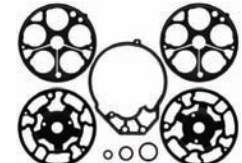

Includes: Center Case Gasket (1), Cylinder Gasket (2), Rear Head Gasket (1), Front Head Gasket (1), Body Sensor Port O-Ring (1), Pressure Relief Valve O-Ring (1), Pressure Sensor O-Ring (1).

Denso 10S15C, 10S15L, 10S17C, 10S20C, 10S20F, 10S20H

### K20-2168 Green HNBR

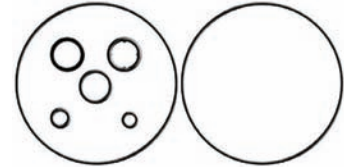

Control Valve O-Ring(Outer)(1), Control Valve O-Ring(Inner)(1), Control Valve Set O-Ring(1), Suction/Discharge O-Ring(2), Case O-Ring(2).

Denso 6CA17C

### K20-2169 Green HNBR

Metal Gasket Kit

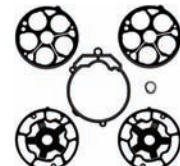

Includes: Cylinder Gasket (1), Front Valve Plate Gasket (1), Rear Valve Plate Gasket (1), Center Gasket (1), High Pressure Relief Valve O-Ring (1).

Denso 10S11C, 10S11P

### K20-2170 Green HNBR

Metal Gasket Kit

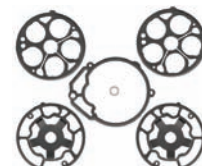

Includes: Cylinder Gasket (1), Front Valve Plate Gasket (1), Rear Valve Plate Gasket (1), Center Gasket (1), High Pressure Relief Valve O-Ring (1).

Denso 10S13C, 10S13P

### K20-2177 Green HNBR

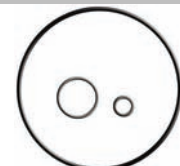

Includes: Case O-Ring (1), Discharge Manifold O-Ring (1), High Pressure Relief Valve O-Ring (1)

Denso SC5A06, SC5C06

## Gaskets

### K25-2110 Green HNBR

Metal Gasket Kit

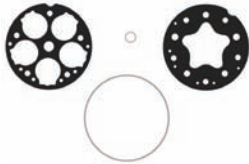

Includes: Head Gasket (Metal) (1), Cylinder Gasket (1), Case Lathe Cut Seal (1), Oil Plug O-Ring / Service Port O-Ring (Universal) (1)

Sanden SD505, SD507, SD507A2, SD508, SD510, SD5H09, SD5H11, SD5H13

### K25-2113 Green HNBR

Metal Gasket Kit(9\$.74 dia)



Includes: Cylinder Gasket (Metal) (1), Head Gasket (Metal) (1)

Sanden SD708, SD709, SD7H13, SD7H15

### K25-2114 Green HNBR

Metal Gasket Kit(4.74 dia)



Includes: Cylinder Gasket (Metal) (1), Head Gasket (Metal) (1), Case O-Ring(1), PRV O-Ring(1)

Sanden SD708, SD709, SD7H13, SD7H15

### K25-2115 Green HNBR

Metal Gasket Kit



Includes: Case Lathe Cut Seal (1), Cylinder Gasket (Metal) (1), Head Gasket (Metal) (1), Oil Plug O-Ring (1)

Sanden SD708, SD709, SD7H15

### K25-2118 Green HNBR

Metal Gasket Kit (Rover / Jaguar)



Includes: Head Gasket (Metal) (1), Cylinder Gasket (Metal) (1), Case Lathe Cut Seal (1), Service Port O-Ring (1)

Sanden SD7H15

### K25-2120 Green HNBR

Fiber Gasket Kit



Includes: Cylinder Gasket (Fiber) (1), Head Gasket (Fiber) (1), Case O-Ring (1), Valve Core O-Ring (1)

Sanden SD709CA

### K25-2125 Green HNBR

Fiber Gasket Kit



Includes: Head Gasket (1), Cylinder Gasket(1), Nose Piece O-Ring (1), Oil Drain Plug O-Ring (1)

Sanden SD7B10

### K25-2126 Green HNBR

Fiber Gasket Kit



Includes: Oil Plug O-Ring (1), Head Gasket (1), Cylinder Gasket (1), Case O-Ring (1), Internal Orifice Tube O-Ring (1), Pressure Relief Valve O-Ring (1), Suction / Discharge O-Ring (2), Pressure Regulator O-Ring (1)

Sanden SD7V16

### K25-2127 Green HNBR

Metal Gasket Kit



Includes: Oil Plug O-Ring (1), Head Gasket (1), Cylinder Gasket (1), Case O-Ring (1), Internal Orifice Tube O-Ring (1), Pressure Relief Valve O-Ring (1), Suction / Discharge O-Ring (2), Pressure Regulator O-Ring (1)

Sanden SD7V16

### K25-2128 Green HNBR

Metal Gasket Kit - Late Model

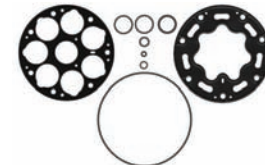

Includes: Oil Plug O-Ring (1), Head Gasket (1), Cylinder Gasket (1), Case O-Ring (1), Internal Orifice Tube O-Ring (1), Pressure Relief Valve O-Ring (1), Suction / Discharge O-Ring (2), Control Valve O-Ring (1)

Sanden SD7V16

### K25-2130 Green HNBR

Fiber Gasket Kit



Includes: Cylinder Gasket (Fiber) (1), Head Gasket (Fiber) (1), Case Lathe Cut (1)

Sanden SD709CP

### K25-2131 Green HNBR

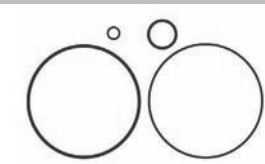

Includes: Rear Stationary Scroll O-Ring (1), Front Nose O-Ring (1), Pressure Relief Valve O-Ring (1), Oil Drain Plug O-Ring (1)

Sanden TR090, TRF090, TRS090

## Gaskets

**K25-2140** Green HNBR

Fiber Gasket Kit



Includes: Cylinder Gasket (1), Head Gasket (1), Lip Seal O-Ring (1), Case O-Ring (1), Oil Drain Plug O-Ring (1), Control Valve O-Ring (1).

Sanden SD6V12

**K25-2147** Green HNBR

Metal Gasket Kit



Includes: Cylinder Gasket (1), Head Gasket (1), Lip Seal O-Ring (1), Case O-Ring (1), Oil Drain Plug O-Ring (1), Control Valve O-Ring (1).

Sanden SD6V12

**K30-2112** Green HNBR

Fiber Gasket Kit



Includes: Front Head Gasket (1), Rear Head Gasket (1), Case O-Ring (Center) (1), Case O-Ring (Front and Rear) (2), Oil Plug O-Ring (1), Pressure Relief Valve O-Ring (1), Discharge Port O-Ring (1), Suction Port O-Ring (1)

Diesel Kiki DKS15CH

**K25-2141** Green HNBR

Metal Gasket Kit



Includes: Cylinder Gasket (1), Head Gasket (1), Case O-Ring (1)

Sanden SD7C16

**K25-2150** Green HNBR

O-Ring Kit

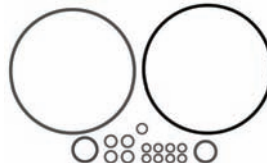

Includes: Front Head O-Ring(1), Scroll Rear O-Ring(1), Suction Port O-Ring(1), Front Head Bolt O-Ring(8), Rear Head Bolt O-Ring(4), PRV O-Ring(1), Discharge Port O-Ring(1)

Sanden TRSA12

**K30-2115** Green HNBR

Fiber Gasket Kit



Includes: Gaskets: Front Head(1), Rear Head(1), Intermediate Head(1), Center Case Molded(1); O-Rings: Case(3); Oil Fill Plug(1), Oil Drain Plug(1), Carbon Shaft Seal(1), Metal Shaft Seal Seat(1), Discharge Port O-Ring (1), Suction Port O-Ring (1).

Diesel Kiki DKS13G (DUAL)

**K25-2143** Green HNBR

Metal Gasket Kit



Includes: Front Head Gasket(1), Cylinder Gasket(1), Rear Head Gasket(1), Manifold Gasket(1), Suction Screen O-Ring(1), Oil Drain Bolt O-Ring(1), PRV O-Ring(1)

Sanden PXE13

**K25-2151** Green HNBR

O-Ring Kit

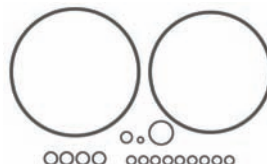

Includes: Front Head O-Ring(1), Scroll Rear O-Ring(1), Front Head Bolt O-Ring(9), Rear Head Bolt O-Ring(4), PRV O-Ring(1), Internal Orifice Tube O-Ring(1), Plug O-Ring(1)

Sanden TRSA09, TRSE07

**K30-2116** Green HNBR

Fiber Gasket Kit

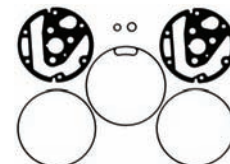

Includes: Head Gasket (2), Center Case Molded Gasket (HNBR) (1), Oil Fill Plug O-Ring (1), Case O-Ring (2), Oil Drain Plug O-Ring (1).

Diesel Kiki DKS13G (SINGLE), DKS15G

**K25-2146** Green HNBR

Metal Gasket Kit

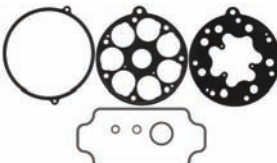

Includes: Front Head Gasket(1), Cylinder Gasket(1), Rear Head Gasket(1), Manifold Gasket(1), Suction Screen O-Ring(1), Oil Drain Bolt O-Ring(1), PRV O-Ring(1)

Sanden PXE16

**K30-2105** Green HNBR

Fiber Gasket Kit



Includes: Front Head Gasket (1), Rear Head Gasket (1), Oil Fill/Drain Plug O-Ring (2), Case O-Ring (3), Discharge Port O-Ring (1), Suction Port O-Ring (1), Metal Shaft Seal Seat O-Ring (1)

Diesel Kiki DKS15BH

**K30-2120** Green HNBR

Fiber Gasket Kit

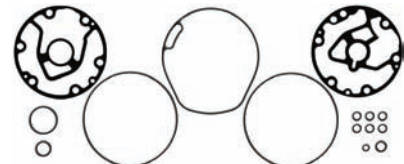

Includes: Front Head Gasket (1), Rear Head Gasket (1), Center Case Molded Gasket (1), Case O-Ring (2), Oil Fill Plug O-Ring (1), Oil Drain Plug O-Ring (1), Head Bolt O-Ring (6), Metal Shaft Seal Seat O-Ring (1), Carbon Shaft Seal O-Ring (1).

Diesel Kiki DKS16H(R12)

## Gaskets

**K30-2121** Green HNBR

Fiber Gasket Kit

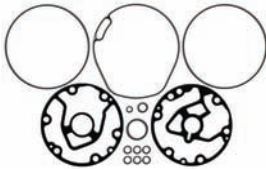

Includes: Front Head Gasket (1), Rear Head Gasket (1), Center Case Molded Gasket (1), Case O-Ring (2), Oil Fill Plug O-Ring (1), Oil Drain Plug O-Ring (1), Head Bolt O-Ring (6), Lip Seal O-Ring (1)

**Diesel Kiki** DKS16H(R134A)

**K30-2122** Green HNBR

Fiber Gasket Kit

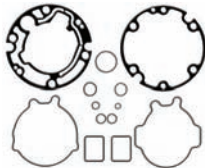

Includes: Gaskets: Rear Head(1), Front Head(1), Reed Plate Molded(2), Rear Molded (1), Front Molded(1); O-Rings: Rear Bellows Plunger(1), Bellows Plunger(1), Internal Front Rotor Housing to Nose(1), Pressure Relief Valve(1), Oil Bleed(1).

**Diesel Kiki** DCV11A, DKV11A

**K30-2123** Green HNBR

Fiber Gasket Kit

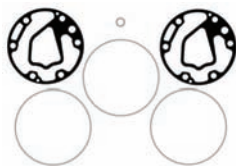

Includes: Head Gasket (2), Case O-Ring (3), Oil Plug O-Ring (1).

**Tama** TM08, TM08HD

**K30-2125** Green HNBR

Fiber Gasket Kit

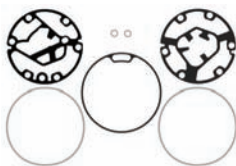

Includes: Front Head Gasket (1), Rear Head Gasket(1), Center Case Gasket (1), Case O-Ring (2), Oil Plug O-Ring (2).

**Diesel Kiki** DKS17S

**K30-2126** Green HNBR

Fiber Gasket Kit



Includes: Front Head Gasket (1), Rear Head Gasket (1), Center Case Molded Gasket (HNBR) (1), Case O-Ring (2), Oil Drain/Oil Fill Plug O-Ring (2) Carbon Shaft Seal O-Ring (1), Metal Shaft Seal Seat O-Ring (1), High Pressure Relief Valve O-Ring (1).

**Diesel Kiki** DKS13S, DKS15S

**K30-2129** Green HNBR

Fiber Gasket Kit

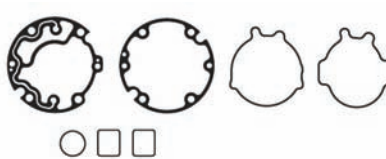

Includes: Reed Plate Molded Gasket (2), Front Head Gasket (1), Rear Molded Gasket (1), Front Molded Gasket (1), Rear Head Gasket (1), Front Nose to Case O-Ring (1).

**Diesel Kiki** DCV11D, DKV11D

**K30-2131** Green HNBR

Metal Gasket Kit



Includes: Gaskets: Front Head Gasket(1), Rear Head Gasket(1), Cylinder Gasket(1).

**Diesel Kiki** DCW17B, DCW17D

**K30-2136** Green HNBR

Metal Gasket Kit

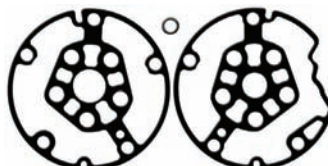

Includes: Front Head Gasket - Metal (1), Rear Head Gasket - Metal (1), Pressure Relief Valve O-Ring (1)

**Diesel Kiki** DKS17D

**K30-5003** Green HNBR

Gasket Kit

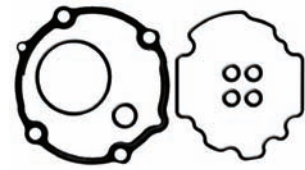

Includes: Front Head Gasket (1), Rotor Rear Gasket (1), Discharge Reed Bolt O-Ring (4), PRV O-Ring (1), Rotor Nose O-Ring

**Diesel Kiki** DCV14J, DKV11G, DKV14G

**K45-2106** Green HNBR

Fiber Gasket Kit

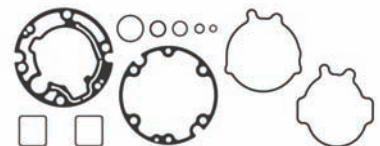

Includes: Gaskets: Rear Head(1), Front Head(1), Reed Plate Molded(2), Rear Molded (1), Front Molded(1); O-Rings: Rear Bellows Plunger(1), Bellows Plunger(1), Internal Front Rotor Housing to Nose(1), Pressure Relief Valve(1), Oil Bleed(1).

**Diesel Kiki** DCV14A

**K45-2107** Green HNBR

Metal Gasket Kit

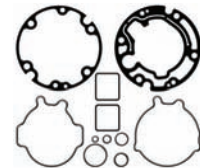

Includes: Gaskets: Rear Head(1), Front Head(1), Reed Plate Molded(2), Rear Molded (1), Front Molded(1); O-Rings: Rear Bellows Plunger(1), Bellows Plunger(1), Internal Front Rotor Housing to Nose(1), Pressure Relief Valve(1), Oil Bleed(1).

## Gaskets

### K45-2108 Green HNBR

Metal Gasket Kit - Late Model DCV14A

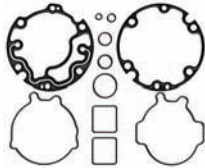

Includes: Gaskets: Rear Head(1), Front Head(1), Reed Plate Molded(2), Rear Molded (1), Front Molded(1); O-Rings: Rear Bellows Plunger(1), Bellows Plunger(1), Internal Front Rotor Housing to Nose(1), Pressure Relief Valve(1), Oil Bleed(1).

**Diesel Kiki** DCV14A

### K50-2105 Green HNBR

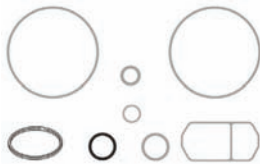

Includes : Discharge Manifold Gasket (HNBR) (1), Carbon Shaft Seal O-Ring (1), Sensor Housing O-Ring (1), Sensor O-Ring (1), Rotor O-Ring (Front and Rear) (2), Metal Shaft Seal Seat O-Ring (1), Rotor Ring Seal (1).

**Mats/Pan** S1150F3, S1150X3

### K50-2106 Green HNBR

Fiber Gasket Kit

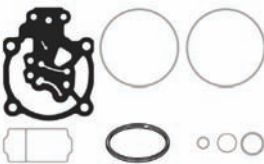

Includes: Head Gasket (1), Manifold Gasket (1), Case O-Ring (2), Temperature Switch O-Ring (1), Suction Housing O-Ring (1), Pressure Relief Valve O-Ring (1), Teflon Rotor Ring Seal (1).

**Mats/Pan** SA1150AE4

### K50-2107 Green HNBR

Fiber Gasket Kit

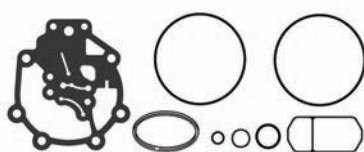

Includes: Case O-Ring (2), Suction O-Ring (1), Temperature Switch O-Ring (1), Pressure Relief Valve O-Ring (1), Teflon Rotor Ring Seal (1), Head Gasket (1), Suction Manifold Gasket (1)

**Mats/Pan** N1301AB4, N1301AD4, N1301AE4

### K50-2108 Green HNBR

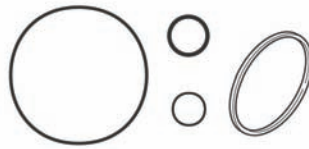

Includes: Temperature Switch O-Ring (1), Discharge Housing O-Ring (1), Rotor O-Ring (1), Rotor Ring Seal (1).

**Mats/Pan** S1150F3, S1150X3

### K50-2112 Green HNBR



Includes: Rotor Housing O-Ring (1), Discharge Housing O-Ring (1), High Pressure Relief Valve O-Ring (1)

**Mats/Pan** H12A1AH4DX

### K55-2105 Green HNBR

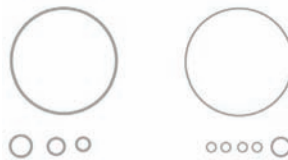

Includes: Sensor O-Ring (1), Stationary Scroll O-Ring (1), Front Case O-Ring (Outer) (1), Discharge Port O-Ring (1), Suction Port O-Ring (1), Lip Seal Outer O-Ring (1), Head Bolt O-Ring (4)

**Mitsubishi** FX80

### K55-2106 Green HNBR

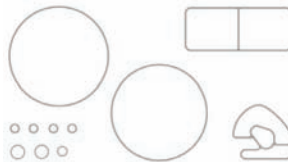

Includes: Gaskets: Suction/Discharge Housing(R134a)-Molded (1), Rear Control Housing-Molded (1); O-Rings: Temperature Sensor (1), Rear Housing Relief Port (1), Rear Case (1), Front Case (1), Pressure Relief Valve (1), Case Bolt (4).

**Mitsubishi** MSC105CVS

### K55-2107 Green HNBR

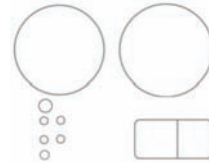

Includes: Suction / Discharge Housing Gasket (1), Pressure Release Valve O-Ring (1), Rear Case O-Ring (1), Front Nose Case O-Ring (1), Case Bolt O-Ring (4), Temperature Sensor O-Ring (1)

**Mitsubishi** MSC90, MSC90C

### K55-2109 Green HNBR

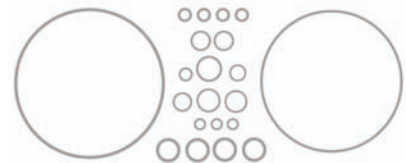

Includes: O-Rings: Rear Bolt(4), Front Case(1), Rear Case(1), Rear Control Block(3), Outside Bolt Plug(4), Pressure Relief Valve(1), Rear Control Block to Valves(2), Speed Sensor Connector(1), Speed Sensor(1), Control Valve Center(1)/Outer(1)/Inner(1).

**Mitsubishi** AX105VSR, FXA105VS, FXA105VSLR, FXA105VSR, FXA105VSSS

### K55-2110 Green HNBR

Gasket Kits

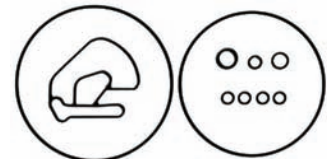

Includes: Front Case O-ring, Rear Case O-Ring, Control Body O-Ring, Temperature Switch O-Ring, PRV O-Ring, Rear Head Bolt O-Ring, Scroll Control Body Gasket

**Mitsubishi** MSC130CVSG, MSC130CVSG2

### K70-2101 Green HNBR

Metal Gasket Kit



Includes: Gaskets: Front Head Gasket(1), Cylinder Gasket(1), Rear Head Gasket(1), Discharge Port Molded Shape(1), Oil Drain Plug O-Ring(1), and PRV O-Ring(1).

**Zexel** DCS17E

## Gaskets

### K75-2100

Green HNBR

Metal Gasket Kit

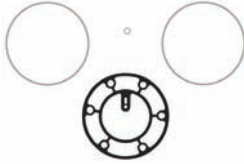

Includes: Head Gasket (Metal) (6.8 mm x 7.7 mm Oval Bolt Hole) (1), Pressure Relief Valve O-Ring (1), Case O-Ring (2)

**Calsonic** V5-15C, V5-15F, V5-15G

**Daewoo** V5

### K75-2101

Green HNBR

Fiber Gasket Kit

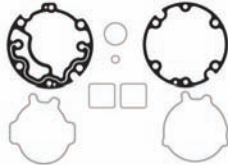

Includes: Rear Head Gasket (1), Front Head Gasket (1), Reed Plate Molded Gasket (2), Rear Molded Gasket (1), Front Molded Gasket (1), Internal Front Rotor Housing to Nose O-Ring (1), Pressure Relief Valve O-Ring (1)

**Calsonic** DKV14D

### K75-2102

Green HNBR

Fiber Gasket Kit

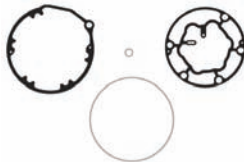

Includes: Front Head Gasket (1), Rear Head Gasket (1), Case O-Ring (1), High Pressure Relief Valve O-Ring (1)

**Calsonic** CWV615, CWV617, CWV618

### K95-2101

Green HNBR

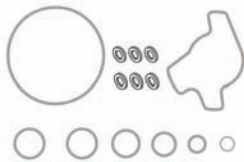

Includes: Head Bolt Washer (6), Rotor Body Gasket (1), Metal Shaft Seal Seat O-Ring (1), Case O-Ring (1), Rotor O-Ring (2), Internal Head O-Ring (1), Carbon Shaft Seal O-Ring (1), Suction Port O-Ring (1).

**Behr** WINGCELL

### K20-2048

Metal



Includes: Front Head Metal Gasket (1), Rear Head Metal Gasket (1).

**Denso** 10PA15A, 10PA15C, 10PA15E, 10PA15L, 10PA15LC, 10PA15SC, 10PA17A, 10PA17C, 10PA17E, 10PA17H, 10PA17J, 10PA17K, 10PA17SC, 10PA17SH

### K25-2116

Metal

Metal Gasket Kit

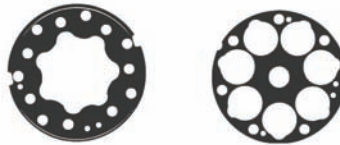

Includes: Head Gasket (Metal) (1), Cylinder Gasket (Metal) (1)

**Sanden** SD708, SD709, SD7H15

### K25-2117

Metal

Metal Gasket Kit (O.E.)



Includes: Head Gasket (Metal) (1), Cylinder Gasket (Metal) (1)

**Sanden** SD505, SD507, SD507A2, SD508, SD510, SD5H09, SD5H11, SD5H13

## Hard Components

### H20-1000

#### Front Head

Front Head



Denso 10PA15C, 10PA15SC,  
10PA17C, 10PA17E, 10PA17K,  
10PA17VC

### H20-1008

#### Front Head

Front Head



Denso 10PA20C

### H20-1013

#### Front Head

Front Head (Mercedes)



Denso 10PA20C

### H20-4526

#### Gut Pak

Gut Pak



Denso 10S11C, 10S11P

### A25-5000

#### Rear Head

VW SH Head



Sanden SD709

### H25-2002

#### Rear Head

Rear Head



Sanden SD708

### H20-5010

#### Shaft Components

Shaft and Swash Plate



Denso 10PA20C

### H20-5011

#### Shaft Components

Shaft and Swash Plate  
w/Sensor



Denso 10PA20C, 10PA20H

### H20-5042

#### Shaft Components

10S11 Swash Plate



Denso 10S11C

### H20-5043

#### Shaft Components

10S15 Swash Plate

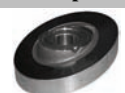

Denso 10S15C

### H20-5044

#### Shaft Components

10S17 Swash Plate



Denso 10S17C

### H20-5045

#### Shaft Components

10S20 Swash Plate



Denso 10S20C

### H20-5046

#### Shaft Components

Swash Plate & Shaft



Denso 10S11C

### H20-5047

#### Shaft Components

Swash Plate & Shaft



Denso 10S15C

### H20-5048

#### Shaft Components

Swash Plate & Shaft



Denso 10S17C

### H20-5049

#### Shaft Components

Swash Plate & Shaft



Denso 10S20C

## O-Rings and Lathe Cuts

### M10-1002 Black Nitrile

Alternate: M10-2102 (Green HNBR)

ID: 0.276" / 7.01mm  
OD: 0.394" / 10.01mm

Oil Drain Plug O-Ring

**Ford** SCROLL  
**Sanden** SD7V16

Rear Bolt O-Ring

**Mitsubishi** AX105VSR, FXA105VS,  
FXA105VSLR, FXA105VSR,  
FXA105VSSS

### M10-1010 Black Nitrile

Alternate: M10-2110 (Green HNBR)

ID: 0.563" / 14.30mm  
OD: 0.751" / 19.08mm

Carbon Shaft Seal O-Ring

**Hitachi** A5000, SWP123, SWP167

Discharge Port O-Ring (use with G11-2165)

**Denso** 10S15C, 10S15L, 10S17C,  
10S20C, 10S20F

### M11-1000 Black Nitrile

ID: 1.487" / 37.77mm  
OD: 1.693" / 43.00mm

Oil Drain Plug O-Ring

**Chrysler** RV2

### M11-1001 Black Nitrile

Alternate: M11-2101 (Green HNBR)

ID: 0.859" / 21.82mm  
OD: 1.137" / 28.88mm

Suction / Discharge Port O-Ring (Optional)

**GM/Harrison** R4

### M11-1002 Black Nitrile

Alternate: M11-2102 (Green HNBR)

ID: 0.921" / 23.39mm  
OD: 1.199" / 30.45mm

Shaft Seal Seat O-Ring

**Chrysler** A590, C171  
**Ford** FS6, FS6 CROSS MOUNT

### M11-1003 Black Nitrile

ID: 1.359" / 34.52mm  
OD: 1.637" / 41.58mm

Shaft Seal Seat O-Ring

**Chrysler** RV2

### M11-1004 Black Nitrile

ID: 2.609" / 66.27mm  
OD: 2.887" / 73.33mm

Nose Plate O-Ring

**Chrysler** RV2

### M11-1005 Black Nitrile

Alternate: M11-2105 (Green HNBR)

ID: 0.755" / 19.18mm  
OD: 0.949" / 24.10mm

Shaft Seal Seat O-Ring

**Mats/Pan** N1300AC4, N1301AB4,  
N1301AD4, N1301AE4, NL1300AA4,  
NL1300AB4, NL1300AE4, S1150F3,  
S1150X3, SA1150AE4

Suction / Discharge Port O-Ring (Aftermarket  
Hose Assembly)

**Denso** 10P08E, 10P13 Series,  
10P15 Series, 6E171, 6E171A, 6P  
Series

**Ford** FS6

### M11-1006 Black Nitrile

Alternate: M11-2106 (Green HNBR)

ID: 0.739" / 18.77mm  
OD: 0.879" / 22.33mm

Control Valve O-Ring

**Diesel Kiki** DCW17B, DCW17D

Control Valve Seat O-Ring

**Chrysler** 6C17

**Denso** 6CA17C

Plug O-Ring(TRSE07)

**Sanden** TRSE07

### M12-1003 Black Nitrile

Alternate: M12-2103 (Green HNBR)

ID: 0.266" / 6.76mm  
OD: 0.406" / 10.31mm

Oil Drain Plug O-Ring

**Delphi** CVC-125, CVC-135, CVC-  
135E, CVC6

### M12-1009 Black Nitrile

ID: 0.472" / 11.99mm  
OD: 0.630" / 16.00mm

Speed Sensor Connector O-Ring (on VSSS unit  
only)

**Mitsubishi** FXA105VSSS

### M12-1014 Black Nitrile

Alternate: M12-2114 (Green HNBR)

ID: 3.987" / 101.27mm  
OD: 4.193" / 106.50mm

Case O-Ring

**Ford** FS10, FS18, FX15

**GM/Harrison** DA6, HR6, HR6HE

**Nihon** DKV14B

**Visteon** HS15, HS17, HS18

Case O-Ring (Front/Rear & Center[HD6, Early  
HT6])

**GM/Harrison** HD6, HT6

Case O-Ring (Front/Rear)

**GM/Harrison** HU6

### M13-1001 Black Nitrile

Alternate: M13-2101 (Green HNBR)

ID: 1.220" / 30.99mm  
OD: 1.464" / 37.19mm

Lip Seal O-Ring (Large)

**GM/Harrison** HD6, HT6, HU6

### M13-1002 Black Nitrile

Alternate: M13-2102 (Green HNBR)

ID: 0.487" / 12.37mm  
OD: 0.693" / 17.60mm

Crossover O-Ring

**Hitachi** SWP123, SWP167

Rotor Ring O-Ring

**Mats/Pan** S1150AE4, S1150F3,  
S1150X3

### M13-1003 Black Nitrile

Alternate: M13-2103 (Green HNBR)

ID: 1.049" / 26.64mm  
OD: 1.255" / 31.88mm

Screen O-Ring

**Sanden** PXE16

Shaft Seal Seat O-Ring

**Behr** WINGCELL

**Keihin** 150L, 150R

**Nihon** DKV14B

Suction Screen O-Ring

**Sanden** PXE13

Superheat Adapter O-Ring (Beveled)

**GM/Harrison** A6

### M13-1004 Black Nitrile

Alternate: M13-2104 (Green HNBR)

ID: 1.237" / 31.42mm  
OD: 1.443" / 36.65mm

Lip Seal O-Ring

**Calsonic** V5-15C, V5-15F, V5-15G

**GM/Harrison** DA6, HR6, HR6HE, V5, V5  
(DESTROKER)

Lip Seal O-Ring (Small)

**GM/Harrison** HD6, HT6

Lip Seal O-Ring (Small)(Early)

**GM/Harrison** HU6

Shaft Seal Seat O-Ring

**Diesel Kiki** DKS16H(R12)

**GM/Harrison** A6, R4

### M13-1005 Black Nitrile

ID: 2.612" / 66.34mm  
OD: 2.818" / 71.58mm

Housing to Receiver Shell O-Ring (Lower)

**GM/Harrison** VIR

### M13-1006 Black Nitrile

ID: 2.987" / 75.87mm  
OD: 3.193" / 81.10mm

Inlet Connector Shell to Housing O-Ring

**GM/Harrison** VIR



## O-Rings and Lathe Cuts

### M13-1007 Black Nitrile

Alternate: M13-2107 (Green HNBR)  
ID: 4.237" / 107.62mm  
OD: 4.443" / 112.85mm

Case O-Ring

**Behr** WINGCELL  
**GM/Harrison** A6  
**Nihon** DKV14C, NVR140S

Case O-Ring (Center [Late HT6])

**GM/Harrison** HT6

Case O-Ring (Center)

**GM/Harrison** HU6

### M13-1008 Black Nitrile

Alternate: M13-2108 (Green HNBR)  
ID: 4.487" / 113.97mm  
OD: 4.693" / 119.20mm

Case O-Ring

**Denso** 10P17 Series  
**GM/Harrison** V5, V5 (DESTROKER), V7

### M13-1009 Black Nitrile

Alternate: M13-2109 (Green HNBR)  
ID: 1.239" / 31.47mm  
OD: 1.379" / 35.03mm

POA Valve O-Ring

**GM/Harrison** VIR

### M13-1011 Black Nitrile

Alternate: M13-2111 (Green HNBR)  
ID: 0.989" / 25.12mm  
OD: 1.129" / 28.68mm

Expansion Valve O-Ring (Upper & Center)

**GM/Harrison** VIR

Superheat Adapter O-Ring (Captive)

**GM/Harrison** A6

### M13-1013 Black Nitrile

Alternate: M13-2113 (Green HNBR)  
ID: 1.114" / 28.30mm  
OD: 1.254" / 31.85mm

Rotor Body Housing O-Ring (Front)

**Nihon** DKV14C

### M13-1014 Black Nitrile

Alternate: M13-2114 (Green HNBR)  
ID: 5.984" / 151.99mm  
OD: 6.262" / 159.05mm

Case O-Ring

**GM/Harrison** R4

### M20-1010 Black Nitrile

ID: 3.937" / 100.00mm  
OD: 4.133" / 104.98mm

Case O-Ring

**Denso** 10P08E

### M20-1015 Black Nitrile

Alternate: M20-2115 (Green HNBR)  
ID: 0.906" / 23.01mm  
OD: 1.064" / 27.03mm

Adapter O-Ring

**Denso** TV12C(R12), TV12C(R134),  
TV12SC(R134), TV14C, TV14SC

Control Valve (4 O-Ring) Inner O-Ring

**Denso** 6SEU16

Control Valve Inner O-Ring

**Denso** 6SEU12, 6SEU12C,  
6SEU14C

Control Valve Outer O-Ring

**Denso** 5SE09C, 7SBU17C,  
7SEU17C

**Denso** 7SEU16

Internal Valve Plate O-Ring

**Denso** 6P127A, 6P127B, 6P127D

Valve Plate O-Ring

**Denso** 10P13 Series, 10P15 Series

### M20-1016 Black Nitrile

Alternate: M20-2116 (Green HNBR)  
ID: 0.591" / 15.01mm  
OD: 0.787" / 19.99mm

Body Sensor Port O-Ring

**Denso** 10P13C, 10P15C, 10P17C,  
10PA15C, 10PA15SC, 10PA17C,  
10PA17SC, 10PA17SH, 10PA17VC,  
10PA17VSC, 10PA20C, 10PA20SC,  
10S15C, 10S15L, 10S17C, 10S20C,  
10S20F, 10S20H

Bottom/Side Switch O-Ring

**Denso** 10PA17VL

Carbon Shaft Seal O-Ring

**Hitachi** MJ110, MJ123, MJ167,  
MJS130, MJS170

Control Valve Middle O-Ring

**Denso** 5SE09C, 7SBU17C

Suction and Discharge Port O-Ring (DN1)

**Seiko-Seiki** SS121DN1

### M20-1018 Black Nitrile

Alternate: M20-2118 (Green HNBR)  
ID: 0.984" / 24.99mm  
OD: 1.220" / 30.99mm

Lip Seal O-Ring

**Calsonic** CWV615, CWV617,

**Chrysler** 6C17

**Denso** 10PA20C, 10PA20H,  
10PA20J, 10PA20SC, 10PA20SH,  
10PA20VC

**Diesel Kiki** DKS16H(R134A)

**GM/Harrison** V7

Shaft Seal Seat (Pre 1992)/Lip Seal O-Ring

**Denso** 10P08E

Shaft Seal Seat / Lip Seal O-Ring

**Denso** 10PA15 Series, 10PA17 Series

Shaft Seal Seat O-Ring

**Denso** 10P17 Series, 6E171,  
6E171A, 6P Series, TV10 Series,  
TV12C(R12), TV12EC(R12), TV14C,  
TV14EC

Shaft Seal Seat O-Ring (Use on S11-3101 only)

**Chrysler** A590, C171

**Ford** FS6, FS6 CROSS MOUNT

**Seiko-Seiki** SS170PSS

Shaft Seal Seat/Lip Seal O-Ring

**Denso** 10P13 Series, 10P15 Series

### M20-1023 Black Nitrile

ID: 1.378" / 35.00mm  
OD: 1.614" / 41.00mm

Shaft Seal Seat O-Ring

**Bosch** AXIAL

### M20-1032 Black Nitrile

Alternate: M20-2132 (Green HNBR)

ID: 0.551" / 14.00mm  
OD: 0.709" / 18.01mm

Control Valve Inner Middle O-Ring

**Denso** 5SE09C, 7SBU17C

Control Valve Inner O-Ring

**Denso** 7SE16

Temperature Switch Block O-Ring

**Denso** TV10 Series, TV12 Series,  
TV14 Series

### M20-1035 Black Nitrile

Alternate: M20-2135 (Green HNBR)

ID: 4.134" / 105.00mm  
OD: 4.330" / 109.98mm

Case O-Ring

**Calsonic** CSV613

**Denso** 10P13 Series, 10P15 Series

Case O-Ring (Front and Rear)

**Diesel Kiki** DKS15CH

### M20-1040 Black Nitrile

Alternate: M20-2140 (Green HNBR)

ID: 4.252" / 108.00mm  
OD: 4.488" / 114.00mm

Case O-Ring

**Denso** 10PA15 Series, 10PA17  
Series, 6P148, 6P148A, 6P148C

Case O-Ring (6P127A/B)

**Denso** 6P127A, 6P127B

Case O-Ring (Front)

**Calsonic** CR14

Case O-Ring (Front) (TRSE07/TRSA09)

**Sanden** TRSA09, TRSE07

### M20-1045 Black Nitrile

ID: 4.331" / 110.01mm  
OD: 4.489" / 114.02mm

Case O-Ring

**Diesel Kiki** DKS17G (DUAL), DKS17G  
(SINGLE)

## O-Rings and Lathe Cuts

### Case O-Ring (Front & Rear) (6E171)

**Denso** 6E171

#### M20-1058 Black Nitrile

Alternate: M20-2158 (Green HNBR)

ID: 4.528" / 115.01mm  
OD: 4.686" / 119.02mm

### Case O-Ring

**Denso** 6CA17C, 6P134

**Hitachi** MJS170

**Mitsubishi** AX105VSR, FXA105VS,  
FXA105VSLR, FXA105VSR,  
FXA105VSSS

**Sanden** SD7V16

### Case O-Ring (Rear)

**Mitsubishi** MSC130CVSG,  
MSC130CVSG2

### Rear Scroll Housing O-Ring

**Mitsubishi** FX105V

#### M20-1059 Black Nitrile

Alternate: M20-2159 (Green HNBR)

ID: 4.488" / 114.00mm  
OD: 4.724" / 119.99mm

### Case O-Ring

**Denso** 10PA20C, 10PA20H,  
10PA20J, 10PA20SC, 10PA20SH,  
10PA20VC

### Case O-Ring (Center)

**Diesel Kiki** DKS15CH

### Rear Scroll O-Ring

**Sanden** TR105, TR105VS, TRF105,  
TRS105

### Rear Scroll O-Ring (TRSA12)

**Sanden** TRSA12

#### M20-1065 Black Nitrile

ID: 4.646" / 118.01mm  
OD: 4.882" / 124.00mm

### Case O-Ring (Front, Rear & Center) (6E171A)

**Denso** 6E171A

### Case O-Ring (Front and Rear)

**Diesel Kiki** DKS17CH

### Case O-Ring (Front) (TRSA12)

**Sanden** TRSA12

#### M20-1070 Black Nitrile

ID: 4.724" / 119.99mm  
OD: 4.882" / 124.00mm

### Case O-Ring

**Mitsubishi** FX105V

**Sanden** TR105, TR105VS, TRF105,  
TRS105

### Case O-Ring (Center) (6E171)

**Denso** 6E171

#### M20-1071 Black Nitrile

Alternate: M20-2171 (Green HNBR)

ID: 1.296" / 32.92mm  
OD: 1.574" / 39.98mm

### Rear Head Sensor Port O-Ring (For C20-2001-Toyota/Mercedes)

**Denso** 10P15C, 10PA15C

### Rotor O-Ring

**Behr** WINGCELL

#### M25-1001 Black Nitrile

Alternate: M25-2101 (Green HNBR)

ID: 0.138" / 3.51mm  
OD: 0.256" / 6.50mm

### Internal Orifice Tube O-Ring

**Ford** LARGE SCROLL

**Sanden** PXV16, SD7V16, TRSA09,  
TRSA12, TRSE07

#### M25-1010 Black Nitrile

ID: 3.150" / 80.01mm  
OD: 3.386" / 86.00mm

### Nose Piece O-Ring (Early)

**Sanden** TR70

#### M25-1017 Black Nitrile

Alternate: M25-2117 (Green HNBR)

ID: 1.161" / 29.49mm  
OD: 1.319" / 33.50mm

### Internal Front Rotor Housing to Nose O-Ring

**Calsonic** DKV14D

**Diesel Kiki** DCV11A, DCV11D,  
DCV14A, DKV11A, DKV11D

### Internal Rotor O-Ring

**Seiko-Seiki** SS170PSS

### Rear Internal Screen Body O-Ring

**Seiko-Seiki** SS121DN1, SS121DN2,  
SS121DV2

### Shaft Seal Seat O-Ring

**Sanden** SD507, SD507A2, SD508,  
SD510

#### M25-1018 Black Nitrile

ID: 2.800" / 71.12mm  
OD: 3.006" / 76.35mm

### Nose Piece O-Ring (Late)

**Sanden** TR70

#### M25-1020 Black Nitrile

ID: 4.109" / 104.37mm  
OD: 4.387" / 111.43mm

### Rear Scroll O-Ring

**Sanden** TR70

#### M25-1021 Black Nitrile

ID: 2.864" / 72.75mm  
OD: 3.004" / 76.30mm

### Nose Piece O-Ring (Mid)

**Sanden** TR70

#### M30-1000 Black Nitrile

Alternate: M30-2100 (Green HNBR)

ID: 0.799" / 20.29mm  
OD: 1.005" / 25.53mm

### Lip Seal / Suction Port O-Ring

**Diesel Kiki** DKS15CH, DKS17CH

### Lip Seal O-Ring

**Delphi** SP10

**Denso** 6CA17C, 7SB16C

**Diesel Kiki** DKS13CH

**Hadsys** RC17D, RC17S

**Sanden** SD5H09, SD5H11, SD5H13,  
SD6V12, SD708, SD709, SD709CA,  
SD709CP, SD7B10, SD7H13, SD7H15,  
SD7V16

**Seiko-Seiki** SS121DN1, SS121DN2,  
SS121DV2

**Tama** TM08HD

### Shaft Seal Seat O-Ring

**Mitsubishi** FX105V

**Sanden** SD505, TR70

### Shaft Seal Seat O-Ring (Small)

**Nihon** DKV14C

### Suction Port O-Ring

**Diesel Kiki** DKS13G (DUAL), DKS13G  
(SINGLE), DKS15BH, DKS15G,  
DKS17G (DUAL), DKS17G (SINGLE)

### Suction Port O-Ring (TRSA12)

**Sanden** TRSA12

### Suction Port O-Ring/Metal Shaft Seal O-Ring

**Sanden** TR105, TR105VS, TRF105,  
TRS105

### Suction Port O-Ring/Shaft Seal Seat O-Ring

**Sanden** TR090, TRF090, TRS090

#### M30-1001 Black Nitrile

Alternate: M30-2101 (Green HNBR)

ID: 0.987" / 25.07mm  
OD: 1.193" / 30.30mm

### Shaft Seal Seat O-Ring

**Diesel Kiki** DKS13G (DUAL), DKS13G  
(SINGLE), DKS15BH, DKS15G,  
DKS15S, DKS17G (DUAL), DKS17G  
(SINGLE)

#### M30-1018 Black Nitrile

ID: 0.984" / 24.99mm  
OD: 1.180" / 29.97mm

### Rear Plunger O-Ring

**Denso** 10PA15VC, 10PA15VL,  
10PA17VC, 10PA17VL, 10PA17VSC

### Shaft Seal Seat O-Ring

**Nihon** NVR140S

### Shaft Seal Seat O-Ring (Large)

**Nihon** DKV14C

## O-Rings and Lathe Cuts

### M35-1000 Black Nitrile

ID: 0.787" / 19.99mm  
OD: 0.905" / 22.99mm

Internal Suction O-Ring

**Seiko-Seiki** SS170PSS

Rear Internal Suction O-Ring (DN2)

**Seiko-Seiki** SS121DN2

### M35-1001 Black Nitrile

ID: 3.622" / 92.00mm  
OD: 3.780" / 96.01mm

Case O-Ring (Center)

**Seiko-Seiki** SS170PSS

Case O-Ring (Rear)

**Seiko-Seiki** SS121DN1, SS121DN2,  
SS121DV2

### M35-1002 Black Nitrile

ID: 3.858" / 97.99mm  
OD: 4.094" / 103.99mm

Case O-Ring (Front)

**Seiko-Seiki** SS121DN1, SS121DN2,  
SS121DV2, SS170PSS

### M35-1003 Black Nitrile

ID: 3.307" / 84.00mm  
OD: 3.543" / 89.99mm

Front Case O-Ring

**Seiko-Seiki** SS10LV6, SS10V1, SS10V6,  
SS96D1, SS96D2

### M35-1004 Black Nitrile

ID: 3.150" / 80.01mm  
OD: 3.308" / 84.02mm

Rear Case O-Ring

**Seiko-Seiki** SS10LV6, SS10V1, SS10V6,  
SS96D1, SS96D2

### M35-1005 Black Nitrile

ID: 1.063" / 27.00mm  
OD: 1.221" / 31.01mm

Rear Discharge Plate O-Ring

**Calsonic** CR14

Rotor Body Rear O-Ring

**Seiko-Seiki** SS10LV6, SS10V1, SS10V6,  
SS96D1, SS96D2

### M40-1000 Black Nitrile

ID: 3.239" / 82.27mm  
OD: 3.379" / 85.83mm

Rear Bearing Plate O-Ring

**York** 206, 209, 210, SC206, SC209

### M45-1001 Black Nitrile

Alternate: M45-2101 (Green HNBR)

ID: 0.709" / 18.01mm  
OD: 0.905" / 22.99mm

Carbon Seal Head O-Ring

**Nihon** NVR140S

### M45-1002 Black Nitrile

Alternate: M45-2102 (Green HNBR)

ID: 1.339" / 34.01mm  
OD: 1.497" / 38.02mm

Rear Rotor Body O-Ring

**Nihon** NVR140S

### M45-1003 Black Nitrile

Alternate: M45-2103 (Green HNBR)

ID: 1.575" / 40.01mm  
OD: 1.733" / 44.02mm

Front Rotor Body O-Ring

**Nihon** NVR140S

### M45-1004 Black Nitrile

ID: 2.989" / 75.92mm  
OD: 3.129" / 79.48mm

Valve Body O-Ring (Front)

**Nihon** DKV14B

### M45-1005 Black Nitrile

ID: 1.174" / 29.82mm  
OD: 1.380" / 35.05mm

Valve Body O-Ring (Rear)

**Nihon** DKV14B

### M45-1006 Black Nitrile

ID: 3.737" / 94.92mm  
OD: 3.943" / 100.15mm

Case O-Ring

**Denso** SCS06C, SCSA06, SCSC06

Rear Bearing Plate O-Ring

**Tecumseh** HG1000, HG850

### M50-1001 Black Nitrile

Alternate: M50-2101 (Green HNBR)

ID: 3.307" / 84.00mm  
OD: 3.465" / 88.01mm

Case O-Ring

**Mats/Pan** N1300AC4, N1301AB4,  
N1301AD4, N1301AE4, NL1300AA4,  
NL1300AB4, NL1300AE4

Rear Plate O-Ring

**Tecumseh** HG500

### M50-1002 Black Nitrile

ID: 0.787" / 19.99mm  
OD: 0.983" / 24.97mm

Suction/Discharge/Dust Shield O-Ring

**Denso** 6CA17C

### M50-1003 Black Nitrile

Alternate: M50-2103 (Green HNBR)

ID: 0.591" / 15.01mm  
OD: 0.709" / 18.01mm

Control Valve Middle O-Ring

**Mitsubishi** AX105VSR, FXA105VS,  
FXA105VSLR, FXA105VSR,  
FXA105VSSS

**Zexel** DCS17E

Discharge Housing O-Ring

**Mats/Pan** H12A1AH4DX, N1300AC4,  
N1301AB4, N1301AD4, N1301AE4,  
NL1300AA4, NL1300AB4, NL1300AE4

Rear Housing Body O-Ring

**Mitsubishi** FX105V

### M50-1004 Black Nitrile

Alternate: M50-2104 (Green HNBR)

ID: 0.531" / 13.49mm  
OD: 0.727" / 18.47mm

Front Head Switch O-Ring

**Mats/Pan** N1300AC4, NL1300AA4,  
NL1300AB4, NL1300AE4

### M50-1005 Black Nitrile

Alternate: M50-2105 (Green HNBR)

ID: 0.492" / 12.50mm  
OD: 0.688" / 17.48mm

Carbon Shaft Seal O-Ring

**Mats/Pan** N1300AC4, N1301AB4,  
N1301AD4, N1301AE4, NL1300AA4,  
NL1300AB4, NL1300AE4, S1150F3,  
S1150X3, SA1150AE4

### M50-1012 Black Nitrile

Alternate: M50-2112 (Green HNBR)

ID: 2.992" / 76.00mm  
OD: 3.150" / 80.01mm

Case O-Ring

**Mats/Pan** SA1150AE4

Rotor Housing O-Ring

**Mats/Pan** H12A1AH4DX

Rotor O-Ring (Front and Rear)

**Mats/Pan** S1150F3, S1150X3

### M55-1003 Black Nitrile

Alternate: M55-2103 (Green HNBR)

ID: 3.489" / 88.62mm  
OD: 3.629" / 92.18mm

Nose Plate O-Ring

**Mitsubishi** FX105V

### M60-1000 Black Nitrile

Alternate: M60-2100 (Green HNBR)

ID: 5.239" / 133.07mm  
OD: 5.379" / 136.63mm

Case O-Ring (Outer)

**Keihin** 150L

### M60-1012 Black Nitrile

ID: 1.890" / 48.01mm  
OD: 2.048" / 52.02mm

Head Plate O-Ring

**Keihin** 150L, 150R

### M60-1013 Black Nitrile

ID: 1.575" / 40.01mm  
OD: 1.693" / 43.00mm

Piston O-Ring (Fits under Piston Ring)

**Keihin** 150L, 150R

## O-Rings and Lathe Cuts

### M60-1065 Black Nitrile

ID: 5.512" / 140.00mm  
OD: 5.670" / 144.02mm

Case O-Ring (Outer)

**Keihin** 150R

### M65-1005 Black Nitrile

Alternate: M65-2105 (Green HNBR)

ID: 0.236" / 5.99mm  
OD: 0.394" / 10.01mm

Case O-Ring

**Delphi** CVC6

Oil Drain Plug O-Ring

**Bosch** AXIAL

**Delphi** CVC-135E, CVC-165, CVC-185, CVC7P

Pickup Tube O-Ring

**Hitachi** SWP123, SWP167

### M65-1006 Black Nitrile

Alternate: M65-2106 (Green HNBR)

ID: 0.630" / 16.00mm  
OD: 0.788" / 20.02mm

Control Valve Middle O-Ring

**Denso** 7SE16

Speed Sensor O-Ring

**Diesel Kiki** DCW17B, DCW17D

### M65-1015 Black Nitrile

Alternate: M65-2115 (Green HNBR)

ID: 0.472" / 11.99mm  
OD: 0.668" / 16.97mm

Carbon Shaft Seal O-Ring

**Mitsubishi** FX105V

**Sanden** SD505, TR090, TR105, TR105VS, TR70, TRF090, TRF105, TRS090, TRS105

Crossover Tube O-Ring

**Hitachi** A5000, MJ110, MJ123, MJ167, MJS130, MJS170

### M65-1025 Black Nitrile

ID: 2.362" / 59.99mm  
OD: 2.520" / 64.01mm

Inner Valve Plate O-Ring

**Hitachi** MJ110, MJ123, MJ167, MJS130

Shaft Seal Plate O-Ring (use w/ S40-3003)

**York** 206, 209, 210

### M65-1031 Black Nitrile

ID: 2.520" / 64.01mm  
OD: 2.678" / 68.02mm

Inner Valve Plate O-Ring

**Hitachi** MJS170

### M65-1033 Black Nitrile

Alternate: M65-2133 (Green HNBR)

ID: 4.016" / 102.01mm  
OD: 4.174" / 106.02mm

Case O-Ring

**Delphi** SP10

Case O-Ring - Front

**Visteon** HS090L, HS090R, HS110R

Case O-Ring (Inner)

**Keihin** 150L, 150R

### M65-1035 Black Nitrile

Alternate: M65-2135 (Green HNBR)

ID: 4.291" / 108.99mm  
OD: 4.449" / 113.00mm

Case O-Ring

**Diesel Kiki** DKS13G (DUAL), DKS13G (SINGLE), DKS13S, DKS15BH, DKS15G, DKS15S

**Hitachi** A5000

**Mitsubishi** MSC90, MSC90C

**Sanden** SD709CA, TR70

**Tama** TM08HD

Case O-Ring (Front)

**Mitsubishi** MSC105CVS

Case O-Ring (Rear)

**Hitachi** MJ110, MJ123, MJ167, MJS130, SWP123, SWP167

Outer Valve Plate O-Ring

**Hitachi** MJS170

Rear Scroll O-Ring

**Mitsubishi** AX105VSR, FXA105VS, FXA105VSLR, FXA105VSR, FXA105VSSS

### M94-1000 Black Nitrile

ID: 0.101" / 2.57mm  
OD: 0.241" / 6.12mm

Control Valve Plunger O-Ring (Bottom)

**Denso** 10PA15VC, 10PA15VL, 10PA17VC, 10PA17VL, 10PA17VSC

### M94-1002 Black Nitrile

Alternate: M94-2102 (Green HNBR)

ID: 1.301" / 33.05mm  
OD: 1.441" / 36.60mm

Control Valve Cover Gasket

**Ford** LARGE SCROLL

Internal Front Housing to Nose O-Ring

**Diesel Kiki** DCV14J, DKV11G, DKV14G, DKV14J

### M94-1008 Black Nitrile

ID: 2.239" / 56.87mm  
OD: 2.379" / 60.43mm

Bottom Plate O-Ring

**Tecumseh** HG500

### M94-1018 Black Nitrile

ID: 4.989" / 126.72mm  
OD: 5.129" / 130.28mm

Case O-Ring

**Hadsys** RC17D, RC17S

### M95-1001 Black Nitrile

Alternate: M95-2101 (Green HNBR)

ID: 0.709" / 18.01mm  
OD: 0.867" / 22.02mm

Control Valve Seat O-Ring

**Denso** 7SB16C

Suction Port O-Ring

**Behr** WINGCELL

### M95-1005 Black Nitrile

Alternate: M95-2105 (Green HNBR)

ID: 0.551" / 14.00mm  
OD: 0.787" / 19.99mm

Carbon Shaft Seal O-Ring

**Bosch** AXIAL

### M95-1006 Black Nitrile

Alternate: M95-2106 (Green HNBR)

ID: 0.208" / 5.28mm  
OD: 0.348" / 8.84mm

Discharge Reed Bolt O-Ring

**Diesel Kiki** DCV14J, DKV11G, DKV14G

Oil Pickup Tube O-Ring

**Bosch** AXIAL

### M95-1007 Black Nitrile

Alternate: M95-2107 (Green HNBR)

ID: 0.864" / 21.95mm  
OD: 1.004" / 25.50mm

Discharge Port O-Ring

**Denso** SCS06C

### M95-1008 Black Nitrile

Alternate: M95-2108 (Green HNBR)

ID: 1.364" / 34.65mm  
OD: 1.504" / 38.20mm

Internal Head O-Ring

**Behr** WINGCELL

Rotor Body Housing O-Ring (Rear)

**Nihon** DKV14C

### M96-1002 Black Nitrile

Alternate: M96-2102 (Green HNBR)

ID: 0.239" / 6.07mm  
OD: 0.379" / 9.63mm

Oil Drain Plug O-Ring

**Diesel Kiki** DKS16H(R12), DKS16H(R134A)

### M96-1009 Black Nitrile

Alternate: M96-2109 (Green HNBR)

ID: 0.301" / 7.65mm  
OD: 0.441" / 11.20mm

Case Bolt O-Ring

**Mitsubishi** MSC105CVS, MSC90, MSC90C

Condenser Line O-Ring / Pickup Tube O-Ring

**GM/Harrison** VIR

Destroker Valve Plate O-Ring (Older Model)

**GM/Harrison** V5 (DESTROKER)

## O-Rings and Lathe Cuts

### Oil Drain Plug O-Ring

**Diesel Kiki** DKS13G (DUAL), DKS13G (SINGLE), DKS13S, DKS15CH, DKS15G, DKS15S, DKS17CH, DKS17G (DUAL), DKS17G (SINGLE), DKS17S

### Pressure Relief Valve/Oil Drain Plug O-Ring

**Diesel Kiki** DCW17B, DCW17D

### Service Port O-Ring

**Seiko-Seiki** SS170PSS

### Service Valve O-Ring

**Sanden** SD708, SD709, SD709CA

### **M96-1010** **Black Nitrile**

Alternate: M96-2110 (Green HNBR)

ID: 0.301" / 7.65mm  
OD: 0.429" / 10.90mm

### Discharge Crossover O-Ring

**GM/Harrison** DA6, HD6, HR6, HR6HE, HT6

### Rear Head Bolt O-Ring

**Mitsubishi** FX105V, FX80, MSC130CVSG, MSC130CVSG2

### **M96-1015** **Black Nitrile**

Alternate: M96-2115 (Green HNBR)

ID: 0.351" / 8.92mm  
OD: 0.495" / 12.57mm

### Pressure Relief Valve O-Ring

**Calsonic** DKV14D  
**Diesel Kiki** DCV11A, DCV14A, DKV11A, DKV11G, DKV14G

### **M96-1016** **Black Nitrile**

Alternate: M96-2116 (Green HNBR)

ID: 0.362" / 9.19mm  
OD: 0.568" / 14.43mm

### Long Control Valve O-Ring (Outer)

**Chrysler** 6C17

### Rear Housing Body O-Ring

**Mitsubishi** FX80

### Suction/Discharge Port O-Ring

**Nihon** DKV14C

### **M96-1018** **Black Nitrile**

Alternate: M96-2118 (Green HNBR)

ID: 0.364" / 9.25mm  
OD: 0.504" / 12.80mm

### Control Valve (Inner) / High PSI Relief Valve O-Ring

**Calsonic** CWV615, CWV617, CWV618, V5-15C, V5-15F, V5-15G

**Daewoo** V5

**Delphi** CVC-125, CVC-135, CVC-165, CVC-185, CVC6, CVC7P

**GM/Harrison** V5, V5 (DESTROKER), V7

### Control Valve Inner / High PSI Relief Valve O-Ring

**Calsonic** CSV613

### Control Valve Mount / High PSI Relief Valve O-Ring

**Denso** 10PA15VC, 10PA15VL, 10PA17VC, 10PA17VL, 10PA17VSC, 10S20H, SCS06C, SCSEA06, SCSC06

### Control Valve O-Ring (Inner)

**Mitsubishi** FX105V

### Head Bolt O-Ring, Rear

**Sanden** TRSA09, TRSA12, TRSE07

### High Pressure Relief Valve O-Ring

**Bosch** AXIAL

**Chrysler** 6C17

**Denso** 10S11C, 10S11P, 10S13C, 10S13P, 10S15C, 10S15L, 10S17C, 10S20C, 10S20F, 6SEU12, 6SEU12C, 6SEU14C, 6SEU16, 7SBU17C, 7SE16, 7SEU17C, SC08 (ITALY), SC08C (SPAIN), TV12C(R134), TV12SC(R134), TV14SC

**Diesel Kiki** DKS13S, DKS15S

**GM/Harrison** A6, DA6, HD6, HR6, HR6HE, HT6, HU6, R4

**Hadsys** RC17D, RC17S

**Mats/Pan** H12A1AH4DX, N1301AB4, N1301AD4, N1301AE4, SA1150AE4

**Mitsubishi** MSC105CVS

**Sanden** PXV16, SD7B10, SD7V16, TR090, TR105, TR105VS, TRF090, TRF105, TRS090, TRS105

**Visteon** HS15, HS17, HS18

### High Pressure Relief Valve O-Ring (HS090L/R)

**Visteon** HS090L, HS090R

### High PSI Relief Valve O-Ring

**Delphi** CVC-135E

### Oil Drain Plug / Service Port O-Ring

**Sanden** SD505, SD507, SD507A2, SD508, SD510, SD5H09, SD5H11, SD5H13, SD7H13, SD7H15

### Oil Drain Plug O-Ring

**Sanden** SD708, SD709

**York** 206, 209, 210, SC206, SC209

### PRV Relief Valve O-Ring

**Denso** 7SEU16

### **M96-1021** **Black Nitrile**

Alternate: M96-2121 (Green HNBR)

ID: 0.414" / 10.52mm  
OD: 0.558" / 14.17mm

### Discharge Port O-Ring

**Calsonic** CR14

### **M96-1022** **Black Nitrile**

Alternate: M96-2122 (Green HNBR)

ID: 0.424" / 10.77mm  
OD: 0.630" / 16.00mm

### Discharge Port O-Ring

**Mitsubishi** FX80

### Pressure Relief Valve O-Ring

**Seiko-Seiki** SS10LV6, SS10V1, SS10V6

### Sightglass O-Ring

**GM/Harrison** VIR

### **M96-1023** **Black Nitrile**

Alternate: M96-2123 (Green HNBR)

ID: 0.426" / 10.82mm  
OD: 0.566" / 14.38mm

### Control Valve O-Ring (Inside Center)

**Calsonic** CWV615, CWV617, CWV618, V5-15C, V5-15F, V5-15G

**Daewoo** V5

**Delphi** CVC-125, CVC-135, CVC-165, CVC-185, CVC6, CVC7P

**GM/Harrison** V5, V5 (DESTROKER), V7

### Discharge Port O-Ring

**Sanden** TR70

### Evaporator Inlet Line Connection O-Ring

**GM/Harrison** VIR

### **M96-1029** **Black Nitrile**

Alternate: M96-2129 (Green HNBR)

ID: 0.489" / 12.42mm  
OD: 0.629" / 15.98mm

### Control Valve O-Ring (Center)

**Mitsubishi** FX105V

### **M96-1032** **Black Nitrile**

Alternate: M96-2132 (Green HNBR)

ID: 0.551" / 14.00mm  
OD: 0.691" / 17.55mm

### Control Valve Inner O-Ring

**Denso** 5SE09C, 7SBU17C

### Suction Port O-Ring

**Sanden** TR70

### Temperature Sensor O-Ring

**Mitsubishi** MSC90, MSC90C

### Tube-O Valve / Rotolock Adapter O-Ring

**York** 206, 209, 210

### Tube-O Valve O-Ring

**Tecumseh** HG1000, HG850

### **M96-1033** **Black Nitrile**

Alternate: M96-2133 (Green HNBR)

ID: 0.546" / 13.87mm  
OD: 0.824" / 20.93mm

### Carbon Shaft Seal O-Ring (for O.E. Seal)

**Denso** 10P13 Series, 10P15 Series

### **M96-1034** **Black Nitrile**

Alternate: M96-2134 (Green HNBR)

ID: 0.549" / 13.94mm  
OD: 0.755" / 19.18mm

### Carbon Shaft Seal O-Ring

**Chrysler** A590, C171

**Denso** 10P08E, 10P13 Series, 10P15 Series, 10P17 Series, 10PA15A, 10PA15C, 10PA15E, 10PA15LC, 10PA15SC, 10PA17A, 10PA17C, 10PA17E, 10PA17H, 10PA17J, 10PA17K, 10PA17SC, 10PA17SH, 6E171, 6E171A, 6P Series

## O-Rings and Lathe Cuts

### Carbon Shaft Seal O-Ring

**Diesel Kiki** DKS13G (DUAL), DKS13G (SINGLE), DKS13S, DKS15BH, DKS15G, DKS15S, DKS17G (DUAL), DKS17G (SINGLE)

**Ford** FS6, FS6 CROSS MOUNT

**GM/Harrison** A6, R4

**Nihon** DKV14C

**Sanden** SD507, SD507A2, SD508, SD510

**Seiko-Seiki** SS170PSS

### Crossover O-Ring

**Hitachi** A5000

### Suction Port O-Ring

**Mitsubishi** FX80

### M96-1037 Black Nitrile

Alternate: M96-2137 (Green HNBR)

ID: 0.614" / 15.60mm

OD: 0.754" / 19.15mm

### Control Valve O-Ring (Outer)

**Mitsubishi** FX105V

### Internal Bellows Plunger O-Ring

**Diesel Kiki** DCV11A, DCV14A, DKV11A

### Short Control Valve O-Ring (Outer)

**Chrysler** 6C17

### Suction / Discharge Port O-Ring

**Mats/Pan** N1300AC4, N1301AB4, N1301AD4, N1301AE4, NL1300AA4, NL1300AB4, NL1300AE4, SA1150AE4

### M96-1038 Black Nitrile

Alternate: M96-2138 (Green HNBR)

ID: 0.612" / 15.54mm

OD: 0.818" / 20.78mm

### Carbon Shaft Seal O-Ring

**Diesel Kiki** DKS16H(R12)

### Control Valve Plunger O-Ring (Center)

**Denso** 10PA15VC, 10PA15VL, 10PA17VC, 10PA17VL, 10PA17VSC

### Pad Mount Discharge O-Ring

**Sanden** SD505, SD507, SD507A2, SD508, SD510

### Sensor O-Ring

**Mitsubishi** FX105V

### Suction Port O-Ring

**Hitachi** MJ110, MJ123, MJS130

**Keihin** 150L, 150R

### Suction Port O-Ring (SWP167)

**Hitachi** SWP167

### Suction/Discharge Port O-Ring

**Hitachi** MJ167

### M96-1040 Black Nitrile

Alternate: M96-2140 (Green HNBR)

ID: 0.674" / 17.12mm

OD: 0.880" / 22.35mm

### Carbon Shaft Seal O-Ring

**Behr** WINGCELL

**Nihon** DKV14B

### Control Valve O-Ring (Outside)

**Calsonic** CWV615, CWV617, CWV618, V5-15C, V5-15F, V5-15G

**Daewoo** V5

**Delphi** CVC-125, CVC-135, CVC-165, CVC-185, CVC6, CVC7P

**GM/Harrison** V5, V5 (DESTROKER), V7

### Control Valve Outer O-Ring

**Calsonic** CSV613

### Discharge Port O-Ring

**Diesel Kiki** DKS13G (DUAL), DKS13G (SINGLE), DKS15BH, DKS15CH, DKS15G, DKS17CH, DKS17G (DUAL), DKS17G (SINGLE)

**Sanden** TR090, TR105, TR105VS, TRF090, TRF105, TRS090, TRS105

### Discharge Port O-Ring (TRSA12)

**Sanden** TRSA12

### M96-1041 Black Nitrile

Alternate: M96-2141 (Green HNBR)

ID: 0.676" / 17.17mm

OD: 0.816" / 20.73mm

### Control Valve Middle O-Ring

**Calsonic** CSV613

### Control Valve O-Ring (Outside Center)

**Calsonic** CWV615, CWV617, CWV618, V5-15C, V5-15F, V5-15G

**Daewoo** V5

**Delphi** CVC-125, CVC-135, CVC-165, CVC-185, CVC6, CVC7P

**GM/Harrison** V5, V5 (DESTROKER), V7

### Control Valve Outer O-Ring

**Mitsubishi** AX105VSR, FXA105VS, FXA105VSLR, FXA105VSR, FXA105VSSS

### Expansion Valve O-Ring (Lower)

**GM/Harrison** VIR

### Temperature Switch Dust Shield O-Ring

**Denso** TV12EC(R12), TV12SC(R134), TV14EC, TV14SC

### M96-1044 Black Nitrile

Alternate: M96-2144 (Green HNBR)

ID: 0.796" / 20.22mm

OD: 1.074" / 27.28mm

### Rear Head Sensor Port O-Ring

**Denso** 10PA15C

### Suction / Discharge Port O-Ring

**Calsonic** V5-15C, V5-15F, V5-15G

**Daewoo** V5

**Ford** FS10, FX15, LARGE

SCROLL

**GM/Harrison** A6, DA6, HR6, HR6HE, R4, V5, V5 (DESTROKER)

**Sanden** SD7H15

**Seiko-Seiki** SS170PSS

### M96-1046 Black Nitrile

Alternate: M96-2146 (Green HNBR)

ID: 0.801" / 20.35mm

OD: 0.941" / 23.90mm

### Bellows Adjustment Screw O-Ring

**Diesel Kiki** DCV14J, DKV11G, DKV14G, DKV14J

### Suction / Discharge Port O-Ring

**Sanden** SD7V16

### M96-1048 Black Nitrile

Alternate: M96-2148 (Green HNBR)

ID: 0.862" / 21.89mm

OD: 1.068" / 27.13mm

### Shaft Seal Seat O-Ring

**Diesel Kiki** DKS13S, DKS15S, DKS17S

**Sanden** SD708, SD709

### Switch Port O-Ring

**Chrysler** 6C17

**Daewoo** V5

**Ford** SCROLL

**GM/Harrison** A6, DA6, HD6, HR6, HR6HE, HT6, HU6, R4, V5, V5 (DESTROKER)

### M96-1051 Black Nitrile

Alternate: M96-2151 (Green HNBR)

ID: 0.239" / 6.07mm

OD: 0.367" / 9.32mm

### Control Valve Plunger O-Ring (Top)

**Denso** 10PA15VC, 10PA15VL, 10PA17VC, 10PA17VL, 10PA17VSC

### Head Bolt O-Ring, Front

**Sanden** TRSA09, TRSA12, TRSE07

### Oil Drain Plug O-Ring

**Sanden** TR090, TR105, TR105VS, TR70, TRF090, TRF105, TRS090, TRS105

### Rear Housing O-Ring

**Mitsubishi** FX105V, FX80

### M96-1052 Black Nitrile

Alternate: M96-2152 (Green HNBR)

ID: 0.924" / 23.47mm

OD: 1.130" / 28.70mm

### Service Valve O-Ring

**Chrysler** RV2

### M96-1053 Black Nitrile

Alternate: M96-2153 (Green HNBR)

ID: 0.737" / 18.72mm

OD: 0.943" / 23.95mm

### Control Valve O-Ring

**Sanden** PXV16, SD7V16

### Lip Seal O-Ring

**Mitsubishi** AX105VSR, FX105V, FX80, FXA105VS, FXA105VSLR, FXA105VSR, FXA105VSSS, MSC105CVS, MSC105VSR, MSC90, MSC90C

## O-Rings and Lathe Cuts

### Lip Seal O-Ring

**Sanden** TR090, TR105, TR105VS,  
TR70, TRF090, TRF105, TRS090,  
TRS105

### Pad Mount Suction O-Ring

**Sanden** SD505, SD507, SD507A2,  
SD508, SD510

### Rear Head Sensor Port O-Ring (for C20-2000) (Lexus)

**Denso** 10PA20C

### Rear Head Sensor Port O-Ring (for C20-2000) (Mercedes)

**Denso** 10PA15C, 10PA15SC,  
10PA17C

### Suc/Disch Port (All) / Rear Sensor Port (10P15C) O-Ring

**Denso** 10P13 Series, 10P15 Series

### Suction / Discharge Port O-Ring

**Ford** FS6, FS6 CROSS MOUNT

### Suction / Discharge Port O-Ring (Factory Hose Assembly)

**Denso** 10P08E, 10P17 Series,  
6E171, 6E171A, 6P Series

### **M96-1058** Black Nitrile

Alternate: M96-2158 (Green HNBR)

ID: 0.185" / 4.70mm  
OD: 0.297" / 7.54mm

### Liquid Bleed Line O-Ring

**GM/Harrison** VIR

### **A12-1110** Green HNBR

Oval Cross-Section O-Ring

ID: 0.748" / 19.00mm  
OD: 0.964" / 24.49mm  
Thick: 0.143" / 3.63mm

### Eccentric Oval O-Ring

**Denso** SC08 (ITALY), SC08C  
(SPAIN), SC08C (USA)

### Suction / Discharge Port Oval O-Ring (X-Mount/Tangent only)

**Ford** FS6 CROSS MOUNT

### **A13-1110** Green HNBR

Oval Cross-Section O-Ring

ID: 0.906" / 23.01mm  
OD: 1.110" / 28.19mm  
Thick: 0.138" / 3.51mm

### Suction / Discharge Port Oval O-Ring

**Calsonic** V5-15C, V5-15F, V5-15G

**Daewoo** V5

**GM/Harrison** DA6, HR6, HR6HE, R4, V5,  
V5 (DESTROKER)

### **G20-3112** Green HNBR

Suction/Discharge O-Ring w/Tabs (Mercedes)

ID: 0.776" / 19.71mm  
OD: 0.972" / 24.69mm

### Suction/Discharge O-Ring w/Tabs

**Denso** 6CA17C

### Suction/Discharge O-Ring w/Tabs (Mercedes)

**Denso** 10PA15C, 10PA15SC

### **M10-2102** Green HNBR

Alternate: M10-1002 (Black Nitrile)

ID: 0.276" / 7.01mm  
OD: 0.394" / 10.01mm

### Oil Drain Plug O-Ring

**Ford** SCROLL

**Sanden** SD7V16

### Rear Bolt O-Ring

**Mitsubishi** AX105VSR, FXA105VS,  
FXA105VSLR, FXA105VSR,  
FXA105VSSS

### **M10-2110** Green HNBR

Alternate: M10-1010 (Black Nitrile)

ID: 0.563" / 14.30mm  
OD: 0.751" / 19.08mm

### Carbon Shaft Seal O-Ring

**Hitachi** A5000, SWP123, SWP167

### Suction Port O-Ring (use with G11-2165)

**Denso** 10S15C, 10S15L, 10S17C,  
10S20C, 10S20F

### **M11-2101** Green HNBR

Alternate: M11-1001 (Black Nitrile)

ID: 0.859" / 21.82mm  
OD: 1.137" / 28.88mm

### Suction / Discharge Port O-Ring (Optional)

**GM/Harrison** R4

**Visteon** VS16

### **M11-2102** Green HNBR

Alternate: M11-1002 (Black Nitrile)

ID: 0.921" / 23.39mm  
OD: 1.199" / 30.45mm

### Shaft Seal Seat O-Ring

**Chrysler** A590, C171

**Ford** FS6, FS6 CROSS MOUNT

### **M11-2105** Green HNBR

Alternate: M11-1005 (Black Nitrile)

ID: 0.755" / 19.18mm  
OD: 0.949" / 24.10mm

### Shaft Seal Seat O-Ring

**Mats/Pan** N1300AC4, N1301AB4,  
N1301AD4, N1301AE4, NL1300AA4,  
NL1300AB4, NL1300AE4, S1150F3,  
S1150X3, SA1150AE4

### Suction / Discharge Port O-Ring (Aftermarket Hose Assembly)

**Denso** 10P08E, 10P13 Series,  
10P15 Series, 10P17C, 6E171, 6E171A,  
6P Series

**Ford** FS6

### **M11-2106** Green HNBR

Alternate: M11-1006 (Black Nitrile)

ID: 0.739" / 18.77mm  
OD: 0.879" / 22.33mm

### Control Valve O-Ring

**Diesel Kiki** DCW17B, DCW17D

### Control Valve O-Ring (Outer)

**Zexel** DCS17E

### Control Valve Seat O-Ring

**Denso** 6CA17C

### Long Control Valve Seat O-Ring

**Chrysler** 6C17

### Plug O-Ring (TRSE07)

**Sanden** TRSE07

### **M11-2110** Green HNBR

ID: 4.882" / 124.00mm  
OD: 5.040" / 128.02mm

### Case O-Ring

**Calsonic** CWV615, CWV617,

**Chrysler** 6C17

### Case O-Ring (Front)

**Mitsubishi** MSC130CVSG2

### **M11-2111** Green HNBR

ID: 0.453" / 11.51mm  
OD: 0.633" / 16.08mm

### Control Valve Outer O-Ring

**Ford** F500

### Suction Port O-Ring (use with G11-2165)

**Denso** 10S15C, 10S15L, 10S17C,  
10S20C, 10S20F

### **M12-2103** Green HNBR

Alternate: M12-1003 (Black Nitrile)

ID: 0.266" / 6.76mm  
OD: 0.406" / 10.31mm

### Oil Drain Plug O-Ring

**Delphi** CVC-125, CVC-135, CVC-  
135E, CVC6

### **M12-2114** Green HNBR

Alternate: M12-1014 (Black Nitrile)

ID: 3.987" / 101.27mm  
OD: 4.193" / 106.50mm

### Case O-Ring

**Ford** FS10, FS18, FX15

**GM/Harrison** DA6, HR6, HR6HE

**Nihon** DKV14B

**Visteon** HS15, HS17, HS18

### Case O-Ring (Front/Rear & Center [HD6, Early HT6])

**GM/Harrison** HD6, HT6

### Case O-Ring (Front/Rear)

**GM/Harrison** HU6

### **M13-2101** Green HNBR

Alternate: M13-1001 (Black Nitrile)

ID: 1.220" / 30.99mm  
OD: 1.464" / 37.19mm

### Lip Seal O-Ring (Large)

**GM/Harrison** HU6

### Lip Seal O-Ring (Large) (Late)

**GM/Harrison** HD6, HT6

## O-Rings and Lathe Cuts

### M13-2102 Green HNBR

Alternate: M13-1002 (Black Nitrile)

ID: 0.487" / 12.37mm  
OD: 0.693" / 17.60mm

Crossover O-Ring

**Hitachi** SWP123, SWP167

Rotor Ring O-Ring

**Mats/Pan** S1150AE4, S1150F3,  
S1150X3

### M13-2103 Green HNBR

Alternate: M13-1003 (Black Nitrile)

ID: 1.049" / 26.64mm  
OD: 1.255" / 31.88mm

Screen O-Ring

**Sanden** PXE16

Shaft Seal Seat O-Ring

**Behr** WINGCELL  
**Keihin** 150L, 150R  
**Nihon** DKV14B

Suction Screen O-Ring

**Sanden** PXE13

Superheat Adapter O-Ring (Beveled)

**GM/Harrison** A6

### M13-2104 Green HNBR

Alternate: M13-1004 (Black Nitrile)

ID: 1.237" / 31.42mm  
OD: 1.443" / 36.65mm

Lip Seal O-Ring

**Calsonic** V5-15C, V5-15F, V5-15G  
**GM/Harrison** DA6, HR6, HR6HE, V5, V5  
(DESTROKER)

Lip Seal O-Ring (Small)(Early)

**GM/Harrison** HD6, HT6, HU6

Shaft Seal Seat O-Ring

**Diesel Kiki** DKS16H(R12)  
**GM/Harrison** A6, R4

### M13-2107 Green HNBR

Alternate: M13-1007 (Black Nitrile)

ID: 4.237" / 107.62mm  
OD: 4.443" / 112.85mm

Case O-Ring

**Behr** WINGCELL  
**GM/Harrison** A6  
**Nihon** DKV14C, NVR140S

Case O-Ring (Center [Late HT6])

**GM/Harrison** HT6

Case O-Ring (Center)

**GM/Harrison** HU6

### M13-2108 Green HNBR

Alternate: M13-1008 (Black Nitrile)

ID: 4.487" / 113.97mm  
OD: 4.693" / 119.20mm

Case O-Ring

**Denso** 10P17 Series  
**GM/Harrison** V5, V5 (DESTROKER), V7

### M13-2109 Green HNBR

Alternate: M13-1009 (Black Nitrile)

ID: 1.239" / 31.47mm  
OD: 1.379" / 35.03mm

POA Valve O-Ring

**GM/Harrison** VIR

### M13-2111 Green HNBR

Alternate: M13-1011 (Black Nitrile)

ID: 0.989" / 25.12mm  
OD: 1.129" / 28.68mm

Expansion Valve O-Ring (Upper & Center)

**GM/Harrison** VIR

Superheat Adapter O-Ring (Captive)

**GM/Harrison** A6

### M13-2113 Green HNBR

Alternate: M13-1013 (Black Nitrile)

ID: 1.114" / 28.30mm  
OD: 1.254" / 31.85mm

Rotor Body Housing O-Ring (Front)

**Nihon** DKV14C

### M13-2114 Green HNBR

Alternate: M13-1014 (Black Nitrile)

ID: 5.984" / 151.99mm  
OD: 6.262" / 159.05mm

Case O-Ring

**GM/Harrison** R4

### M20-2115 Green HNBR

Alternate: M20-1015 (Black Nitrile)

ID: 0.906" / 23.01mm  
OD: 1.064" / 27.03mm

Adapter O-Ring

**Denso** TV12C(R12), TV12C(R134),  
TV12SC(R134), TV14C, TV14SC

Control Valve (4 O-Ring) Inner O-Ring

**Denso** 6SEU16

Control Valve Inner O-Ring

**Denso** 6SEU12, 6SEU12C,  
6SEU14C

Control Valve Outer O-Ring

**Denso** 5SE09C, 5SE12C, 7SBU17C,  
7SEU16, 7SEU17C

Internal Valve Plate O-Ring

**Denso** 6P127A, 6P127B, 6P127D

Valve Plate O-Ring

**Denso** 10P13 Series, 10P15 Series

### M20-2116 Green HNBR

Alternate: M20-1016 (Black Nitrile)

ID: 0.591" / 15.01mm  
OD: 0.787" / 19.99mm

Body Sensor Port O-Ring

**Denso** 10P13C, 10P15C, 10P17C,  
10PA15C, 10PA15SC, 10PA17C,  
10PA17SC, 10PA17SH, 10PA17VC,  
10PA17VSC, 10PA20C, 10PA20SC,  
10S15C, 10S15L, 10S17C, 10S20C,  
10S20F, 10S20H

Bottom/Side Switch O-Ring

**Denso** 10PA17VL

Carbon Shaft Seal O-Ring

**Hitachi** MJ110, MJ123, MJ167,  
MJS130, MJS170

Control Valve Middle O-Ring

**Denso** 5SE09C, 5SE12C, 7SBU17C

Suction and Discharge Port O-Ring (DNI)

**Seiko-Seiki** SS121DN1

### M20-2118 Green HNBR

Alternate: M20-1018 (Black Nitrile)

ID: 0.984" / 24.99mm  
OD: 1.220" / 30.99mm

Lip Seal O-Ring

**Calsonic** CWV615, CWV617,

**Chrysler** 6C17

**Denso** 10PA20C, 10PA20H,  
10PA20J, 10PA20SC, 10PA20SH,  
10PA20VC

**Diesel Kiki** DKS16H(R134A)

**GM/Harrison** V7

Shaft Seal Seat (Pre 1992) / Lip Seal O-Ring

**Denso** 10P08E

Shaft Seal Seat / Lip Seal O-Ring

**Denso** 10PA15 Series, 10PA17 Series

Shaft Seal Seat O-Ring

**Denso** 10P17 Series, 6E171,  
6E171A, 6P Series, TV10 Series,  
TV12C(R12), TV12EC(R12), TV14C,  
TV14EC

Shaft Seal Seat O-Ring (Use on S11-3101 only)

**Chrysler** A590, C171

**Ford** FS6, FS6 CROSS MOUNT

Shaft Seal Seat/Lip Seal O-Ring

**Denso** 10P13 Series, 10P15 Series

**Seiko-Seiki** SS170PSS

### M20-2119 Green HNBR

ID: 0.610" / 15.49mm  
OD: 0.768" / 19.51mm

Control Valve (4 O-Ring) Outer Middle O-Ring

**Denso** 6SEU16

Control Valve Inner Center O-Ring

**Denso** 7SEU16

Control Valve Inner Middle O-Ring

**Denso** 7SEU17C

Control Valve Inner O-Ring

**Sanden** PXE13, PXE16, SD7C16

Control Valve O-Ring (Large)

**Denso** TV12EC(R12),  
TV12SC(R134), TV14EC, TV14SC

Control Valve Outer Center O-Ring

**Denso** 6SEU12

Control Valve Outer Middle O-Ring

**Denso** 6SEU12C, 6SEU14C

Speed Sensor O-Ring (on VSSS unit only)

**Mitsubishi** FXA105VSSS



## O-Rings and Lathe Cuts

### M20-2125 Green HNBR

ID: 0.551" / 14.00mm  
OD: 0.747" / 18.97mm

#### Carbon Shaft Seal O-Ring

**Denso** TV10 Series  
**Sanden** SD708, SD709

### M20-2126 Green HNBR

ID: 2.874" / 73.00mm  
OD: 3.056" / 77.62mm

#### Case O-Ring

**Denso** TV10 Series

### M20-2130 Green HNBR

ID: 3.268" / 83.01mm  
OD: 3.464" / 87.99mm

#### Case O-Ring

**Denso** TV12 Series, TV14 Series

### M20-2131 Green HNBR

ID: 0.512" / 13.00mm  
OD: 0.670" / 17.02mm

#### Control Valve (4 O-Ring) Inner Middle O-Ring

**Denso** 6SEU16

#### Control Valve Inner Center O-Ring

**Denso** 6SEU12

#### Control Valve Inner Middle O-Ring

**Denso** 6SEU12C, 6SEU14C

#### Control Valve Inner O-Ring

**Denso** 7SEU16, 7SEU17C

#### Sensor O-Ring

**Denso** TV12C(R12), TV12EC(R12),  
TV12SC(R134), TV14 Series

#### Temperature Switch Dust Shield O-Ring

**Denso** TV10 Series

#### Temperature Switch O-Ring

**Denso** SC08C (USA)  
**Mitsubishi** MSC105CVS

### M20-2132 Green HNBR

Alternate: M20-1032 (Black Nitrile)

ID: 0.551" / 14.00mm  
OD: 0.709" / 18.01mm

#### Control Valve Inner Middle O-Ring

**Denso** 5SE09C, 5SE12C, 7SBU17C

#### Control Valve Inner O-Ring

**Denso** 7SE16

#### Temperature Switch Block O-Ring

**Denso** TV10 Series, TV12 Series,  
TV14 Series

### M20-2133 Green HNBR

ID: 0.630" / 16.00mm  
OD: 0.812" / 20.62mm

#### Carbon Shaft Seal O-Ring

**Denso** TV12C(R12), TV12EC(R12),  
TV14C, TV14EC

**Keihin** 150L, 150R

#### Control Valve (7 O-Ring) O-Ring 5

**Denso** 6SEU16

#### Discharge Manifold O-Ring

**Bosch** AXIAL

#### Rear Bellows Plunger O-Ring

**Diesel Kiki** DCV11A, DCV14A, DKV11A

#### Sensor O-Ring

**Mitsubishi** FX80

#### Suction / Discharge Port O-Ring

**Chrysler** A590, C171

**Visteon** HS17, HS18

### M20-2135 Green HNBR

Alternate: M20-1035 (Black Nitrile)

ID: 4.134" / 105.00mm  
OD: 4.330" / 109.98mm

#### Case O-Ring

**Calsonic** CSV613

**Delphi** CVC-125, CVC6

**Denso** 10P13 Series, 10P15 Series

#### Case O-Ring (Front and Rear)

**Diesel Kiki** DKS15CH

### M20-2140 Green HNBR

Alternate: M20-1040 (Black Nitrile)

ID: 4.252" / 108.00mm  
OD: 4.488" / 114.00mm

#### Case O-Ring

**Denso** 10PA15 Series, 10PA17  
Series, 6P127A, 6P127B, 6P127D, 6P148,  
6P148A, 6P148C

#### Case O-Ring (Front)

**Calsonic** CR14

#### Case O-Ring (Front) (TRSE07/TRSA09)

**Sanden** TRSA09, TRSE07

### M20-2158 Green HNBR

Alternate: M20-1058 (Black Nitrile)

#### Case O-Ring

ID: 4.528" / 115.01mm  
OD: 4.686" / 119.02mm

#### Case O-Ring

**Denso** 6CA17C, 6P134

**Hitachi** MJS170

**Mitsubishi** AX105VSR, FXA105VS,  
FXA105VSLR, FXA105VSR,  
FXA105VSSS

**Sanden** SD7C16, SD7V16

#### Case O-Ring (Rear)

**Mitsubishi** MSC130CVSG,  
MSC130CVSG2

#### Rear Scroll Housing O-Ring

**Mitsubishi** FX105V

### M20-2159 Green HNBR

Alternate: M20-1059 (Black Nitrile)

ID: 4.488" / 114.00mm  
OD: 4.724" / 119.99mm

#### Case O-Ring

**Denso** 10PA20C, 10PA20H,  
10PA20J, 10PA20SC, 10PA20SH,  
10PA20VC

#### Case O-Ring (Center)

**Diesel Kiki** DKS15CH

#### Rear Scroll O-Ring

**Sanden** TR105, TR105VS, TRF105,  
TRS105

#### Rear Scroll O-Ring (TRSA12)

**Sanden** TRSA12

### M20-2160 Green HNBR

ID: 0.535" / 13.59mm  
OD: 0.723" / 18.36mm

#### Fitting (Refrigerant) - 1/8" NPT Brass Port w/ Valve O-Ring

**Denso** 10P13C, 10P13E, 10P13F,  
10P15 Series, 10P17 Series

#### Suction Port O-Ring (Jeep Only)

**Denso** 10S11P

#### Suction Port O-Ring (use with G11-2165) (Jeep Only)

**Denso** 10P13A, 10P13B

#### Suction Port O-Ring (use with G11-2166) (Jeep Only)

**Denso** 10S15C, 10S15L, 10S17C,  
10S20C, 10S20F

### M20-2162 Green HNBR

ID: 0.772" / 19.61mm  
OD: 0.960" / 24.38mm

#### Suction / Discharge O-Ring

**Sanden** SD709CP

#### Suction Manifold O-Ring

**Bosch** AXIAL

#### Temperature Switch O-Ring

**Denso** 6CA17C

**Mats/Pan** N1300AC4, N1301AB4,  
N1301AD4, N1301AE4, NL1300AA4,  
NL1300AB4, NL1300AE4, S1150F3,  
S1150X3, SA1150AE4

### M20-2163 Green HNBR

ID: 0.354" / 8.99mm  
OD: 0.472" / 11.99mm

#### Control Valve O-Ring (Inner)/Oil Drain Plug

**Zexel** DCS17E

#### Oil Drain Bolt O-Ring

**Sanden** PXE13, PXE16, SD7C16

**Zexel** DCS17IC

#### Pressure Release Valve O-Ring

**Mitsubishi** MSC90, MSC90C

## O-Rings and Lathe Cuts

### M20-2164 Green HNBR

ID: 0.669" / 16.99mm  
OD: 0.827" / 21.01mm

#### Control Valve Outer O-Ring

**Denso** 5SL12CJ, 5SL142, 7SBU16C  
**Zexel** DCS171C

### M20-2171 Green HNBR

Alternate: M20-1071 (Black Nitrile)

ID: 1.296" / 32.92mm  
OD: 1.574" / 39.98mm

#### Rear Head Sensor Port O-Ring

**Denso** 10PA15C

#### Rear Head Sensor Port O-Ring (For C20-2001-Toyota/Mercedes)

**Denso** 10P15C

#### Rotor O-Ring

**Behr** WINGCELL

### M25-2101 Green HNBR

Alternate: M25-1001 (Black Nitrile)

ID: 0.138" / 3.51mm  
OD: 0.256" / 6.50mm

#### Internal Orifice Tube O-Ring

**Ford** LARGE SCROLL

**Sanden** PXV16, SD7V16, TRSA09, TRSA12, TRSE07

### M25-2115 Green HNBR

ID: 3.504" / 89.00mm  
OD: 3.740" / 95.00mm

#### Nose Piece O-Ring

**Sanden** SD7B10

### M25-2117 Green HNBR

Alternate: M25-1017 (Black Nitrile)

ID: 1.161" / 29.49mm  
OD: 1.319" / 33.50mm

#### Internal Front Rotor Housing to Nose O-Ring

**Calsonic** DKV14D

**Diesel Kiki** DCV11A, DCV11D, DCV14A, DKV11A, DKV11D

#### Internal Rotor O-Ring

**Seiko-Seiki** SS170PSS

#### Rear Internal Screen Body O-Ring

**Seiko-Seiki** SS121DN1, SS121DN2, SS121DV2

#### Shaft Seal Seat O-Ring

**Sanden** SD507, SD507A2, SD508, SD510

### M30-2100 Green HNBR

Alternate: M30-1000 (Black Nitrile)

ID: 0.799" / 20.29mm  
OD: 1.005" / 25.53mm

#### Lip Seal / Suction Port O-Ring

**Diesel Kiki** DKS15CH, DKS17CH

#### Lip Seal O-Ring

**Delphi** SP10

**Denso** 6CA17C, 7SB16C

**Diesel Kiki** DKS13CH

**Hadsys** RC17D, RC17S

**Sanden** SD5H09, SD5H11, SD5H13, SD6V12, SD708, SD709, SD709CA, SD709CP, SD7B10, SD7H13, SD7H15, SD7V16

**Seiko-Seiki** SS121DN1, SS121DN2, SS121DV2

**Tama** TM08HD

#### Shaft Seal Seat O-Ring

**Mitsubishi** FX105V

**Sanden** SD505, TR70

#### Shaft Seal Seat O-Ring (Small)

**Nihon** DKV14C

#### Suction Port O-Ring

**Diesel Kiki** DKS13G (DUAL), DKS13G (SINGLE), DKS15BH, DKS15G, DKS17G (DUAL), DKS17G (SINGLE)

#### Suction Port O-Ring (TRSA12)

**Sanden** TRSA12

#### Suction Port O-Ring/Metal Shaft Seal O-Ring

**Sanden** TR105, TR105VS, TRF105, TRS105

#### Suction Port O-Ring/Shaft Seal Seat O-Ring

**Sanden** TR090, TRF090, TRS090

### M30-2101 Green HNBR

Alternate: M30-1001 (Black Nitrile)

ID: 0.987" / 25.07mm  
OD: 1.193" / 30.30mm

#### Shaft Seal Seat O-Ring

**Diesel Kiki** DKS13G (DUAL), DKS13G (SINGLE), DKS15BH, DKS15G, DKS15S, DKS17G (DUAL), DKS17G (SINGLE)

### M30-2120 Green HNBR

ID: 4.567" / 116.00mm  
OD: 4.763" / 120.98mm

#### Case O-Ring

**Calsonic** V5-15C, V5-15F, V5-15G

**Daewoo** V5

**Diesel Kiki** DKS16H(R12), DKS16H(R134A)

### M30-2121 Green HNBR

ID: 0.394" / 10.01mm  
OD: 0.590" / 14.99mm

#### Control Valve Outer O-Ring

**Denso** 6CA17C, 7SB16C

#### Oil Fill Plug O-Ring

**Diesel Kiki** DKS16H(R12), DKS16H(R134A)

#### Suction/Discharge Port O-Ring

**Hitachi** A5000, MJS170

### M30-2122 Green HNBR

ID: 0.315" / 8.00mm  
OD: 0.473" / 12.01mm

#### Control Valve Inner O-Ring

**Denso** 6CA17C, 7SB16C

#### Crossover O-Ring

**Bosch** AXIAL

#### Head Bolt O-Ring

**Diesel Kiki** DKS16H(R12), DKS16H(R134A)

#### Long Control Valve O-Ring (Inner)

**Chrysler** 6C17

#### Needle Valve O-Ring

**Denso** TV12EC(R12), TV12SC(R134), TV14EC, TV14SC

#### Pressure Relief Valve O-Ring

**Diesel Kiki** DKS15CH, DKS17CH

### M30-2125 Green HNBR

ID: 0.394" / 10.01mm  
OD: 0.552" / 14.02mm

#### Control Valve O-Ring (Small)

**Denso** TV12EC(R12), TV12SC(R134), TV14EC, TV14SC

#### Oil Drain Plug O-Ring

**Diesel Kiki** DKS15BH

#### Oil Fill Plug O-Ring

**Diesel Kiki** DKS13G (DUAL), DKS13G (SINGLE), DKS15G, DKS17G (DUAL), DKS17G (SINGLE)

#### Short Control Valve O-Ring (Inner)

**Chrysler** 6C17

### M30-2126 Green HNBR

ID: 4.488" / 114.00mm  
OD: 4.684" / 118.97mm

#### Case O-Ring

**Denso** SC08 (ITALY), SC08C (SPAIN), SC08C (USA)

#### Case O-Ring (Center)

**Diesel Kiki** DKS17CH

#### Case O-Ring (Front and Rear)

**Diesel Kiki** DKS17S

### M45-2101 Green HNBR

Alternate: M45-1001 (Black Nitrile)

ID: 0.709" / 18.01mm  
OD: 0.905" / 22.99mm

#### Carbon Seal Head O-Ring

**Nihon** NVR140S

### M45-2102 Green HNBR

Alternate: M45-1002 (Black Nitrile)

ID: 1.339" / 34.01mm  
OD: 1.497" / 38.02mm

#### Rear Rotor Body O-Ring

**Nihon** NVR140S

### M50-2101 Green HNBR

Alternate: M50-1001 (Black Nitrile)

ID: 3.307" / 84.00mm  
OD: 3.465" / 88.01mm

#### Case O-Ring

**Mats/Pan** N1300AC4, N1301AB4, N1301AD4, N1301AE4, NL1300AA4, NL1300AB4, NL1300AE4

## O-Rings and Lathe Cuts

### Rear Plate O-Ring

**Tecumseh** HG500  
**M50-2103** **Green HNBR**

Alternate: M50-1003 (Black Nitrile)  
 ID: 0.591" / 15.01mm  
 OD: 0.709" / 18.01mm

### Control Valve Middle O-Ring

**Mitsubishi** AX105VSR, FXA105VS,  
 FXA105VSLR, FXA105VSR,  
 FXA105VSSS

**Zexel** DCS17E

### Discharge Housing O-Ring

**Mats/Pan** H12A1AH4DX, N1300AC4,  
 N1301AB4, N1301AD4, N1301AE4,  
 NL1300AA4, NL1300AB4, NL1300AE4

### Rear Housing Body O-Ring

**Mitsubishi** FX105V

**M50-2104** **Green HNBR**

Alternate: M50-1004 (Black Nitrile)  
 ID: 0.531" / 13.49mm  
 OD: 0.727" / 18.47mm

### Front Head Switch O-Ring

**Mats/Pan** N1300AC4, NL1300AA4,  
 NL1300AB4, NL1300AE4

**M50-2105** **Green HNBR**

Alternate: M50-1005 (Black Nitrile)  
 ID: 0.492" / 12.50mm  
 OD: 0.688" / 17.48mm

### Carbon Shaft Seal O-Ring

**Mats/Pan** N1300AC4, N1301AB4,  
 N1301AD4, N1301AE4, NL1300AA4,  
 NL1300AB4, NL1300AE4, S1150F3,  
 S1150X3, SA1150AE4

### O-Ring - Temperature Switch

**Mitsubishi** MSC130CVSG,  
 MSC130CVSG2

**M50-2107** **Green HNBR**

ID: 0.673" / 17.09mm  
 OD: 0.783" / 19.89mm

### Discharge Housing O-Ring

**Mats/Pan** SA1150AE4

### Temperature Switch Dust Shield O-Ring

**Denso** TV10 Series, TV12 Series,  
 TV14 Series

**M50-2110** **Green HNBR**

ID: 0.512" / 13.00mm  
 OD: 0.630" / 16.00mm

### Discharge Housing O-Ring

**Mats/Pan** S1150F3, S1150X3

### Rear Housing Relief Port O-Ring

**Mitsubishi** MSC105CVS

**M50-2112** **Green HNBR**

Alternate: M50-1012 (Black Nitrile)  
 ID: 2.992" / 76.00mm  
 OD: 3.150" / 80.01mm

### Case O-Ring

**Mats/Pan** SA1150AE4

### Rotor Housing O-Ring

**Mats/Pan** H12A1AH4DX

### Rotor O-Ring (Front and Rear)

**Mats/Pan** S1150F3, S1150X3

**M55-2101** **Green HNBR**

ID: 4.016" / 102.01mm  
 OD: 4.252" / 108.00mm

### Case O-Ring - Rear

**Visteon** HS090L, HS090R, HS110R

### Case O-Ring (Rear)

**Calsonic** CR14

### Rear Scroll O-Ring

**Mitsubishi** FX80

**Sanden** TR090, TRF090, TRS090

### Rear Scroll O-Ring (TRSE07/TRSA09)

**Sanden** TRSA09, TRSE07

### Rear Stationary Scroll O-Ring

**Ford** LARGE SCROLL, SCROLL

**M55-2102** **Green HNBR**

ID: 4.134" / 105.00mm  
 OD: 4.292" / 109.02mm

### Case O-Ring

**Bosch** AXIAL

**Delphi** CVC-135, CVC-135E, SP15

**Mitsubishi** FX80

**Sanden** SD6V12

### Case O-Ring (Rear)

**Mitsubishi** MSC105CVS

### Front Nose O-Ring

**Sanden** TR090, TRF090, TRS090

### Outer Valve Plate O-Ring

**Hitachi** MJ110, MJ123, MJ167,  
 MJS130

### Rear Scroll O-Ring

**Mitsubishi** MSC90, MSC90C

**M55-2103** **Green HNBR**

Alternate: M55-1003 (Black Nitrile)

ID: 3.489" / 88.62mm  
 OD: 3.629" / 92.18mm

### Nose Plate O-Ring

**Mitsubishi** FX105V

**M60-2100** **Green HNBR**

Alternate: M60-1000 (Black Nitrile)

ID: 5.239" / 133.07mm  
 OD: 5.379" / 136.63mm

### Case O-Ring (Outer)

**Keihin** 150L

**M65-2101** **Green HNBR**

ID: 0.575" / 14.61mm  
 OD: 0.763" / 19.38mm

### Rear Head Plate O-Ring

**Denso** 10PA15VC, 10PA17VC,  
 10PA17VSC

**M65-2105** **Green HNBR**

Alternate: M65-1005 (Black Nitrile)

ID: 0.236" / 5.99mm  
 OD: 0.394" / 10.01mm

### Oil Drain Plug O-Ring

**Bosch** AXIAL

**Delphi** CVC-165, CVC-185, CVC7P

### Pickup Tube O-Ring

**Hitachi** SWP123, SWP167

**M65-2106** **Green HNBR**

Alternate: M65-1006 (Black Nitrile)

ID: 0.630" / 16.00mm  
 OD: 0.788" / 20.02mm

### Control Valve (7 O-Ring) O-Ring 4

**Denso** 6SEU16

### Control Valve Middle O-Ring

**Denso** 7SE16

### Speed Sensor O-Ring

**Diesel Kiki** DCW17B, DCW17D

**M65-2115** **Green HNBR**

Alternate: M65-1015 (Black Nitrile)

ID: 0.472" / 11.99mm  
 OD: 0.668" / 16.97mm

### Carbon Shaft Seal O-Ring

**Mitsubishi** FX105V

**Sanden** SD505, TR090, TR105,  
 TR105VS, TR70, TRF090, TRF105,  
 TRS090, TRS105

### Crossover Tube O-Ring

**Hitachi** A5000, MJ110, MJ123,  
 MJ167, MJS130, MJS170

**M65-2133** **Green HNBR**

Alternate: M65-1033 (Black Nitrile)

ID: 4.016" / 102.01mm  
 OD: 4.174" / 106.02mm

### Case O-Ring

**Delphi** SP10

### Case O-Ring - Front

**Visteon** HS090L, HS090R, HS110R

### Case O-Ring (Inner)

**Keihin** 150L, 150R

**M65-2135** **Green HNBR**

Alternate: M65-1035 (Black Nitrile)

### Case O-Ring

ID: 4.291" / 108.99mm  
 OD: 4.449" / 113.00mm

### Case O-Ring

**Diesel Kiki** DKS13G (DUAL), DKS13G  
 (SINGLE), DKS13S, DKS15BH,  
 DKS15G, DKS15S

**Hitachi** A5000

**Mitsubishi** MSC90, MSC90C

**Sanden** SD709CA, TR70

**Tama** TM08HD

### Case O-Ring (Front)

**Mitsubishi** MSC105CVS

## O-Rings and Lathe Cuts

### Case O-Ring (Rear)

**Hitachi** MJ110, MJ123, MJ167,  
MJS130, SWP123, SWP167

### Front Case O-Ring

**Ford** LARGE SCROLL, SCROLL

### Outer Valve Plate O-Ring

**Hitachi** MJS170

### Rear Scroll O-Ring

**Mitsubishi** AX105VSR, FXA105VS,  
FXA105VSLR, FXA105VSR,  
FXA105VSSS

### **M94-2102** **Green HNBR**

Alternate: M94-1002 (Black Nitrile)

ID: 1.301" / 33.05mm  
OD: 1.441" / 36.60mm

### Control Valve Cover Gasket

**Ford** LARGE SCROLL

### Internal Front Housing to Nose O-Ring

**Diesel Kiki** DCV14J, DKV11G,  
DKV14G, DKV14J

### **M94-2184** **Green HNBR**

Alternate: M94-1084 (Black Nitrile)

ID: 0.644" / 16.36mm  
OD: 0.818" / 20.78mm

### Bellows O-Ring

**Diesel Kiki** DCV14J, DKV14J

### **M95-2101** **Green HNBR**

Alternate: M95-1001 (Black Nitrile)

ID: 0.709" / 18.01mm  
OD: 0.867" / 22.02mm

### Control Valve Seat O-Ring

**Denso** 7SB16C

### Suction Port O-Ring

**Behr** WINGCELL

### **M95-2105** **Green HNBR**

Alternate: M95-1005 (Black Nitrile)

ID: 0.551" / 14.00mm  
OD: 0.787" / 19.99mm

### Carbon Shaft Seal O-Ring

**Bosch** AXIAL

### **M95-2106** **Green HNBR**

Alternate: M95-1006 (Black Nitrile)

ID: 0.208" / 5.28mm  
OD: 0.348" / 8.84mm

### Discharge Reed Bolt O-Ring

**Diesel Kiki** DCV14J, DKV11G, DKV14G

### Discharge Reed Housing Bolt O-Ring

**Diesel Kiki** DKV14J

### Oil Pickup Tube O-Ring

**Bosch** AXIAL

### **M95-2107** **Green HNBR**

Alternate: M95-1007 (Black Nitrile)

ID: 0.864" / 21.95mm  
OD: 1.004" / 25.50mm

### Control Valve (7 O-Ring) O-Ring 6

**Denso** 6SEU16

### Discharge Manifold O-Ring

**Denso** SCSC06

### Discharge Port O-Ring

**Denso** SCS06C

### **M95-2108** **Green HNBR**

Alternate: M95-1008 (Black Nitrile)

ID: 1.364" / 34.65mm  
OD: 1.504" / 38.20mm

### Internal Head O-Ring

**Behr** WINGCELL

### Rotor Body Housing O-Ring (Rear)

**Nihon** DKV14C

### **M96-2102** **Green HNBR**

Alternate: M96-1002 (Black Nitrile)

ID: 0.239" / 6.07mm  
OD: 0.379" / 9.63mm

### Oil Drain Plug O-Ring

**Diesel Kiki** DKS16H(R12),  
DKS16H(R134A)

### Oil Pickup Tube O-Ring

**GM/Harrison** A6

### **M96-2104** **Green HNBR**

ID: 0.256" / 6.50mm  
OD: 0.378" / 9.60mm

### Oil Drain Plug O-Ring

**Diesel Kiki** DCV11A, DCV14A, DKV11A

### Rear Housing O-Ring

**Mitsubishi** AX105VSR, FXA105VS,  
FXA105VSLR, FXA105VSR,  
FXA105VSSS

### **M96-2106** **Green HNBR**

ID: 0.262" / 6.65mm  
OD: 0.468" / 11.89mm

### Outside Bolt Plug O-Ring

**Mitsubishi** AX105VSR, FXA105VS,  
FXA105VSLR, FXA105VSR,  
FXA105VSSS

### **M96-2109** **Green HNBR**

Alternate: M96-1009 (Black Nitrile)

ID: 0.301" / 7.65mm  
OD: 0.441" / 11.20mm

### Case Bolt O-Ring

**Mitsubishi** MSC105CVS, MSC90,  
MSC90C

### Condenser Line O-Ring / Pickup Tube O-Ring

**GM/Harrison** VIR

### Destroker Valve Plate O-Ring (Older Model)

**GM/Harrison** V5 (DESTROKER)

### Oil Drain Plug O-Ring

**Diesel Kiki** DKS13G (DUAL), DKS13G  
(SINGLE), DKS13S, DKS15CH,  
DKS15G, DKS15S, DKS17CH, DKS17G  
(DUAL), DKS17G (SINGLE), DKS17S

### Pressure Relief Valve/Oil Drain Plug O-Ring

**Diesel Kiki** DCW17B, DCW17D

### Service Port O-Ring

**Seiko-Seiki** SS170PSS

### Service Valve O-Ring

**Sanden** SD708, SD709, SD709CA

### **M96-2110** **Green HNBR**

Alternate: M96-1010 (Black Nitrile)

ID: 0.301" / 7.65mm  
OD: 0.429" / 10.90mm

### Discharge Crossover O-Ring

**GM/Harrison** DA6, HD6, HR6, HR6HE,  
HT6

### Rear Head Bolt O-Ring

**Mitsubishi** FX105V, FX80,  
MSC130CVSG, MSC130CVSG2

### **M96-2111** **Green HNBR**

ID: 0.315" / 8.00mm  
OD: 0.441" / 11.20mm

### Pressure Relief Valve O-Ring

**Mitsubishi** AX105VSR, FXA105VS,  
FXA105VSLR, FXA105VSR,  
FXA105VSSS

**Sanden** TRSA09, TRSA12, TRSE07

### **M96-2112** **Green HNBR**

ID: 0.315" / 8.00mm  
OD: 0.455" / 11.56mm

### Pressure Relief Valve O-Ring

**Mitsubishi** MSC130CVSG,  
MSC130CVSG2

**Sanden** PXE13, PXE16

**Visteon** VS16, VS18M

### **M96-2113** **Green HNBR**

ID: 0.331" / 8.41mm  
OD: 0.465" / 11.81mm

### Pressure Relief Valve O-Ring

**Diesel Kiki** DCV14J, DKS17D, DKV14J

### **M96-2114** **Green HNBR**

ID: 0.341" / 8.66mm  
OD: 0.459" / 11.66mm

### Oil Drain Plug O-Ring

**Sanden** PXV16, SD6V12

### Pressure Relief Valve O-Ring

**Calsonic** CR14

**Seiko-Seiki** SS121DN1, SS121DN2,  
SS121DV2

### Service Valve O-Ring

**Diesel Kiki** DCW17B, DCW17D

### **M96-2115** **Green HNBR**

Alternate: M96-1015 (Black Nitrile)

ID: 0.351" / 8.92mm  
OD: 0.495" / 12.57mm

### Pressure Relief Valve O-Ring

**Calsonic** DKV14D

**Diesel Kiki** DCV11A, DCV14A,  
DKV11A, DKV11G, DKV14G

## O-Rings and Lathe Cuts

**M96-2116 Green HNBR**

Alternate: M96-1016 (Black Nitrile)

ID: 0.362" / 9.19mm  
OD: 0.568" / 14.43mmLong Control Valve O-Ring (Outer)**Chrysler** 6C17Rear Housing Body O-Ring**Mitsubishi** FX80Suction/Discharge Port O-Ring**Nihon** DKV14C**M96-2117 Green HNBR**ID: 0.364" / 9.25mm  
OD: 0.554" / 14.07mmOil Drain Plug O-Ring**Tama** TM08HD**M96-2118 Green HNBR**

Alternate: M96-1018 (Black Nitrile)

ID: 0.364" / 9.25mm  
OD: 0.504" / 12.80mmControl Valve (Inner) / High PSI Relief Valve O-Ring**Calsonic** CWV615, CWV617,  
CWV618, V5-15C, V5-15F, V5-15G**Daewoo** V5**Delphi** CVC-125, CVC-135, CVC-165,  
CVC-185, CVC6, CVC7P**GM/Harrison** V5, V5 (DESTROKER), V7Control Valve Inner / High PSI Relief Valve O-Ring**Calsonic** CSV613Control Valve Mount / High PSI Relief Valve O-Ring**Denso** 10PA15VC, 10PA15VL,  
10PA17VC, 10PA17VL, 10PA17VSC,  
10S20HControl Valve O-Ring (Inner)**Mitsubishi** FX105VHead Bolt O-Ring, Rear**Sanden** TRSA09, TRSA12, TRSE07High Pressure Relief Valve O-Ring**Bosch** AXIAL**Chrysler** 6C17**Delphi** CVC-135E**Denso** 10S11C, 10S11P, 10S13C,  
10S13P, 10S15C, 10S15L, 10S17C,  
10S20C, 10S20F, 10SR15C, 10SR17C,  
5SE09C, 5SE12C, 6SEU12, 6SEU12C,  
6SEU14C, 6SEU16, 7SBU17C, 7SE16,  
7SEU16, 7SEU17C, SC08 (ITALY),  
SC08C (SPAIN), SCS06C, SCSA06,  
SCSC06, TV12C(R13)**Diesel Kiki** DKS13S, DKS15S**Ford** F500, FS18**GM/Harrison** A6, DA6, HD6, HR6,  
HR6HE, HT6, HU6, R4**Hadsys** RC17D, RC17S**Mats/Pan** H12A1AH4DX, N1301AB4,  
N1301AD4, N1301AE4, SA1150AE4**Mitsubishi** MSC105CVS**Sanden** PXV16, SD7B10, SD7V16,  
TR090, TR105, TR105VS, TRF090,  
TRF105, TRS090, TRS105**Visteon** HS15, HS17, HS18**Zexel** DCS17E, DCS17ICHigh Pressure Relief Valve O-Ring (HS090L/R)**Visteon** HS090L, HS090ROil Drain Plug / Service Port O-Ring**Sanden** SD505, SD507, SD507A2,  
SD508, SD510, SD5H09, SD5H11,  
SD5H13, SD7H13, SD7H15Oil Drain Plug O-Ring**Sanden** SD708, SD709**York** 206, 209, 210, SC206, SC209**M96-2121 Green HNBR**

Alternate: M96-1021 (Black Nitrile)

ID: 0.414" / 10.52mm  
OD: 0.558" / 14.17mmDischarge Port O-Ring**Calsonic** CR14**M96-2122 Green HNBR**

Alternate: M96-1022 (Black Nitrile)

ID: 0.424" / 10.77mm  
OD: 0.630" / 16.00mmDischarge Port O-Ring**Mitsubishi** FX80Pressure Relief Valve O-Ring**Seiko-Seiki** SS10LV6, SS10V1, SS10V6Sightglass O-Ring**GM/Harrison** VIR**M96-2123 Green HNBR**

Alternate: M96-1023 (Black Nitrile)

ID: 0.426" / 10.82mm  
OD: 0.566" / 14.38mmControl Valve O-Ring (Inside Center)**Calsonic** CWV615, CWV617,  
CWV618, V5-15C, V5-15F, V5-15G**Daewoo** V5**Delphi** CVC-125, CVC-135, CVC-165,  
CVC6, CVC7P**GM/Harrison** V5, V5 (DESTROKER), V7Discharge Port O-Ring**Sanden** TR70Evaporator Inlet Line Connection O-Ring**GM/Harrison** VIR**M96-2126 Green HNBR**

Alternate: M96-1026 (Black Nitrile)

ID: 0.433" / 11.00mm  
OD: 0.559" / 14.20mmControl Body O-Ring**Mitsubishi** MSC130CVSG,  
MSC130CVSG2**M96-2129 Green HNBR**

Alternate: M96-1029 (Black Nitrile)

ID: 0.489" / 12.42mm  
OD: 0.629" / 15.98mmControl Valve O-Ring (Center)**Mitsubishi** FX105V**M96-2130 Green HNBR**ID: 0.512" / 13.00mm  
OD: 0.638" / 16.21mmControl Valve Inner O-Ring**Delphi** CVC-135ERear Housing Body O-Ring**Mitsubishi** AX105VSR, FXA105VS,  
FXA105VSLR, FXA105VSR,  
FXA105VSSS**M96-2131 Green HNBR**ID: 0.528" / 13.41mm  
OD: 0.668" / 16.97mmControl Valve (7 O-Ring) O-Ring 1 (Inner / Smallest)**Denso** 6SEU16Suction Port O-Ring**Calsonic** CR14**M96-2132 Green HNBR**

Alternate: M96-1032 (Black Nitrile)

ID: 0.551" / 14.00mm  
OD: 0.691" / 17.55mmControl Valve (7 O-Ring) O-Ring 2**Denso** 6SEU16Control Valve Inner O-Ring**Denso** 5SE09C, 5SE12C, 7SBU17CSuction Port O-Ring**Sanden** TR70Temperature Sensor O-Ring**Mitsubishi** MSC90, MSC90CTube-O Valve / Rotolock Adapter O-Ring**York** 206, 209, 210Tube-O Valve O-Ring**Tecumseh** HG1000, HG850**M96-2133 Green HNBR**

Alternate: M96-1033 (Black Nitrile)

ID: 0.546" / 13.87mm  
OD: 0.824" / 20.93mmCarbon Shaft Seal O-Ring (for O.E. Seal)**Denso** 10P13 Series, 10P15 Series**M96-2134 Green HNBR**

Alternate: M96-1034 (Black Nitrile)

ID: 0.549" / 13.94mm  
OD: 0.755" / 19.18mmCarbon Shaft Seal O-Ring**Chrysler** A590, C171

## O-Rings and Lathe Cuts

### Carbon Shaft Seal O-Ring

**Denso** 10P08E, 10P13 Series,  
10P15 Series, 10P17 Series, 10PA15A,  
10PA15C, 10PA15E, 10PA15LC,  
10PA15SC, 10PA17A, 10PA17C,  
10PA17E, 10PA17H, 10PA17J, 10PA17K,  
10PA17SC, 10PA17SH, 6E171, 6E171A,  
6P Series

**Diesel Kiki** DKS13G (DUAL), DKS13G  
(SINGLE), DKS13S, DKS15BH,  
DKS15G, DKS15S, DKS17G (DUAL),  
DKS17G (SINGLE), DKS17S

**Ford** FS6, FS6 CROSS MOUNT

**GM/Harrison** A6, R4

**Nihon** DKV14C

**Sanden** SD507, SD507A2, SD508,  
SD510

**Seiko-Seiki** SS170PSS

### Crossover O-Ring

**Hitachi** A5000

### Suction Port O-Ring

**Mitsubishi** FX80

**M96-2137 Green HNBR**

Alternate: M96-1037 (Black Nitrile)

ID: 0.614" / 15.60mm  
OD: 0.754" / 19.15mm

### Control Valve (7 O-Ring) O-Ring 3

**Denso** 6SEU16

### Control Valve O-Ring (Outer)

**Mitsubishi** FX105V

### Internal Bellows Plunger O-Ring

**Diesel Kiki** DCV11A, DCV14A, DKV11A

### Short Control Valve O-Ring (Outer)

**Chrysler** 6C17

### Suction / Discharge Port O-Ring

**Mats/Pan** N1300AC4, N1301AB4,  
N1301AD4, N1301AE4, NL1300AA4,  
NL1300AB4, NL1300AE4, SA1150AE4

**M96-2138 Green HNBR**

Alternate: M96-1038 (Black Nitrile)

ID: 0.612" / 15.54mm  
OD: 0.818" / 20.78mm

### Carbon Shaft Seal O-Ring

**Diesel Kiki** DKS16H(R12)

### Control Valve Plunger O-Ring (Center)

**Denso** 10PA15VC, 10PA15VL,  
10PA17VC, 10PA17VL, 10PA17VSC

### Pad Mount Discharge O-Ring

**Sanden** SD505, SD507, SD507A2,  
SD508, SD510

### Sensor O-Ring

**Mitsubishi** FX105V

### Suction Port O-Ring

**Hitachi** MJ110, MJ123, MJS130

**Keihin** 150L, 150R

### Suction Port O-Ring (SWP167)

**Hitachi** SWP167

### Suction/Discharge Port O-Ring

**Hitachi** MJ167

**M96-2139 Green HNBR**

ID: 0.648" / 16.46mm  
OD: 0.788" / 20.02mm

### Control Valve Middle O-Ring

**Sanden** PXE13, PXE16, SD7C16

**M96-2140 Green HNBR**

Alternate: M96-1040 (Black Nitrile)

ID: 0.674" / 17.12mm  
OD: 0.880" / 22.35mm

### Carbon Shaft Seal O-Ring

**Behr** WINGCELL

**Nihon** DKV14B

### Control Valve O-Ring (Outside)

**Calsonic** CWV615, CWV617,  
CWV618, V5-15C, V5-15F, V5-15G

**Daewoo** V5

**Delphi** CVC-125, CVC-135, CVC-  
165, CVC-185, CVC6, CVC7P

**GM/Harrison** V5, V5 (DESTROKER), V7

### Control Valve Outer O-Ring

**Calsonic** CSV613

### Discharge Port O-Ring

**Diesel Kiki** DKS13G (DUAL), DKS13G  
(SINGLE), DKS15BH, DKS15CH,  
DKS15G, DKS17CH, DKS17G (DUAL),  
DKS17G (SINGLE)

**Sanden** TR090, TR105, TR105VS,  
TRF090, TRF105, TRS090, TRS105

### Discharge Port O-Ring (TRSA12)

**Sanden** TRSA12

**M96-2141 Green HNBR**

Alternate: M96-1041 (Black Nitrile)

ID: 0.676" / 17.17mm  
OD: 0.816" / 20.73mm

### Control Valve Middle O-Ring

**Calsonic** CSV613

### Control Valve O-Ring (Outside Center)

**Calsonic** CWV615, CWV617,  
CWV618, V5-15C, V5-15F, V5-15G

**Daewoo** V5

**Delphi** CVC-125, CVC-135, CVC-  
165, CVC-185, CVC6, CVC7P

**GM/Harrison** V5, V5 (DESTROKER), V7

### Control Valve Outer O-Ring

**Mitsubishi** AX105VSR, FXA105VS,  
FXA105VSLR, FXA105VSR,  
FXA105VSSS

### Expansion Valve O-Ring (Lower)

**GM/Harrison** VIR

**M96-2144 Green HNBR**

Alternate: M96-1044 (Black Nitrile)

ID: 0.796" / 20.22mm  
OD: 1.074" / 27.28mm

### Rear Head Sensor Port O-Ring

**Denso** 10PA15C

### Suction / Discharge Port O-Ring

**Calsonic** V5-15C, V5-15F, V5-15G

**Daewoo** V5

**Ford** FS10, FX15, LARGE  
SCROLL

**GM/Harrison** A6, DA6, HR6, HR6HE, R4,  
V5, V5 (DESTROKER)

**Sanden** SD7H15

**Seiko-Seiki** SS170PSS

**M96-2145 Green HNBR**

ID: 0.787" / 19.99mm  
OD: 0.945" / 24.00mm

### Control Valve (4 O-Ring) Outer O-Ring

**Denso** 6SEU16

### Control Valve Outer Center O-Ring

**Denso** 7SEU16

### Control Valve Outer Middle O-Ring

**Denso** 5SE09C, 5SE12C, 7SBU17C,  
7SEU17C

### Control Valve Outer O-Ring

**Denso** 6SEU12, 6SEU12C,  
6SEU14C

**Sanden** PXE13, PXE16, SD7C16

**M96-2146 Green HNBR**

Alternate: M96-1046 (Black Nitrile)

ID: 0.801" / 20.35mm  
OD: 0.941" / 23.90mm

### Bellows Adjustment Screw O-Ring

**Diesel Kiki** DCV14J, DKV14J

### Control Valve Outer O-Ring

**Delphi** CVC-135E

### Suction / Discharge O-Ring

**Sanden** SD7V16

**M96-2147 Green HNBR**

ID: 0.866" / 22.00mm  
OD: 1.056" / 26.82mm

### Control Valve O-Ring

**Sanden** SD6V12

### EPR Valve O-Ring

**Chrysler** RV2

### Lip Seal O-Ring (DL)

**Seiko-Seiki** SS96D1

### Pressure Switch O-Ring

**Denso** 10S20H

**Denso** 10S15C, 10S15L, 10S17C,  
10S20C, 10S20F

### Screen O-Ring

**Sanden** SD7C16

**M96-2148 Green HNBR**

Alternate: M96-1048 (Black Nitrile)

ID: 0.862" / 21.89mm  
OD: 1.068" / 27.13mm

### Shaft Seal Seat O-Ring

**Diesel Kiki** DKS13S, DKS15S, DKS17S

**Sanden** SD708, SD709

## O-Rings and Lathe Cuts

### Switch Port O-Ring

<b>Chrysler</b>	6C17
<b>Daewoo</b>	V5
<b>Ford</b>	SCROLL
<b>GM/Harrison</b>	A6, DA6, HD6, HR6, HR6HE, HT6, HU6, R4, V5, V5 (DESTROKER)

### M96-2149 Green HNBR

ID: 0.945" / 24.00mm  
OD: 1.135" / 28.83mm

### Control Valve (7 O-Ring) O-Ring 7 (Outer / Largest)

**Denso** 6SEU16

### Control Valve Outer O-Ring

**Denso** 7SE16

### Lip Seal O-Ring

**Calsonic** DKV14D  
**Diesel Kiki** DCV11A, DCV14A, DKV11A

### Suction Port O-Ring

**Denso** 7SBU16C

### M96-2150 Green HNBR

ID: 0.457" / 11.61mm  
OD: 0.653" / 16.59mm

### Control Valve Outer O-Ring

**Visteon** VS12M, VS16, VS18M

### M96-2151 Green HNBR

Alternate: M96-1051 (Black Nitrile)

ID: 0.239" / 6.07mm  
OD: 0.367" / 9.32mm

### Control Valve Plunger O-Ring (Top)

**Denso** 10PA15VC, 10PA15VL,  
10PA17VC, 10PA17VL, 10PA17VSC

### Head Bolt O-Ring, Front

**Sanden** TRSA09, TRSA12, TRSE07

### Oil Drain Plug O-Ring

**Sanden** TR090, TR105, TR105VS,  
TR70, TRF090, TRF105, TRS090,  
TRS105

### Rear Housing O-Ring

**Mitsubishi** FX105V, FX80

### M96-2152 Green HNBR

Alternate: M96-1052 (Black Nitrile)

ID: 0.924" / 23.47mm  
OD: 1.130" / 28.70mm

### Service Valve O-Ring

**Chrysler** RV2

### M96-2153 Green HNBR

Alternate: M96-1053 (Black Nitrile)

ID: 0.737" / 18.72mm  
OD: 0.943" / 23.95mm

### Control Valve O-Ring

**Sanden** PXV16, SD7V16

### Lip Seal O-Ring

**Mitsubishi** AX105VSR, FX105V, FX80,  
FXA105VS, FXA105VSLR,  
FXA105VSR, FXA105VSSS,  
MSC105CVS, MSC105VSR, MSC90,  
MSC90C

**Sanden** TR090, TR105, TR105VS,  
TR70, TRF090, TRF105, TRS090,  
TRS105

### Pad Mount Suction O-Ring

**Sanden** SD505, SD507, SD507A2,  
SD508, SD510

### Rear Head Sensor Port O-Ring (for C20-2000) (Lexus)

**Denso** 10PA20C

### Rear Head Sensor Port O-Ring (for C20-2000) (Mercedes)

**Denso** 10PA15C, 10PA15SC,  
10PA17C

### Suc/Disch Port (All) / Rear Sensor Port (10P15C) O-Ring

**Denso** 10P13 Series, 10P15 Series

### Suction / Discharge Port O-Ring

**Ford** FS6, FS6 CROSS MOUNT

### Suction / Discharge Port O-Ring (Factory Hose Assembly)

**Denso** 10P08E, 10P17 Series,  
6E171, 6E171A, 6P Series

### M96-2155 Green HNBR

ID: 0.386" / 9.80mm  
OD: 0.574" / 14.58mm

### Control Valve Middle O-Ring

**Denso** 5SL12CJ, 5SL142, 7SBU16C

**Ford** F500

**Visteon** VS12M, VS16, VS18M

**Zexel** DCS171C

### M96-2156 Green HNBR

ID: 0.417" / 10.59mm  
OD: 0.535" / 13.59mm

### Control Valve Inner O-Ring

**Mitsubishi** AX105VSR, FXA105VS,  
FXA105VSLR, FXA105VSR,  
FXA105VSSS

### Discharge Screen O-Ring

**Sanden** PXE13, PXE16

### M96-2158 Green HNBR

Alternate: M96-1058 (Black Nitrile)

ID: 0.185" / 4.70mm  
OD: 0.297" / 7.54mm

### Liquid Bleed Line O-Ring

**GM/Harrison** VIR

### M96-2164 Green HNBR

Alternate: M96-1064 (Black Nitrile)

ID: 0.634" / 16.10mm  
OD: 0.760" / 19.30mm

### Control Valve Middle O-Ring

**Delphi** CVC-135E

### M96-2171 Green HNBR

ID: 0.350" / 8.89mm  
OD: 0.506" / 12.85mm

### Control Valve Inner O-Ring

**Denso** 5SL12CJ, 5SL142, 7SBU16C

**Ford** F500

**Visteon** VS12M, VS16, VS18M

**Zexel** DCS171C

### M96-2174 Green HNBR

ID: 0.496" / 12.60mm  
OD: 0.636" / 16.15mm

### Control Valve O-Ring

**Diesel Kiki** DCV14J

### L12-2101 HNBR

Alternate: L12-1001 (Nitrile)

Case Seal

### Case Lathe Cut Seal

**Ford** FS6, FS6 CROSS MOUNT

### L25-2101 HNBR

Alternate: L25-1001 (Nitrile)

Case Seal

### Case Lathe Cut Seal

**Sanden** SD505, SD507, SD507A2,  
SD508, SD510, SD5H09, SD5H11,  
SD5H13, SD708, SD709, SD709CP,  
SD7H15

### Case Lathe Cut Seal (Early)

**Sanden** SD7H13

### L11-1003 Nitrile

Oil Pump

### Oil Pump Lathe Cut Seal

**Chrysler** RV2

### L11-1010 Nitrile

Alternate: L11-2110 (HNBR)

Center Case Seal

### Case Lathe Cut Seal (Center Seal on A590)

**Chrysler** A590

### L11-1011 Nitrile

Alternate: L11-2111 (HNBR)

Case Seal

### Case Lathe Cut Seal (F/R on A590, F/C/R on C171)

**Chrysler** A590, C171

### L13-1001 Nitrile

Housing to Receiver Shell (Upper)

### Housing to Receiver Shell Lathe Cut Seal (Upper)

**GM/Harrison** VIR

### L13-1002 Nitrile

Alternate: L13-2102 (HNBR)

Front Nose

### Nose Piece Lathe Cut Seal

**GM/Harrison** R4

## O-Rings and Lathe Cuts

### L20-1010 Nitrile

Case Seal

Base Plate Lathe Cut Seal

**Tecumseh** HG1000, HG850

Case Lathe Cut Seal (6P127D)

**Denso** 6P127D

### L25-1001 Nitrile

Alternate: L25-2101 (HNBR)

Case Seal

Case Lathe Cut Seal

**Sanden** SD505, SD507, SD507A2,  
SD508, SD510, SD5H09, SD5H11,  
SD5H13, SD708, SD709, SD709CP,  
SD7H15

Case Lathe Cut Seal (Early)

**Sanden** SD7H13

### L40-1001 Nitrile

Flange Seal

Flange Lathe Cut Seal

**Tecumseh** HG1000, HG500, HG850

**York** 206, 209, 210

### L40-1002 Nitrile

Alternate: L40-2102 (HNBR)

Tube-O Seal

Rotolock Valve Lathe Cut Seal

**Tecumseh** HG1000, HG850

**York** 206, 209, 210, SC206, SC209

### L40-1012 Nitrile

Plate Seal

Shaft Seal Plate Lathe Cut Seal

**Tecumseh** HG1000, HG500, HG850

**York** SC206, SC209

Shaft Seal Plate Lathe Cut Seal (use w/ 6 Bolt  
Plates)

**York** 206, 209, 210

### L50-1000 Nitrile

Clutch Driver Damper

Clutch Driver Damper Lathe Cut

**Mats/Pan** N1300AC4, N1301AB4,  
N1301AD4, N1301AE4, NL1300AA4,  
NL1300AB4, NL1300AE4, SA1150AE4

### L40-4101 Teflon

Rotolock Seal

Rotolock Service Valve Lathe Cut Seal (White  
Teflon)

**Tecumseh** HG500

Rotolock Valve Lathe Cut Seal (White Teflon)

**Tecumseh** HG1000, HG850

**York** 206, 209, 210, SC206, SC209



## Piston Components

<b>P13-4102</b> Standard Piston w/ Reed  <b>GM/Harrison</b> HD6, HT6, HU6	<b>P60-4000</b> Scroll Set with Pins and Rings  <b>Visteon</b> HS110R	<b>P13-1115</b> 0.6265" - 15.91mm  <b>GM/Harrison</b> A6
<b>P13-4103</b> 11 Cu In w/ Reed - Screw In (Use P13-5102)  <b>GM/Harrison</b> R4	<b>P10-1310</b> 0.5310" / 13.49mm (Standard)  <b>Chrysler</b> A590, C171 <b>Denso</b> 6E171, 6E171A, 6P Series <b>Diesel Kiki</b> DKS13G (DUAL), DKS13G (SINGLE), DKS13S, DKS15BH, DKS15CH, DKS15G, DKS15S, DKS16H(R12), DKS16H(R134A), DKS17CH, DKS17D, DKS17G (DUAL), DKS17G (SINGLE), DKS17S	<b>P13-1120</b> 0.6260" - 15.90mm  <b>GM/Harrison</b> A6
<b>P13-4104</b> Oversize Piston w/ Reed  <b>GM/Harrison</b> HD6, HT6, HU6	<b>Ford</b> FS6, FS6 CROSS MOUNT <b>P10-1315</b> 0.5315" / 13.50mm  <b>Chrysler</b> A590, C171 <b>Denso</b> 6E171, 6E171A, 6P Series <b>Diesel Kiki</b> DKS13G (DUAL), DKS13G (SINGLE), DKS13S, DKS15BH, DKS15CH, DKS15G, DKS15S, DKS16H(R12), DKS16H(R134A), DKS17CH, DKS17D, DKS17G (DUAL), DKS17G (SINGLE), DKS17S	<b>P13-1510</b> 0.5512" - 14.00mm  <b>GM/Harrison</b> A6
<b>P13-4105</b> 11 Cu In w/o Reed - Screw In (Use P13-5102)  <b>GM/Harrison</b> R4	<b>Ford</b> FS6, FS6 CROSS MOUNT <b>P10-1315</b> 0.5315" / 13.50mm  <b>Chrysler</b> A590, C171 <b>Denso</b> 6E171, 6E171A, 6P Series <b>Diesel Kiki</b> DKS13G (DUAL), DKS13G (SINGLE), DKS13S, DKS15BH, DKS15CH, DKS15G, DKS15S, DKS16H(R12), DKS16H(R134A), DKS17CH, DKS17D, DKS17G (DUAL), DKS17G (SINGLE), DKS17S	<b>P13-1520</b> 0.5520" - 14.02mm  <b>GM/Harrison</b> DA6, HD6, HR6, HR6HE, HT6, HU6
<b>P20-4002</b> Piston  <b>Denso</b> 10PA20C, 10PA20H, 10PA20J, 10PA20SC, 10PA20SH, 10PA20VC	<b>Chrysler</b> A590, C171 <b>Denso</b> 6E171, 6E171A, 6P Series <b>Diesel Kiki</b> DKS13G (DUAL), DKS13G (SINGLE), DKS13S, DKS15BH, DKS15CH, DKS15G, DKS15S, DKS16H(R12), DKS16H(R134A), DKS17CH, DKS17D, DKS17G (DUAL), DKS17G (SINGLE), DKS17S	<b>P13-1530</b> 0.5530" - 14.04mm  <b>GM/Harrison</b> DA6, HD6, HR6, HR6HE, HT6, HU6
<b>P20-4016</b> 10S11 Piston  <b>Denso</b> 10S11C	<b>Ford</b> FS6, FS6 CROSS MOUNT <b>P10-1320</b> 0.5320" / 13.51mm  <b>Chrysler</b> A590, C171 <b>Denso</b> 6E171, 6E171A, 6P Series <b>Diesel Kiki</b> DKS13G (DUAL), DKS13G (SINGLE), DKS13S, DKS15BH, DKS15CH, DKS15G, DKS15S, DKS16H(R12), DKS16H(R134A), DKS17CH, DKS17D, DKS17G (DUAL), DKS17G (SINGLE), DKS17S	<b>P25-1010</b> 0.4060" / 10.31mm  <b>Sanden</b> TR090, TR105, TR105VS, TRF090, TRF105, TRS090, TRS105 <b>Visteon</b> HS090L, HS090R, HS110R
<b>P20-4017</b> 10S15 Piston  <b>Denso</b> 10S15C	<b>Ford</b> FS6, FS6 CROSS MOUNT <b>P13-1105</b> 0.625" - 15.87mm  <b>Chrysler</b> A590, C171 <b>Denso</b> 6E171, 6E171A, 6P Series <b>Diesel Kiki</b> DKS13G (DUAL), DKS13G (SINGLE), DKS13S, DKS15BH, DKS15CH, DKS15G, DKS15S, DKS16H(R12), DKS16H(R134A), DKS17CH, DKS17D, DKS17G (DUAL), DKS17G (SINGLE), DKS17S	<b>P25-1020</b> 0.4380" / 11.05mm  <b>Sanden</b> TR090, TR105, TR105VS, TRF090, TRF105, TRS090, TRS105
<b>P20-4018</b> 10S17 Piston  <b>Denso</b> 10S17C	<b>Ford</b> FS6, FS6 CROSS MOUNT <b>P13-1110</b> 0.6255" - 15.89mm  <b>GM/Harrison</b> A6	<b>P25-1875</b> 0.8750" / 22.23mm  <b>Sanden</b> SD505, SD507, SD507A2, SD508, SD510, SD5H09, SD5H11, SD5H13, SD708, SD709, SD709CA, SD709CP, SD7B10, SD7H15
<b>P20-4019</b> 10S20 Piston  <b>Denso</b> 10S20C	<b>GM/Harrison</b> A6 <b>P13-1110</b> 0.6255" - 15.89mm  <b>GM/Harrison</b> A6	<b>P55-1101</b> 0.5990" - 12.67mm  <b>Mitsubishi</b> AX105VSR, FX105V, FXA105VS, FXA105VSLR, FXA105VSR, FXA105VSSS
<b>P25-4000</b> Matching Set of Two Scroll Rings  <b>Sanden</b> TR090, TRF090, TRS090	<b>GM/Harrison</b> A6	<b>P55-1101</b> 0.5990" - 12.67mm  <b>Mitsubishi</b> AX105VSR, FX105V, FXA105VS, FXA105VSLR, FXA105VSR, FXA105VSSS

## Piston Components

### P65-1594 Piston Ball

0.594"-15.08mm



**Hitachi** A5000, MJ110, MJ123, MJ167, MJS130, MJS170, SWP123, SWP167

### P65-1595 Piston Ball

0.595"-15.11mm



**Hitachi** A5000, MJ110, MJ123, MJ167, MJS130, MJS170, SWP123, SWP167

### P13-2247 Piston Ball Shoe

0.0200"



**GM/Harrison** DA6, HR6, HR6HE

### P12-2020 Piston Half Ball

7.490mm - 7.495mm



**Ford** FS10, FX15  
**Visteon** HS15, HS17, HS18

### P12-2021 Piston Half Ball

7.495mm - 7.500mm



**Ford** FS10, FX15  
**Visteon** HS15, HS17, HS18

### P12-2022 Piston Half Ball

7.500mm - 7.505mm



**Ford** FS10, FX15  
**Visteon** HS15, HS17, HS18

### P12-2023 Piston Half Ball

7.505mm - 7.510mm



**Ford** FS10, FX15  
**Visteon** HS15, HS17, HS18

### P12-2024 Piston Half Ball

7.510mm - 7.515mm



**Ford** FS10, FX15  
**Visteon** HS15, HS17, HS18

### P12-2025 Piston Half Ball

7.515mm - 7.520mm



**Ford** FS10, FX15  
**Visteon** HS15, HS17, HS18

### P12-2026 Piston Half Ball

7.520mm - 7.525mm



**Ford** FS10, FX15  
**Visteon** HS15, HS17, HS18

### P12-2027 Piston Half Ball

7.525mm - 7.530mm



**Ford** FS10, FX15  
**Visteon** HS15, HS17, HS18

### P12-2028 Piston Half Ball

7.530mm - 7.535mm



**Ford** FS10, FX15  
**Visteon** HS15, HS17, HS18

### P12-2029 Piston Half Ball

7.535mm - 7.540mm



**Ford** FS10, FX15  
**Visteon** HS15, HS17, HS18

### P20-1001 Piston Half Ball

Ball Shoe 7.890 - 7.895mm



**Denso** 10PA15 Series, 10PA17 Series, 10PA20C, 10PA20H, 10PA20J, 10PA20SC, 10PA20SH, 10PA20VC, 10S15C, 10S15L, 10S17C, 10S20C, 10S20F, 10S20H

### P20-1002 Piston Half Ball

Ball Shoe 7.895 - 7.900mm



**Denso** 10PA15 Series, 10PA17 Series, 10PA20C, 10PA20H, 10PA20J, 10PA20SC, 10PA20SH, 10PA20VC, 10S15C, 10S15L, 10S17C, 10S20C, 10S20F, 10S20H

### P20-1003 Piston Half Ball

Ball Shoe 7.900 - 7.905mm



**Denso** 10PA15 Series, 10PA17 Series, 10PA20C, 10PA20H, 10PA20J, 10PA20SC, 10PA20SH, 10PA20VC, 10S15C, 10S15L, 10S17C, 10S20C, 10S20F, 10S20H

### P20-1004 Piston Half Ball

Ball Shoe 7.905 - 7.910mm



**Denso** 10PA15 Series, 10PA17 Series, 10PA20C, 10PA20H, 10PA20J, 10PA20SC, 10PA20SH, 10PA20VC, 10S15C, 10S15L, 10S17C, 10S20C, 10S20F, 10S20H

### P20-1005 Piston Half Ball

Ball Shoe 7.910 - 7.915mm



**Denso** 10PA15 Series, 10PA17 Series, 10PA20C, 10PA20H, 10PA20J, 10PA20SC, 10PA20SH, 10PA20VC, 10S15C, 10S15L, 10S17C, 10S20C, 10S20F, 10S20H

### P20-1006 Piston Half Ball

Ball Shoe 7.915 - 7.920mm



**Denso** 10PA15 Series, 10PA17 Series, 10PA20C, 10PA20H, 10PA20J, 10PA20SC, 10PA20SH, 10PA20VC, 10S15C, 10S15L, 10S17C, 10S20C, 10S20F, 10S20H

### P20-1007 Piston Half Ball

Ball Shoe 7.920 - 7.925mm



**Denso** 10PA15 Series, 10PA17 Series, 10PA20C, 10PA20H, 10PA20J, 10PA20SC, 10PA20SH, 10PA20VC, 10S15C, 10S15L, 10S17C, 10S20C, 10S20F, 10S20H

### P20-1008 Piston Half Ball

Ball Shoe 7.925 - 7.930mm



**Denso** 10PA15 Series, 10PA17 Series, 10PA20C, 10PA20H, 10PA20J, 10PA20SC, 10PA20SH, 10PA20VC, 10S15C, 10S15L, 10S17C, 10S20C, 10S20F, 10S20H











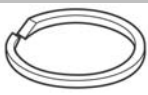



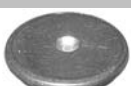

### P20-1009 Piston Half Ball

Ball Shoe 7.930 - 7.935mm

































**Denso** 10PA15 Series, 10PA17 Series, 10PA20C, 10PA20H, 10PA20J, 10PA20SC, 10PA20SH, 10PA20VC, 10S15C, 10S15L, 10S17C, 10S20C, 10S20F

## Piston Components

<b>P20-1010</b> Ball Shoe 7.935 - 7.940mm 	<b>Piston Half Ball</b> <b>Denso</b> 10PA15 Series, 10PA17 Series, 10PA20C, 10PA20H, 10PA20J, 10PA20SC, 10PA20SH, 10PA20VC, 10S15C, 10S15L, 10S17C, 10S20C, 10S20F, 10S20H	<b>P11-3110</b> 0.075" - 1.91mm 	<b>Piston Ring</b> <b>Sanden</b> SD708, SD709, SD709CA, SD709CP, SD7H15
<b>P20-1012</b> Ball Shoe 	<b>Piston Half Ball</b> <b>Denso</b> 7SBU16C, 7SEU16	<b>P12-3100</b> 0.032" - 0.813mm Teflon 	<b>Piston Ring</b> <b>Sanden</b> SD7C16, SD7V16
<b>P20-1013</b> Ball Shoe 	<b>Piston Half Ball</b> <b>Denso</b> 7SBU16C, 7SEU16	<b>P12-3101</b> 0.044" - 1.12mm Teflon 	<b>Piston Ring</b> <b>Sanden</b> SD7V16
<b>P20-1014</b> Ball Shoe 	<b>Piston Half Ball</b> <b>Denso</b> 7SBU16C, 7SEU16	<b>P13-3125</b> 0.025" - 0.64mm Teflon 	<b>Piston Ring</b> <b>Sanden</b> TRF090, TRSA09, TRSE07
<b>P20-1015</b> Ball Shoe 	<b>Piston Half Ball</b> <b>Denso</b> 7SBU16C, 7SEU16	<b>P13-3237</b> 0.037" - 0.940mm Teflon 	<b>Piston Ring</b> <b>Mats/Pan</b> N1300AC4, N1301AB4, N1301AD4, N1301AE4, NL1300AA4, NL1300AB4, NL1300AE4, S1150F3, S1150X3, SA1150AE4
<b>P20-1018</b> Ball Shoe 	<b>Piston Half Ball</b> <b>Denso</b> 7SBU16C, 7SEU16	<b>P13-3280</b> 0.080" - 2.032mm Teflon 	<b>Piston Ring</b> <b>Visteon</b> HS090L, HS090R
<b>P20-2007</b> No.8 	<b>Piston Half Ball</b> <b>Denso</b> 10P08E, 10P13 Series, 10P15 Series, 10P17C, 10P17VC	<b>P13-3305</b> 0.125" - 3.18mm Teflon 	<b>Piston Ring</b> <b>Visteon</b> HS110R
<b>P20-2008</b> No.9 	<b>Piston Half Ball</b> <b>Denso</b> 10P08E, 10P13 Series, 10P15 Series, 10P17C, 10P17VC	<b>P13-3330</b> 0.030" - 0.76mm Teflon 	<b>Piston Ring</b> <b>Keihin</b> 150L, 150R
<b>P20-2009</b> No.10 	<b>Piston Half Ball</b> <b>Denso</b> 10P08E, 10P13 Series, 10P15 Series, 10P17C, 10P17VC	<b>P13-3530</b> 0.030" - 0.76mm Teflon 	<b>Piston Ring</b> <b>GM/Harrison R4</b>
		<b>P25-3000</b> Piston Ring - Standard	<b>Piston Ring</b> <b>GM/Harrison R4</b>

## Reeds and Valve Plates

<b>R11-2101</b> Thick <b>Chrysler</b> RV2	Discharge Reed 	<b>R20-2001</b> <b>Denso</b> 10PA20C, 10PA20H, 10PA20J, 10PA20SC, 10PA20SH, 10PA20VC	Discharge Reed 	<b>R40-2102</b> <b>York</b> 206, 209, 210, SC206, SC209	Discharge Reed 
<b>R11-2110</b> <b>Chrysler</b> A590, C171	Discharge Reed 	<b>R20-2002</b> <b>Denso</b> 7SB16C	Discharge Reed 	<b>R11-1101</b> Thin <b>Chrysler</b> RV2	Suction Reed 
<b>R12-2000</b> <b>Ford</b> FS10, FS18	Discharge Reed 	<b>R20-2003</b> <b>Denso</b> 7SBU16C, 7SBU17C, 7SEU16, 7SEU17C	Discharge Reed 	<b>R11-1110</b> <b>Chrysler</b> A590, C171 <b>Ford</b> FS6, FS6 CROSS MOUNT	Suction Reed 
<b>R12-2110</b> <b>Ford</b> FS6, FS6 CROSS MOUNT	Discharge Reed 	<b>R20-2004</b> <b>Denso</b> 10S15C, 10S15L, 10S17C, 10S20C, 10S20F, 10S20H	Discharge Reed 	<b>R12-1000</b> <b>Ford</b> FS10	Suction Reed 
<b>R13-2101</b> <b>GM/Harrison A6</b>	Discharge Reed 	<b>R25-2000</b> Reed - Discharge Valve	Discharge Reed 	<b>R13-1003</b> <b>GM/Harrison HD6, HT6, HU6</b>	Suction Reed 
<b>R13-2102</b> <b>GM/Harrison HD6, HT6, HU6</b>	Discharge Reed 	<b>R25-2110</b> <b>Sanden</b> SD7V16	Discharge Reed 	<b>R13-1004</b> Suction Reed	Suction Reed 
<b>R13-2142</b> Single Prong <b>GM/Harrison DA6, HR6, HR6HE</b>	Discharge Reed 	<b>R25-2115</b> <b>Sanden</b> SD505, SD507, SD507A2, SD508, SD510, SD5H09, SD5H11, SD5H13	Discharge Reed 	<b>R20-1000</b> <b>Denso</b> 10PA15 Series, 10PA17 Series	Suction Reed 
<b>R13-2143</b> Double Prong <b>GM/Harrison DA6, HR6, HR6HE</b>	Discharge Reed 	<b>R25-2120</b> New Style <b>Sanden</b> SD708, SD709, SD709CA, SD709CP, SD7H15	Discharge Reed 	<b>R20-1002</b> <b>Denso</b> 7SB16C	Suction Reed 
<b>R13-2144</b> w/ Indicator <b>GM/Harrison R4</b>	Discharge Reed 	<b>R40-2101</b> <b>Tecumseh</b> HG1000, HG500, HG850	Discharge Reed 	<b>R20-1003</b> <b>Denso</b> 7SBU16C	Suction Reed 
<b>R20-2000</b> <b>Denso</b> 10PA15 Series, 10PA17 Series	Discharge Reed 		Discharge Reed 	<b>R20-1004</b> <b>Denso</b> 10S15C, 10S15L, 10S17C, 10S20C, 10S20F, 10S20H	Suction Reed 

## Reeds and Valve Plates

**R25-1110**

**Suction Reed**



**Sanden** SD505, SD507, SD507A2,  
SD508, SD510, SD5H09, SD5H11,  
SD5H13, SD7V16

**R25-1115**

**Suction Reed**



**Sanden** SD708, SD709, SD709CA,  
SD709CP, SD7H15

**R40-1101**

**Suction Reed**



**Tecumseh** HG1000, HG500, HG850

**R40-1102**

**Suction Reed**



**York** 206, 209, 210, SC206, SC209

**H20-6000**

**Valve Plates**

Valve Plate (Front)



**Denso** 10PA15 Series, 10PA17A,  
10PA17C, 10PA17E, 10PA17H, 10PA17J,  
10PA17K, 10PA17VC, 10PA17VL

**H20-6001**

**Valve Plates**

Valve Plate (Rear)



**Denso** 10PA15A, 10PA15C,  
10PA15E, 10PA15L, 10PA15LC,  
10PA15SC, 10PA15VL, 10PA17A,  
10PA17C, 10PA17E, 10PA17H, 10PA17J,  
10PA17K, 10PA17VL

**H20-6003**

**Valve Plates**

Valve Plate (Rear)



**Denso** 10PA20C, 10PA20H, 10PA20J

**H20-6004**

**Valve Plates**

Valve Plate



**Denso** 7SB16C

**H20-6006**

**Valve Plates**

Valve Plate (Front)



**Denso** 10S15C, 10S15L, 10S17C,  
10S20C, 10S20F, 10S20H

**H20-6007**

**Valve Plates**

Valve Plate (Rear)



**Denso** 10S15C, 10S15L, 10S17C,  
10S20C, 10S20F, 10S20H

**H20-6010**

**Valve Plates**

Valve Plate



**Denso** 7SBU16C, 7SBU17C,  
7SEU16, 7SEU17C

**H25-6000**

**Valve Plates**

Valve Plate



**Sanden** SD7V16

## Service Items

### A10-5103

#### Adapters

Flare to Tube Adapter - #8



**Sanden** SD505, SD507, SD507A2, SD508, SD510, SD5H09, SD5H11, SD5H13

### A10-5104

#### Adapters

Flare to Tube Adapter - #10



**Sanden** SD505, SD507, SD507A2, SD508, SD510, SD5H09, SD5H11, SD5H13

### A10-5122

#### Pressure Relief Valve

Pressure Relief Valve



**Denso** 7SE16  
**Diesel Kiki** DCV14J, DKS17D, DKV11G, DKV14G, DKV14J  
**Ford** F500, FS18  
**Hadsys** RC17D, RC17S  
**Mitsubishi** MSC130CVSG, MSC130CVSG2  
**Sanden** PXE13, PXE16, PXV16, TRSA09, TRSA12, TRSE07  
**Seiko-Seiki** SS10LV6, SS10V1, SS10V6  
**Visteon** HS090L, HS090R, HS110R, HS15, HS17, HS18, VS16, VS18M  
**Zexel** DCS17E

### A10-5123

#### Pressure Relief Valve

Pressure Relief Valve



**Calsonic** CSV613  
**Delphi** CVC-125, CVC-135, CVC-135E, CVC-165, CVC-185, CVC6, CVC7P, SPI5

### A10-5127

#### Pressure Relief Valve

Pressure Relief Valve



### A10-5128

#### Pressure Relief Valve

Pressure Relief Valve



### A13-5125

#### Pressure Relief Valve

Pressure Relief Valve



**Calsonic** V5-15C, V5-15F, V5-15G  
**Daewoo** V5

**GM/Harrison** DA6, HD6, HR6, HR6HE, HT6, HU6, R4, V5, V5 (DESTROKER), V7

### A13-5161

#### Pressure Relief Valve

Pressure Relief Valve



**GM/Harrison** A6

### A20-5203

#### Pressure Relief Valve

Pressure Relief Valve



**Denso** 10PA15A, 10PA15C, 10PA15E, 10PA15L, 10PA15LC, 10PA15SC, 10PA15VC, 10PA17A, 10PA17C, 10PA17E, 10PA17H, 10PA17J, 10PA17K, 10PA17VC, 10PA20, 10PA20C, 10PA20H, 10PA20J, 10S11C, 10S11P, 10S13C, 10S13P, 10S15C, 10S15L, 10S17C, 10S20C, 10S20F

**Mats/Pan** H12A1AH4DX

### A11-1000

#### Sealing Washer

Sealing Washer - Chrysler  
 Discharge Hook Washer



Rubber ID: 11.43mm  
 Steel OD: 29.59mm  
 Steel Length: 43.65mm  
 Rubber Thick: 2.64mm  
 Steel Thick: 1.65mm

### A11-1001

#### Sealing Washer

Sealing Washer - Chrysler  
 Suction Hook Washer



Rubber ID: 15.88mm  
 Steel OD: 29.59mm  
 Steel Length: 43.65mm  
 Rubber Thick: 2.64mm  
 Steel Thick: 1.65mm

### A11-1008

#### Sealing Washer

Sealing Washer - Slim Line



Rubber ID: 7.92mm  
 Steel OD: 15.90mm  
 Rubber Thick: 1.98mm  
 Steel Thick: 1.22mm

### A11-1009

#### Sealing Washer

Sealing Washer - Slim Line



Rubber ID: 9.52mm  
 Steel OD: 17.35mm  
 Rubber Thick: 1.98mm  
 Steel Thick: 1.22mm

### A11-1010

#### Sealing Washer

Sealing Washer - Slim Line



Rubber ID: 14.91mm  
 Steel OD: 23.01mm  
 Rubber Thick: 1.91mm  
 Steel Thick: 1.22mm

### A11-1011

#### Sealing Washer

Sealing Washer - Slim Line



Rubber ID: 17.15mm  
 Steel OD: 25.07mm  
 Rubber Thick: 2.01mm  
 Steel Thick: 1.22mm

### A11-1012

#### Sealing Washer

Sealing Washer - Slim Line



Rubber ID: 17.53mm  
 Steel OD: 25.65mm  
 Rubber Thick: 2.01mm  
 Steel Thick: 1.27mm

### A11-1013

#### Sealing Washer

Sealing Washer - Slim Line



Rubber ID: 17.91mm  
 Steel OD: 27.99mm  
 Rubber Thick: 1.91mm  
 Steel Thick: 1.22mm

### A11-1015

#### Sealing Washer

Sealing Washer - Slim Line



Rubber ID: 11.18mm  
 Steel OD: 19.02mm  
 Rubber Thick: 2.03mm  
 Steel Thick: 1.27mm

### A11-1016

















#### Sealing Washer

Sealing Washer - Slim Line



Rubber ID: 14.99mm  
 Steel OD: 23.80mm  
 Rubber Thick: 1.91mm  
 Steel Thick: 1.22mm

## Service Items

<p><b>A11-1017</b> Sealing Washer</p> <p>Sealing Washer - Slim Line</p>  <p>Rubber ID: 17.15mm Steel OD: 25.30mm Rubber Thick: 2.01mm Steel Thick: 1.22mm</p>	<p><b>A13-1123</b> Sealing Washer</p> <p>Sealing Washers-3/4" Silver (Thin)</p>  <p>Rubber ID: 17.27mm Steel OD: 31.57mm Rubber Thick: 2.03mm Steel Thick: 1.24mm</p> <p><b>GM/Harrison</b> DA6, HD6, HR6, HR6HE, HT6, HU6, R4, V5, V5 (DESTROKER), V7</p>	<p><b>A13-1137</b> Sealing Washer</p> <p>15mm-Slim-Line Sealing Washer (#10)</p>  <p>Rubber ID: 15.49mm Steel OD: 23.65mm Rubber Thick: 1.91mm Steel Thick: 1.27mm</p> <p><b>GM/Harrison</b> DA6, HD6, HR6, HR6HE, HT6, HU6, R4, V5, V5 (DESTROKER), V7</p>
<p><b>A11-1018</b> Sealing Washer</p> <p>Sealing Washer - Slim Line</p>  <p>Rubber ID: 19.56mm Steel OD: 29.72mm Rubber Thick: 1.91mm Steel Thick: 1.22mm</p>	<p><b>A13-1124</b> Sealing Washer</p> <p>Sealing Washers-5/8" Silver (Thin)</p>  <p>Rubber ID: 15.24mm Steel OD: 27.99mm Rubber Thick: 2.03mm Steel Thick: 1.24mm</p> <p><b>GM/Harrison</b> DA6, HD6, HR6, HR6HE, HT6, HU6, R4, V5, V5 (DESTROKER), V7</p>	<p><b>A13-1139</b> Sealing Washer</p> <p>8mm-Slim-Line Sealing Washer (#6)</p>  <p>Rubber ID: 8.26mm Steel OD: 16.05mm Rubber Thick: 20.32mm Steel Thick: 1.27mm</p>
<p><b>A11-1019</b> Sealing Washer</p> <p>Sealing Washer - Slim Line</p>  <p>Rubber ID: 13.31mm Steel OD: 23.70mm Rubber Thick: 1.91mm Steel Thick: 1.22mm</p>	<p><b>A13-1126</b> Sealing Washer</p> <p>Sealing Washers-5/8" Green (Thick)</p>  <p>Rubber ID: 15.49mm Steel OD: 29.59mm Rubber Thick: 7.32mm Steel Thick: 5.44mm</p> <p><b>GM/Harrison</b> DA6, HD6, HR6, HR6HE, HT6, HU6, R4, V5, V5 (DESTROKER), V7</p>	<p><b>A13-1140</b> Sealing Washer</p> <p>11mm-Slim-Line Sealing Washer (#8)</p>  <p>Rubber ID: 11.18mm Steel OD: 19.10mm Rubber Thick: 2.03mm Steel Thick: 1.27mm</p> <p><b>Mitsubishi</b> MSC130CVSG, MSC130CVSG2</p>
<p><b>A11-1020</b> Sealing Washer</p> <p>Sealing Washer - Slim Line</p>  <p>Rubber ID: 17.07mm Steel OD: 25.35mm Rubber Thick: 2.19mm Steel Thick: 1.22mm</p>	<p><b>A13-1127</b> Sealing Washer</p> <p>Sealing Washers-5/8" Red (Thick)</p>  <p>Rubber ID: 15.49mm Steel OD: 29.59mm Rubber Thick: 5.00mm Steel Thick: 3.68mm</p> <p><b>GM/Harrison</b> DA6, HD6, HR6, HR6HE, HT6, HU6, R4, V5, V5 (DESTROKER), V7</p>	<p><b>A13-1141</b> Sealing Washer</p> <p>17mm-Slim-Line Sealing Washer (#12)</p>  <p>Rubber ID: 17.32mm Steel OD: 25.40mm Rubber Thick: 2.08mm Steel Thick: 1.22mm</p> <p><b>Mitsubishi</b> MSC130CVSG, MSC130CVSG2</p>
<p><b>A11-1021</b> Sealing Washer</p> <p>Sealing Washer - Slim Line</p>  <p>Rubber ID: 15.50mm Steel OD: 23.65mm Rubber Thick: 2.11mm Steel Thick: 1.22mm</p>	<p><b>A13-1128</b> Sealing Washer</p> <p>Sealing Washers-5/8" Yellow (Thick)</p>  <p>Rubber ID: 15.49mm Steel OD: 33.22mm Rubber Thick: 3.96mm Steel Thick: 3.05mm</p> <p><b>GM/Harrison</b> DA6, HD6, HR6, HR6HE, HT6, HU6, R4, V5, V5 (DESTROKER), V7</p>	<p><b>A96-1006</b> Sealing Washer</p> <p>Stat-O-Seal - 8.15mm I.D.</p>  <p>Rubber ID: 8.26mm Steel OD: 15.95mm Rubber Thick: 1.91mm Steel Thick: 1.22mm</p>
<p><b>A13-1122</b> Sealing Washer</p> <p>Sealing Washers-5/8" Black (Thick)</p>  <p>Rubber ID: 15.24mm Steel OD: 29.51mm Rubber Thick: 4.11mm Steel Thick: 3.10mm</p> <p><b>GM/Harrison</b> DA6, HD6, HR6, HR6HE, HT6, HU6, R4, V5, V5 (DESTROKER), V7</p>	<p><b>A96-1007</b> Sealing Washer</p> <p>Stat-O-Seal - 11.23mm I.D.</p>  <p>Rubber ID: 11.23mm Steel OD: 19.05mm Rubber Thick: 1.91mm Steel Thick: 1.22mm</p>	

## Service Items

### A96-1008

#### Sealing Washer

Stat-O-Seal - 14.22mm I.D.



Rubber ID: 14.22mm  
Steel OD: 23.60mm  
Rubber Thick: 1.91mm  
Steel Thick: 1.22mm

### A96-1009

#### Sealing Washer

Stat-O-Seal - 17.27mm I.D.



Rubber ID: 17.27mm  
Steel OD: 25.25mm  
Rubber Thick: 1.91mm  
Steel Thick: 1.22mm

### A96-1010

#### Sealing Washer

Stat-O-Seal - 15.37mm I.D.



Rubber ID: 15.24mm  
Steel OD: 28.02mm  
Rubber Thick: 1.91mm  
Steel Thick: 1.22mm

### A96-1011

#### Sealing Washer

Sealing Washer - Slim Line - 8.16mm I.D.



Rubber ID: 8.16mm  
Steel OD: 14.28mm  
Rubber Thick: 1.91mm  
Steel Thick: 1.22mm

### A96-1012

#### Sealing Washer

Sealing Washer - Slim Line - 11.34mm I.D.



Rubber ID: 11.34mm  
Steel OD: 17.29mm  
Rubber Thick: 1.91mm  
Steel Thick: 1.22mm

### A96-1013

#### Sealing Washer

Sealing Washer - Slim Line - 13.86mm I.D.



Rubber ID: 13.86mm  
Steel OD: 19.97mm  
Rubber Thick: 1.91mm  
Steel Thick: 1.22mm

### A13-1138

#### Sealing Washer Adapte

Adapter Block



GM/Harrison DA6, HD6, HR6, HR6HE, HT6, HU6, R4, V5, V5 (DESTROKER), V7

### A13-5109

#### Sealing Washer Pilot

Long Manifold Pilot Washer Insert



GM/Harrison DA6, HD6, HR6, HR6HE, HU6, R4, V5, V5 (DESTROKER), V7

### A13-5110

#### Sealing Washer Pilot

Short Manifold Pilot Washer Insert



GM/Harrison DA6, HD6, HR6, HR6HE, HU6, R4, V5, V5 (DESTROKER), V7

### A10-1024

#### Valve Components

1/8" NPT Brass Port W/ Valve



Chrysler C171

Denso 10P08E, 10P13 Series, 10P15 Series, 10P17 Series, 10PA15 Series, 10PA17 Series, 10PA20C, 10PA20H, 10PA20J, 10PA20SC, 10PA20SH, 10PA20VC, 10S15C, 10S17C, 10S20C, 10S20F, 10S20H, 6E171, 6E171A, 6P Series

Ford FS6, FS6 CROSS MOUNT

### A10-1025

#### Valve Components

1/8-28 UNF Fitting with Valve/O-Ring



Chrysler A590, C171

Diesel Kiki DCW17B, DCW17D

Sanden SD505, SD507, SD507A2, SD508, SD510, SD708, SD709, SD709CA

Seiko-Seiki SS170PSS

### A10-1120

#### Valve Components

Standard Pressure Valve Core



Denso 10P08E

GM/Harrison VIR

Mitsubishi FX105V, FX80

### A10-1121

#### Valve Components

Low Pressure Valve Core



GM/Harrison VIR

### A13-1118

#### Valve Components

Primary Seal Fitting w/ Valve Core



### A13-1134

#### Valve Components

GM Low Side Steel High Flow Fitting



### A13-1143

#### Valve Components

GM High Side Steel High Flow Fitting (Europe)



### A13-1144

#### Valve Components

GM Low Side Steel High Flow Fitting (Europe)

### A13-2101

#### VIR Parts

Accumulator Desiccant Bag (R134a Compatible)



GM/Harrison VIR

### A13-5101

#### VIR Parts

Sightglass



GM/Harrison VIR

### A13-5102

#### VIR Parts

Sightglass Gasket



GM/Harrison VIR

### A13-5105

#### VIR Parts

Pick-up Tube Screen



GM/Harrison VIR

### K13-1114

#### Sealing Washer Kit

GM Sealing Washer Kit



Includes: 5/8" Thick Sealing Washer (Green) (1), 5/8" Thick Sealing Washer (Red) (1), 5/8" Thick Sealing Washer (Yellow) (1), Manifold Pilot Washer (Long) (1), Manifold Pilot Washer Insert ('88-'91) (1)



## Service Items

### K13-2101 Sealing Washer Kit

2 ea. - 5/8" (Thick) and Inserts



Includes: 5/8" Thick GM Sealing Washer (Black) (2), Manifold Pilot Washer Insert (2).

GM/Harrison R4

### K13-2102 Sealing Washer Kit

1 ea. - 5/8" (Thin) & 1 ea. - 3/4" (Thin)



Includes: 5/8" (Thin) Sealing Washer (1), 3/4" Sealing Washer (1)

GM/Harrison R4

### K13-2125 Sealing Washer Kit

Adapter Kit



Includes: 5/8" Thick (Black) (2), 3/4" Thin (Silver) (1), 5/8" Thin (Silver) (2), 5/8" Thick (Green) (1), 5/8" Thick (Red) (1), 5/8" Thick (Yellow) (1), Pilot (Long) (1), Pilot (Short) (1)

GM/Harrison V5, V5 (DESTROKER)

### K13-2126 Sealing Washer Kit

Adapter Kit



Includes: 5/8" Thick (Black) (2), 5/8" Thin (Silver) (2), 5/8" Thick (Green) (1), 5/8" Thick (Red) (1), 5/8" Thick (Yellow) (1), #10 Slim-Line (2), Pilot (Long) (1), Pilot (Short) (1)

GM/Harrison HD6, HR6, HR6HE, HT6

### K13-2127 Sealing Washer Kit

Adapter Kit



Includes: 3/4" Thin (Silver) (2), 5/8" Thin (Silver) (2), 5/8" Thick (Green) (1), 5/8" Thick (Red) (1), 5/8" Thick (Yellow) (1), Pilot (Long) (1), Pilot (Short) (1)

GM/Harrison R4

### K13-2135 Sealing Washer Kit

1 Kit - GM Sealing Washer - Silver 5/8" Thin / Chrysler



Includes: 5/8" Silver Sealing Washers (2)

GM/Harrison DA6, HD6, HR6, HR6HE, HT6, HU6, R4, V5, V5 (DESTROKER), V7

### K13-5104 Sealing Washer Kit

Compressor to Hose Manifold



Includes: 5/8" Thick Sealing Washer (Black) (1), 3/4" Thin Sealing Washer (Silver) (1), 5/8" Thin Sealing Washer (Silver) (1), 5/8" Thick Sealing Washer (Red) (1), 5/8" Thick Sealing Washer (Yellow) (1), Adapter Block (1), Block Bolt (1)

GM/Harrison DA6, HD6, HR6, HR6HE, HT6, HU6, R4, V5, V5 (DESTROKER)

### K10-1318 Teardrop Kit

Navistar Discharge Sealing Washer and O-Ring Kit



Includes: Discharge Sealing Washer (1), Discharge O-Ring (1).

### K10-1319 Teardrop Kit

Navistar Suction Sealing Washer and O-Ring Kit



Includes: Suction Sealing Washer (1), Suction O-Ring (1).

### K10-1322 Teardrop Kit

Navistar Suction / Discharge Sealing Washer and O-Ring Kit



Includes: Discharge Sealing Washer (1), Discharge O-Ring (1), Suction Sealing Washer (1), Suction O-Ring (1).

### K11-2108 Teardrop Kit

Chrysler Discharge Sealing Washer and O-Ring Kit



Includes: Discharge Sealing Washer (1), Discharge O-Ring (1).

Denso 10S17C

### K11-2109 Teardrop Kit

Chrysler Suction Sealing Washer and O-Ring Kit



Includes: Suction Sealing Washer (1), Suction O-Ring (1).

Denso 10S17C

### K12-1124 Teardrop Kit

Ford Discharge Sealing Washer and O-Ring Kit



Includes: Discharge Sealing Washer (1), Discharge O-Ring (1).

## Service Items

**K12-1125**

**Teardrop Kit**

Ford Suction Sealing Washer and O-Ring Kit



Includes: Suction Sealing Washer (1),  
Suction O-Ring (1).

## Shaft Seals

### S11-2101 Carbon Seal-HNBR



**Chrysler** A590, C171  
**Denso** 10P08E, 10P13 Series, 10P15 Series, 10P17 Series, 10PA15A, 10PA15C, 10PA15E, 10PA15L, 10PA15LC, 10PA15SC, 10PA17A, 10PA17C, 10PA17E, 10PA17H, 10PA17J, 10PA17K, 10PA17SC, 10PA17SH, 6E171, 6E171A, 6P Series  
**Ford** FS6, FS6 CROSS MOUNT

### S13-2101 Carbon Seal-HNBR



**GM/Harrison** A6, R4  
**Sanden** SD507, SD507A2, SD508, SD510  
**Seiko-Seiki** SS170PSS

### S25-2102 Carbon Seal-HNBR



**Mats/Pan** N1300AC4, N1301AB4, N1301AD4, N1301AE4, NL1300AA4, NL1300AB4, NL1300AE4, S1150F3, S1150X3, SA1150AE4  
**Mitsubishi** FX105V  
**Sanden** SD505, SD5H09, TR090, TR105, TR105VS, TR70, TRF090, TRF105, TRS090, TRS105

### S45-2101 Carbon Seal-HNBR



**Behr** WINGCELL  
**Nihon** DKV14B

### S45-2102 Carbon Seal-HNBR



**Calsonic** DKV14D  
**Diesel Kiki** DCV11A, DCV11D, DCV14A, DKV11A, DKV11D  
**Nihon** DKV14B, DKV14C, NVR140S

### S60-2101 Carbon Seal-HNBR



**Keihin** 150L, 150R

### S11-2000 Carbon Seal-Nitrile



**Chrysler** RV2

### S20-2003 Carbon Seal-Nitrile

Carbon Ring Only



**Denso** TV12C(R12), TV12EC(R12), TV14C, TV14EC

### S20-2004 Carbon Seal-Nitrile

Carbon Ring Only



**Denso** TV12C(R12), TV12EC(R12), TV14C, TV14EC

### S20-2005 Carbon Seal-Nitrile

Complete Carbon Shaft Seal Assembly



**Denso** TV10 Series

### S25-2003 Carbon Seal-Nitrile



**Diesel Kiki** DKS13G (DUAL), DKS13G (SINGLE), DKS13S, DKS15BH, DKS15G, DKS15S, DKS17G (DUAL), DKS17G (SINGLE), DKS17S  
**Sanden** SD708, SD709

### S40-2001 Carbon Seal-Nitrile



**Tecumseh** HG500  
**York** 206, 209, 210, SC206, SC209

### S40-2002 Carbon Seal-Nitrile

6 Bolt - 7/32" Holes



**Tecumseh** HG1000, HG500, HG850  
**York** 206, 209, 210

### S40-5101 Dust Shield

For 6 Bolt - 7/32" Hole and 5 Bolt Hole



**Tecumseh** HG500  
**York** 206, 209, 210, SC206, SC209

### S40-5103 Dust Shield

For 6 Bolt - 9/32" Hole



**Tecumseh** HG1000, HG500, HG850  
**York** 206, 209, 210, SC206, SC209

### S11-6101 Felt Wiper



**Chrysler** A590, C171  
**Delphi** CVC-165, CVC-185, CVC7P  
**Denso** 10P08E, 10P17 Series, 6E171, 6E171A, 6P Series  
**Ford** FS6, FS6 CROSS MOUNT

### S13-4101 Felt Wiper



**Chrysler** A590, C171  
**Denso** 6P Series  
**Ford** F500, FS10, FS18, FS6, FS6 CROSS MOUNT, FX15  
**GM/Harrison** A6, R4  
**Visteon** HS15, HS17, HS18

### S20-6101 Felt Wiper



**Chrysler** 6C17  
**Denso** 10P13 Series, 10P15 Series, 5SE09C, 5SE12C, 6SEU12, 6SEU12C, 6SEU14C, 6SEU16, 7SE16, 7SEU16, 7SEU17C  
**Seiko-Seiki** SS10LV6, SS10V1, SS10V6, SS96D1, SS96D2  
**Visteon** HS090L, HS090R

### S25-4101 Felt Wiper

Felt Ring OD 1.055"/26.8mm



**Calsonic** CSV613  
**Delphi** CVC-125, CVC-135, CVC-135E, CVC6  
**Sanden** SD505, SD507, SD507A2  
**Tama** TM08HD  
**Visteon** VS16, VS18M

### S25-4102 Felt Wiper

Ring OD 1.130"/28.7mm



**Delphi** SP10  
**Denso** 7SB16C  
**Diesel Kiki** DKS15CH, DKS17CH  
**Sanden** PXE13, PXE16, PXV16, SD508, SD510, SD5H09, SD5H11, SD5H13, SD6V12, SD708, SD709, SD709CA, SD709CP, SD7B10, SD7C16, SD7H13, SD7H15, SD7V16  
**Seiko-Seiki** SS121DN1, SS121DN2, SS121DV2, SS96D1, SS96D2

## Shaft Seals

**S25-4103** Felt Wiper  
Ring OD 1.203"/30.5mm



Seiko-Seiki SS170PSS

**S13-1106** Lip Seal-HNBR  
GM Rubber Coated Lip Seal



Delphi SP15

**S20-1006** Lip Seal-HNBR



Calsonic DKV14D

Denso 10PA15 Series, 10PA17 Series, 10PA20C, 10PA20H, 10PA20J, 10PA20SC, 10PA20SH, 10PA20VC

Diesel Kiki DCV14J, DKV11G, DKV14G

Nihon DKV14C

**S20-1007** Lip Seal-HNBR



Calsonic CWV615, CWV617, CWV618

Denso 5SE09C, 5SE12C, 5SL12CJ, 6SEU12, 6SEU12C, 6SEU14C, 6SEU16, 7SBU16C, 7SBU17C, 7SE16, 7SEU16, 7SEU17C

**S20-1008** Lip Seal-HNBR



Denso 10S11C, 10S11P, 10S13C, 10S13P, 10S15C, 10S15L, 10S17C, 10S20C, 10S20F, 10S20H, 10SR15C, 10SR17C

**S20-2115** Lip Seal-HNBR



Denso TV12C(R134), TV12SC(R134), TV14SC

**S25-1001** Lip Seal-HNBR



Delphi SP10

Denso 6CA17C, 7SB16C

Diesel Kiki DKS13CH, DKS15CH, DKS17CH

Hadsys RC17D, RC17S

Sanden SD5H11, SD5H13, SD6V12, SD708, SD709, SD709CA, SD709CP, SD7B10, SD7H13, SD7H15, SD7V16

Seiko-Seiki SS121DN1, SS121DN2, SS121DV2, SS96D1

Tama TM08HD

**S30-1110** Lip Seal-HNBR



Calsonic CR14, CSV613

Daewoo V5

Delphi CVC-125, CVC-135, CVC-135E, CVC-165, CVC-185, CVC6, CVC7P

Denso SC08 (ITALY), SC08C (SPAIN), SC08C (USA), SCS06C, SCSA06, SCSC06

Diesel Kiki DCW17B, DCW17D, DKS17D

GM/Harrison V7, V7 (DESTROKER)

Sanden PXE13, PXE16, PXV16, SD5H11, SD5H13, SD7C16, SD7H15, SD7V16

Seiko-Seiki SS10LV6, SS10V1, SS10V6, SS96D2

Tama TM08, TM08HD

Zexel DCS17E, DCS17IC

**S30-1115** Lip Seal-HNBR



Diesel Kiki DKS16H(R134A)

**S30-1116** Lip Seal-HNBR

Lip Seal



**S50-1000** Lip Seal-HNBR



Mats/Pan N1300AC4, N1301AB4, N1301AD4, N1301AE4, NL1300AA4, NL1300AB4, NL1300AE4

**S65-1100** Lip Seal-HNBR



Hitachi A5000, MJS170

**S12-1005** Lip Seal-Nitrile



Ford F500, FS10, FS18, FX15

Visteon HS15, HS17, HS18, VS12M, VS16, VS18M

**S12-1006** Lip Seal-Nitrile

O.E. Lip Seal



Ford F500, FS10, FS18, FX15

Visteon HS15, HS17, HS18, VS12M, VS16, VS18M

**S13-1001** Lip Seal-Nitrile

GM Lip Seal (Single) (O.E.)



Calsonic V5-15C, V5-15F, V5-15G

GM/Harrison DA6, HD6, HR6, HR6HE, HT6, R4, V5, V5 (DESTROKER)

**S13-1002** Lip Seal-Nitrile

GM Double Lip Seal



Calsonic V5-15C, V5-15F, V5-15G

GM/Harrison DA6, HD6, HR6, HR6HE, HT6, R4, V5, V5 (DESTROKER)

**S13-1004** Lip Seal-Nitrile

GM HU6 Fat Shaft Lip Seal



GM/Harrison HT6, HU6

**S13-1005** Lip Seal-Nitrile

GM Rubber Coated Lip Seal



Daewoo V5

GM/Harrison V5

**S20-1005** Lip Seal-Nitrile



Denso 10PA15 Series, 10PA17 Series, 10PA20C, 10PA20H, 10PA20J, 10PA20SC, 10PA20SH, 10PA20VC

**S20-1010** Lip Seal-Nitrile

Triple Lip Seal



Calsonic CWV615, CWV617, CWV618

Chrysler 6C17

Denso 10P08E, 10P13 Series, 10P15 Series

GM/Harrison V7

Seiko-Seiki SS170PSS

**S25-1000** Lip Seal-Nitrile



Mats/Pan H12A1AH4DX

Mitsubishi AX105VSR, FX105V, FX80,

FXA105VS, FXA105VSLR, FXA105VSR, FXA105VSSS, MSC105CVS, MSC105VSR, MSC90, MSC90C

Sanden TR090, TR105, TR105VS, TR70, TRF090, TRF105, TRS090, TRS105

## Shaft Seals

**S35-1000**

Lip Seal-Nitrile



Seiko-Seiki SS170PSS

**S45-1002**

Lip Seal-Nitrile



Use with S45-6002

Nihon NVR140S

**S55-1001**

Lip Seal-Nitrile



Ford LARGE SCROLL, SCROLL  
Mitsubishi AX105VSR, FX105V, FX80,  
FXA105VS, FXA105VSLR,  
FXA105VSR, FXA105VSSS,  
MSC105CVS, MSC130CVSG,  
MSC130CVSG2, MSC90, MSC90C

Sanden TRSA09, TRSA12, TRSE07

Visteon HS090L, HS090R, HS110R

**S13-6101**

Seal Components



GM/Harrison A6, R4

**S30-6000**

Seal Components

Lip Seal Spacer



Delphi CVC-165, CVC-185, CVC7P

Seiko-Seiki SS96D2

Tama TM08HD

**S45-6002**

Seal Components

Use with S45-1002



Nihon NVR140S

**S45-6101**

Seal Components



Behr WINGCELL

Nihon DKV14B

**S11-3001**

Shaft Seal



Chrysler RV2

**S11-3101**

Shaft Seal



Chrysler A590, C171

Denso 10P08E, 10P13 Series, 10P15 Series, 10P17 Series, 10PA15A, 10PA15C, 10PA15E, 10PA15L, 10PA15LC, 10PA15SC, 10PA17A, 10PA17C, 10PA17E, 10PA17H, 10PA17J, 10PA17K, 10PA17SC, 10PA17SH, 6E171, 6E171A, 6P Series, TV10 Series, TV12CR

Ford FS6, FS6 CROSS MOUNT

Seiko-Seiki SS170PSS

**S13-3101**

Shaft Seal



GM/Harrison A6, R4

**S13-3102**

Shaft Seal



GM/Harrison A6, R4

**S25-3101**

Shaft Seal

Metal Shaft Seal Seat



Sanden SD507, SD507A2, SD508, SD510

**S25-3102**

Shaft Seal



Mitsubishi FX105V

Sanden SD505, SD5H09, TR090, TR105, TR105VS, TR70, TRF090, TRF105, TRS090, TRS105

**S25-3105**

Shaft Seal



Sanden SD708, SD709

**S30-3000**

Shaft Seal



Diesel Kiki DKS13G (DUAL), DKS13G (SINGLE), DKS15BH, DKS15G, DKS17G (DUAL), DKS17G (SINGLE)

**S30-3002**

Shaft Seal



Diesel Kiki DKS13S, DKS15S, DKS17S

**S40-3001**

Shaft Seal

6 Bolt - 7/32" Hole



Tecumseh HG500

York 206, 209, 210, SC206, SC209

**S40-3002**

Shaft Seal

6 Bolt - 9/32" Holes



Tecumseh HG1000, HG500, HG850

York 206, 209, 210

**S40-3003**

Shaft Seal

5 Bolt - 9/32" Holes



York 206, 209, 210

**S40-3004**

Shaft Seal



Tecumseh HG1000, HG850

**S45-3000**

Shaft Seal



Nihon NVR140S

**S50-3100**

Shaft Seal



Mats/Pan N1300AC4, N1301AB4, N1301AD4, N1301AE4, NL1300AA4, NL1300AB4, NL1300AE4, S1150F3, S1150X3, SA1150AE4

**S60-3000**

Shaft Seal



Keihin 150L, 150R

**K11-3001**

Black Nitrile

Carbon Seal Kit



Includes: Carbon Shaft Seal (1), Metal Shaft Seal Seat (1), Metal Shaft Seal Seat O-Ring (1), Nose Plate O-Ring (1)

Chrysler RV2

## Shaft Seals

### K12-3011 Black Nitrile

Lip Seal Kit



Includes: Lip Seal Retaining Ring (1), Shaft Bolt (1), Lip Seal (1), Felt Wiper (1), Lip Seal Protector (Plastic-16 Spline) (1).

**Ford** FS10, FS18, FX15

**Visteon** HS15, HS17, HS18

### K14-3000 Black Nitrile

Lip Seal Kit



Includes: Lip Seal Retaining Ring (1), Lip Seal (1)

**Visteon** VS16, VS18M

### K20-3005 Black Nitrile

Carbon Shaft Seal Kit



Includes: Shaft Seal Retaining Ring (1), Carbon Seal (1), Seal Seat (1), Shaft Seal Seat O-Ring (1), Head Bolt Washers (6), Valve Plate Gasket (1), Case O-Ring

**Denso** 6E171

### K20-3045 Black Nitrile

Alternate: K20-3145 (Green HNBR)

Lip Seal Kit



Includes: Shaft Seal Retaining Ring (1), Lip Seal (1), Head Bolt Washers (5), Case O-Ring (1)

**Denso** 10PA15C, 10PA17C

### K25-3017 Black Nitrile

Carbon Seal Kit



Includes: Carbon Shaft Seal (1), Metal Shaft Seal Seat (1), Metal Felt Ring (1), Metal Shaft Seal Seat O-Ring (1)

**Sanden** SD708, SD709

### K25-3156 Black Nitrile

Lip Seal Kit



Includes: Lip Seal (1), Lip Seal Felt Ring (1), Lip Seal Retaining Ring (1).

**Delphi** SP10

**Denso** 6CA17C, 7SB16C

**Diesel Kiki** DKS15CH, DKS17CH

**Sanden** SD5H09, SD5H11, SD5H13, SD6V12, SD708, SD709, SD709CA, SD709CP, SD7B10, SD7H13, SD7H15, SD7V16

**Seiko-Seiki** SS121DN1, SS121DN2, SS121DV2, SS96D1, SS96D2

**Tama** TM08, TM08HD

### K30-3006 Black Nitrile

Lip Seal Kit



Includes: Lip Seal Retaining Ring (1), Lip Seal (1)

**Diesel Kiki** DKS16H(R134A)

### K30-3008 Black Nitrile

Lip Seal Kit



Includes: Lip Seal Retaining Ring (1), Felt Ring (1), Lip Seal (1)

**Calsonic** CSV613

**Delphi** CVC-125, CVC-135, CVC-135E, CVC6

### K35-3010 Black Nitrile

Lip Seal Kit



Includes: Lip Seal (1), Lip Seal Retaining Ring (1).

**Seiko-Seiki** SS170PSS

### K40-3005 Black Nitrile

Carbon Seal Kit (Large Front Bearings)



Includes: Plate Lathe Cut Seal (1), Carbon Shaft Seal (1), Metal Shaft Seal Seat (1)

**Tecumseh** HG1000, HG850

### K40-3015 Black Nitrile

Carbon Seal Kit (6 Bolt - 7/32" Holes)



Includes: Seal Plate O-Ring (1), Carbon Shaft Seal (1), Shaft Seal Plate (6 Bolt - 7/32" Holes) (1)

**Tecumseh** HG500

**York** 206, 209, 210, SC206, SC209

### K40-3020 Black Nitrile

Carbon Seal Kit (6 Bolt - 9/32" Holes)



Includes: Seal Plate Gasket - Circular (1), Carbon Shaft Seal (1), Shaft Seal Plate - 6 Bolt - 9/32" Holes (1), Dust Shield (1), Plate Lathe Cut Seal (1).

**Tecumseh** HG1000, HG500, HG850

**York** 206, 209, 210

## Shaft Seals

### K40-3025 Black Nitrile

Carbon Seal Kit (5 Bolt)



Includes: Seal Plate Lathe Cut Seal (1), Carbon Shaft Seal (1), Shaft Seal Plate (5 Bolt - 9/32" Holes) (1).

**York** 206, 209, 210

### K55-3006 Black Nitrile

Lip Seal Kit



Includes: Lip Seal Retaining Ring (1), Lip Seal (1)

**Ford** LARGE SCROLL, SCROLL  
**Mitsubishi** AX105VSR, FX105V, FX80, FXA105VS, FXA105VSLR, FXA105VSR, FXA105VSSS, MSC105CVS, MSC130CVSG, MSC130CVSG2, MSC90, MSC90C

**Sanden** TRSA09, TRSA12, TRSE07

**Visteon** HS090L, HS090R, HS110R

### K55-3110 Black Nitrile

Lip Seal Kit



Includes: Lip Seal Retaining Ring (1), Lip Seal (1)

**Mitsubishi** AX105VSR, FX105V, FX80, FXA105VS, FXA105VSLR, FXA105VSR, FXA105VSSS, MSC105CVS, MSC105VSR, MSC90, MSC90C

**Sanden** TR090, TR105, TR105VS, TR70, TRF090, TRF105, TRS090, TRS105

### K60-2000 Black Nitrile

Shaft Seal Kit



Includes: Carbon Shaft Seal O-Ring (1), Metal Shaft Seal O-Ring (1), Carbon Ring (1), Metal Shaft Seal seat (1), Metal Shaft Seal Retaining Ring (1).

**Keihin** 150L, 150R

### K12-3105 Green HNBR

Alternate: K12-3005 (Black Nitrile)

FS6 Carbon Shaft Seal Kit with Gaskets - HNBR

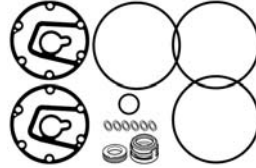

Includes: Head Bolt Washer (6), Valve Plate Gasket - Metal (2), Shaft Seal Seat O-ring (1), Case O-Ring (3), Carbon Seal (1), Metal Seal Seat (1)

**Ford** FS6

### K13-3105 Green HNBR

Alternate: K13-3005 (Black Nitrile)

Carbon Seal Kit



Includes: Carbon Shaft Seal (1), Ceramic Shaft Seal Seat (1), Shaft Seal Seat O-Ring (1), Shaft Seal Retaining Ring (1), Felt Wiper (1), Felt Wiper Retainer (1)

**GM/Harrison A6**

### K13-3110 Green HNBR

Alternate: K13-3010 (Black Nitrile)

Carbon Seal Kit



Includes: Shaft Seal Seat Retaining Ring (Beveled) (1), Carbon Shaft Seal (1), Metal Shaft Seal Seat (1), Shaft Seal Seat O-Ring (1)

**GM/Harrison A6, R4**

### K13-3115 Green HNBR

Alternate: K13-3015 (Black Nitrile)

Carbon Seal Kit



Includes: Carbon Shaft Seal (1), Metal Shaft Seal Seat (1), Shaft Seal Seat O-Ring (1), Shaft Seal Retaining Ring (1), Felt Wiper (1), Felt Wiper Retainer (1)

**GM/Harrison A6**

### K13-3120 Green HNBR

Alternate: K13-3020 (Black Nitrile)

Carbon Seal Kit (Ceramic Seat)



Includes: Shaft Seal Seat Retaining Ring (Beveled) (1), Carbon Shaft Seal (1), Ceramic Shaft Seal Seat (1), Shaft Seal Seat O-Ring (1)

**GM/Harrison A6, R4**

### K13-3125 Green HNBR

Alternate: K13-3025 (Black Nitrile)

Lip Seal Kit (Single Lip Seal)



Includes: Lip Seal Retaining Ring (1), Lip Seal O-Ring (1), Lip Seal (1)

**Calsonic** V5-15C, V5-15F, V5-15G

**GM/Harrison** DA6, HD6, HR6, HR6HE, HT6, R4, V5, V5 (DESTROKER)

### K13-3126 Green HNBR

Alternate: K13-3026 (Black Nitrile)

Lip Seal Kit (Double Lip Seal)



Includes: Double Lip Seal (1), Double Lip Seal O-Ring - Small (1), Double Lip Seal O-Ring - Large (1), Retaining Ring (1),

**GM/Harrison** HD6, HT6

## Shaft Seals

### K13-3127 Green HNBR

Alternate: K13-3027 (Black Nitrile)

Lip Seal Kit



Includes: Shaft Seal Retaining Ring (1), Lip Seal (1), Lip Seal O-Ring (1).

GM/Harrison V7

### K13-3128 Green HNBR

GM HU6 Fat Shaft Lip Seal



Includes: Lip Seal Retaining Ring (1), Lip Seal O-Ring (1), Lip Seal (1)

GM/Harrison HU6

### K13-3129 Green HNBR

Lip Seal Kit



Includes: Lip Seal Retaining Ring (1), Lip Seal (1)

Daewoo V5

Denso SCSA06, SCSC06

GM/Harrison V7

### K13-3130 Green HNBR

Lip Seal Kit (Rubber Coated)



Includes: Lip Seal Retaining Ring (1), Lip Seal (1)

GM/Harrison V5

### K20-3100 Green HNBR

Lip Seal Kit



Includes: Shaft Seal Retaining Ring (1), Lip Seal (1)

Calsonic CWV615, CWV617, CWV618

Denso 5SE09C, 5SE12C, 5SL12CJ, 6SEU12, 7SBU16C, 7SBU17C, 7SE16, 7SEU16, 7SEU17C

### K20-3115 Green HNBR

Alternate: K20-3015 (Black Nitrile)

Carbon Seal Kit



Includes: Head Bolt Washer (6), Lip Seal/Metal Shaft Seal Retaining Ring (1), Lip Seal/Metal Shaft Seal Seat O-Ring (Pre-92) (1), Carbon Shaft Seal (Pre-92) (1), Metal Shaft Seal Seat (1)

Chrysler A590, C171

Denso 10P08E, 10P13 Series, 10P15 Series, 10P17 Series, 10PA15A, 10PA15C, 10PA15E, 10PA15L, 10PA15LC, 10PA15SC, 10PA17A, 10PA17C, 10PA17E, 10PA17H, 10PA17J, 10PA17K, 10PA17SC, 10PA17SH, 6E171, 6E171A, 6P Series

Ford FS6, FS6 CROSS MOUNT

### K20-3130 Green HNBR

Alternate: K20-3030 (Black Nitrile)

Lip Seal Kit



Includes: Lip Seal Retaining Ring (1), Lip Seal (1), Lip Seal O-Ring (1).

Chrysler 6C17

Denso 10P08E, 10P13 Series, 10P15 Series

Seiko-Seiki SS170PSS

### K20-3135 Green HNBR

Alternate: K20-3035 (Black Nitrile)

Carbon Seal Kit

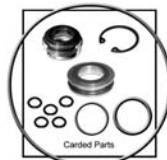

Includes: Head Bolt Washer (5), Metal Shaft Seal Seat Retaining Ring (1), Metal Shaft Seal Seat O-Ring (1), Carbon Shaft Seal (1), Metal Shaft Seal Seat (1), Case O-Ring (1), Valve Plate O-Ring (1)

Denso 10P13C, 10P15C

### K20-3145 Green HNBR

Alternate: K20-3045 (Black Nitrile)

Lip Seal Kit



Includes: Head Bolt Washer (5), Metal Shaft Seal Seat Retaining Ring (1), Lip Seal (1), Case O-Ring (1)

Denso 10PA15C, 10PA17C

### K20-3146 Green HNBR

Lip Seal Kit



Includes: Lip Seal (1), Lip Seal Retaining Ring (1).

Denso 10PA15A, 10PA15C, 10PA15E, 10PA15L, 10PA15LC, 10PA15SC, 10PA15VC, 10PA17A, 10PA17C, 10PA17E, 10PA17H, 10PA17J, 10PA17K, 10PA17SC, 10PA17SH, 10PA17VC, 10PA17VSC, 10PA20C, 10PA20H, 10PA20J, 10PA20SC, 10PA20SH, 10PA20VC

### K20-3147 Green HNBR

Lip Seal Kit



Includes: Lip Seal (1), Lip Seal Retaining Ring (1).

Denso 10PA15A, 10PA15C, 10PA15E, 10PA15L, 10PA15LC, 10PA15SC, 10PA15VC, 10PA17A, 10PA17C, 10PA17E, 10PA17H, 10PA17J, 10PA17K, 10PA17SC, 10PA17SH, 10PA17VC, 10PA17VSC, 10PA20C, 10PA20H, 10PA20J, 10PA20SC, 10PA20SH, 10PA20VC



## Shaft Seals

### K20-3148 Green HNBR

Lip Seal Kit



Includes: Lip Seal (1).

**Denso** 10S11C, 10S11P, 10S13C, 10S13P, 10S15C, 10S15L, 10S17C, 10S20C, 10S20F

### K20-3149 Green HNBR

Lip Seal Kit



Includes: Retaining Ring (1), Lip Seal (1), Felt Wiper (1)

**Denso** 5SE09C, 5SE12C, 6SEU12, 6SEU12C, 6SEU14C, 6SEU16, 7SE16, 7SEU16

### K20-3155 Green HNBR

Lip Seal Kit



Includes: Retaining Ring (1), Lip Seal (1)

**Denso** TV12C(R134), TV12SC(R134), TV14SC

### K20-3156 Green HNBR

Carbon Ring Only Shaft Seal Kit



Includes: Carbon Ring (1), Carbon Shaft Seal O-Ring (1).

**Denso** TV12C(R12), TV12EC(R12), TV14C, TV14EC

### K25-3105 Green HNBR

Alternate: K25-3005 (Black Nitrile)  
Carbon Seal Kit



Includes: Carbon Shaft Seal (1), Metal Shaft Seal Seat (1), Shaft Seal Seat O-Ring (1), Metal Shaft Seal Seat Retaining Ring (1)

**Sanden** SD507, SD507A2, SD508, SD510

### K25-3110 Green HNBR

Alternate: K25-3010 (Black Nitrile)  
Carbon Seal Kit



Includes: Carbon Shaft Seal (1), Mini Metal Shaft Seal Seat (1), Metal Shaft Seal Seat O-Ring (1)

**Sanden** SD505, TR090, TR105, TR105VS, TR70, TRF090, TRF105, TRS090, TRS105

### K30-1110 Green HNBR

Lip Seal Kit



Includes: Lip Seal Retaining Ring (1), Lip Seal Metal Spacer (1), Lip Seal (1)

**Delphi** CVC-165, CVC-185, CVC7P

**Diesel Kiki** DCW17B, DCW17D, DKS17D

**Sanden** PXE13, PXE16, PXV16, SD5H09, SD5H11, SD5H13, SD7C16, SD7H15, SD7V16

**Seiko-Seiki** SS10LV6, SS10V1, SS10V6, SS96D1, SS96D2

**Tama** TM08, TM08HD

**Zexel** DCS17E

### K30-3105 Green HNBR

Alternate: K30-3005 (Black Nitrile)  
Carbon Seal Kit



Includes: Shaft Seal Retaining Ring (1), Carbon Shaft Seal (1), Metal Shaft Seal Seat (1), Metal Shaft Seal Seat O-Ring (1)

**Diesel Kiki** DKS13G (DUAL), DKS13G (SINGLE), DKS15BH, DKS15G, DKS17G (DUAL), DKS17G (SINGLE)

### K30-3107 Green HNBR

Alternate: K30-3007 (Black Nitrile)  
Carbon Seal Kit



Includes: Shaft Seal Retaining Ring (1), Carbon Shaft Seal (1), Metal Shaft Seal Seat (1), Metal Shaft Seal Seat O-Ring (1)

**Diesel Kiki** DKS13S, DKS15S, DKS17S

### K35-3105 Green HNBR

Alternate: K35-3005 (Black Nitrile)  
Carbon Seal Kit



Includes: Shaft Seal Retaining Ring (1), Carbon Shaft Seal (1), Metal Shaft Seal Seat (1), Metal Shaft Seal Seat O-Ring (1)

**Seiko-Seiki** SS170PSS

### K40-3110 Green HNBR

Alternate: K40-3010 (Black Nitrile)  
Carbon Seal Kit



Includes: Shaft Seal Retaining Ring (1), Carbon Seal (1), Metal Shaft Seal Seat (1), Shaft Seal Seat O-Ring (1)

## Shaft Seals

### K40-3130 Green HNBR

Alternate: K40-3030 (Black Nitrile)  
Carbon Seal Kit



Includes: Shaft Seal Retaining Ring (1)  
Carbon Seal (1), Metal Shaft Seal Seat  
(1), Shaft Seal Seat O-Ring (1)

### K45-3105 Green HNBR

Alternate: K45-3005 (Black Nitrile)  
Carbon Seal Kit



Includes: Carbon Ring (1), Shaft Seal  
Spring(1), Carbon Shaft Seal O-Ring (1),  
Metal Shaft Seal Seat O-Ring (1)

**Behr** WINGCELL  
**Nihon** DKV14B

### K45-3106 Green HNBR

Lip Seal Kit



Includes: Lip Seal (1), Teflon Shaft Seal  
(1)

**Nihon** NVR140S

### K45-3107 Green HNBR

Lip Seal Kit



Includes: Lip Seal Retaining Ring (1), Lip  
Seal (1)

**Calsonic** DKV14D  
**Diesel Kiki** DCV11A, DCV14A, DKV11A  
**Nihon** DKV14B, DKV14C

### K50-3100 Green HNBR

Carbon Seal Kit



Includes: Carbon Shaft Seal (1), Metal  
Shaft Seal Seat (1), Metal Shaft Seal  
Seat O-Ring (1)

**Mats/Pan** N1300AC4, N1301AB4,  
N1301AD4, N1301AE4, NL1300AA4,  
NL1300AB4, NL1300AE4, S1150F3,  
S1150X3, SA1150AE4

### K50-3101 Green HNBR

Lip Seal Kit



Includes: Lip Seal (1), Shaft Seal  
Retaining Ring (1)

**Mats/Pan** N1300AC4, N1301AB4,  
N1301AD4, N1301AE4, NL1300AA4,  
NL1300AB4, NL1300AE4

### K55-3105 Green HNBR

Alternate: K55-3005 (Black Nitrile)  
Carbon Seal Kit

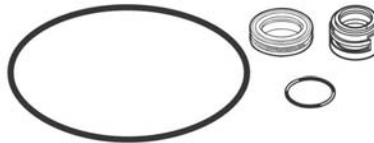

Includes: Carbon Shaft Seal (1), Metal  
Shaft Seal Seat (1), Nose Plate O-Ring  
(1), Metal Shaft Seal Seat O-Ring (1)

**Mitsubishi** FX105V

### K95-3100 Green HNBR

Lip Seal Kit



Includes: Lip Seal Retaining Ring (1), Lip  
Seal (1)

**Hadsys** RC17D, RC17S

## Shipping Closures

### C10-1000 Cap

Black Plastic Cap - 1/4" Fitting



- Chrysler** A590, C171
- Denso** 10P08E, 10P13 Series, 10P15 Series, 6E171, 6E171A, 6P127A, 6P127B, 6P127D, 6P134
- Diesel Kiki** DCW17B, DCW17D, DKS15CH
- Ford** FS6, FS6 CROSS MOUNT
- GM/Harrison VIR**
- Hitachi** MJ110, MJ167, MJS130, SWP123
- Keihin** 150L, 150R
- Mitsubishi** FX105V, FX80
- Sanden** SD708, SD709, SD709CA
- Seiko-Seiki** SS170PSS

### C10-1001 Cap

High Side Cap 3/16" Fitting (Black Plastic)



### C10-1110 Cap

Soft Cap - Blue - 0.400" x 1/2" Deep



### C10-1120 Cap

Metal Cap - 7/16" Permanent



- Diesel Kiki** DKS15CH
- Hitachi** MJ110, MJ167, MJS130, SWP123

### C12-1100 Cap

Yellow Plastic Plug



- Ford** FS6, FS6 CROSS MOUNT

### C13-1152 Cap

Red Plastic Cap



- GM/Harrison VIR**

### C13-1153 Cap

Black Plastic Cap - M12 x 1.5



- GM/Harrison VIR**

### C13-1156 Cap

Black Plastic Cap - 1 1/16" Fitting



- Behr** WINGCELL

### C20-1000 Cap

Blue Plastic Cap



- Denso** 10PA15 Series, 10PA17 Series, 10PA20C, 10PA20H, 10PA20J, 10PA20SC, 10PA20SH, 10PA20VC, 10S11C, 10S11P, 10S13C, 10S13P, 10S15C, 10S15L, 10S17C, 10S20C, 10S20F, 10S20H, TV10 Series, TV12 Series, TV14 Series

### C25-1110 Cap

Black Plastic Cap - 3/4" x 16 w/ O-Ring



- Denso** 10P13 Series, 10P15 Series
- Diesel Kiki** DKS15BH, DKS15CH
- Hitachi** SWP123
- Keihin** 150R
- Sanden** SD505, SD507, SD507A2, SD508, SD510, SD708, SD709
- Tama** TM08HD

### C25-1111 Cap

Black Plastic Cap - 7/8" x 14 w/Disc



- Denso** 10P13 Series, 10P15 Series
- Diesel Kiki** DKS15BH, DKS15CH
- Keihin** 150R
- Sanden** SD505, SD507, SD507A2, SD508, SD510, SD5H11, SD708, SD709
- Tama** TM08HD

### C25-1112 Cap

Black Plastic Cap - 3/4"x 16 Flare



- Behr** WINGCELL
- Denso** 10P13 Series, 10P15 Series
- Diesel Kiki** DKS15BH, DKS15CH
- Hitachi** MJ110, MJ123, MJ167, MJS130
- Keihin** 150R
- Sanden** SD505, SD507, SD507A2, SD508, SD510, SD5H11, SD708, SD709
- Tama** TM08HD

### C25-1113 Cap

Black Plastic Cap - 7/8" x 14 Flare w/Disc



- Bosch** AXIAL
- Denso** 10P13 Series, 10P15 Series
- Diesel Kiki** DKS15BH, DKS15CH
- Keihin** 150R
- Sanden** SD505, SD507, SD507A2, SD508, SD510, SD708, SD709
- Tama** TM08HD

### C25-1115 Cap

- Sanden** SD709



### C25-1116 Cap

- Sanden** SD709



### C30-1101 Cap

Shipping Cap, Vinyl - Discharge Port



- Diesel Kiki** DCW17B, DCW17D

### C30-1102 Cap

Yellow Plastic Plug



- Diesel Kiki** DCW17B, DCW17D

### C30-1103 Cap

Shipping Cap, Vinyl - Suction Port



- Diesel Kiki** DCW17B, DCW17D

### C40-1101 Cap

Black Plastic Cap



- Tecumseh** HG1000, HG850
- York** 206, 209, 210

### C40-1110 Cap

Black Plastic Cap w/Disc



- Sanden** SD5H13, SD708, SD709
- Tecumseh** HG1000, HG500, HG850
- York** 206, 209, 210, SC206, SC209

### C50-1101 Cap

Red Plastic Cap

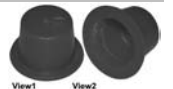

- Mats/Pan** S1150F3, S1150X3

### C50-1102 Cap

Red Plastic Cap

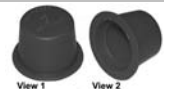

- Mats/Pan** S1150F3, S1150X3

### C11-3000 Pad

- Chrysler** RV2



## Shipping Closures

### C11-3101 Pad



**Chrysler** A590, C171  
**Sanden** SD709CA

### C11-3102 Pad



**Calsonic** DKV14D  
**Chrysler** 6C17  
**Hitachi** A5000, MJ110, MJ167, MJS130, MJS170, SWP167  
**Nihon** DKV14C, NVR140S  
**Tecumseh** HG1000, HG850  
**York** 206, 209, 210

### C11-3103 Pad



**Behr** WINGCELL  
**Calsonic** CWV615, CWV617, CWV618, V5-15C, V5-15F, V5-15G  
**Denso** 7SB16C, 7SBU16C, 7SE16, 7SEU16, 7SEU17C  
**Diesel Kiki** DKS16H(R12), DKS16H(R134A)  
**Keihin** 150L  
**Mitsubishi** FX105V, MSC105CVS  
**Nihon** DKV14B, DKV14C  
**Sanden** PXE13, PXE16, PXV16, SD709CP, TR090, TR105, TR105VS, TR70, TRF090, TRF105, TRS090, TRS105  
**Visteon** VS16  
**York** SC206, SC209  
**Zexel** DCS17E

### C12-3100 Pad

2 Required



**Denso** 10P13 Series, 10P15 Series, 10P17 Series, 6E171, 6E171A, 6P Series  
**Ford** FS6, FS6 CROSS MOUNT

### C13-3000 Pad



**Delphi** CVC-125, CVC-135, CVC-135E, CVC-165, CVC-185, CVC6, CVC7P  
**Denso** 10PA15C, 6CA17C  
**Diesel Kiki** DKS13G (DUAL), DKS13G (SINGLE), DKS13S, DKS15G, DKS15S, DKS17CH, DKS17G (DUAL), DKS17G (SINGLE), DKS17S  
**Ford** FS10, FS6, FS6 CROSS MOUNT, FX15

**GM/Harrison** A6, DA6, HR6, HR6HE, R4, V5, V5 (DESTROKER)

**Sanden** SD6V12, SD7H15, SD7V16, TR090, TRS090

**Seiko-Seiki** SS170PSS

### C20-3101 Pad



**Denso** 10P08E

### C20-3102 Pad



**Denso** 10PA15 Series, 10PA17A, 10PA17C, 10PA17E, 10PA17H, 10PA17J, 10PA17K, 10PA17SC, 10PA17SH, 10PA17VC, 10PA17VSC, 10PA20C, 10PA20H, 10PA20J, 10PA20SC, 10PA20SH, 10PA20VC

### C40-3100 Pad



**Keihin** 150L

### C40-3101 Pad



**Tecumseh** HG1000, HG500, HG850  
**York** 206, 209, 210, SC206, SC209

### C50-3001 Pad



**Calsonic** CR14, DKV14D, V5-15C, V5-15F, V5-15G

**Delphi** SP10

**Denso** 10S11C, 10S11P, 10S13C, 10S13P, 10S15C, 10S15L, 10S17C, 10S20C, 10S20F, 10S20H, 5SE09C, 5SE12C, 7SB16C, 7SBU16C, SC08 (ITALY), SC08C (SPAIN), SC08C (USA), TV10 Series, TV12 Series, TV14 Series

**Diesel Kiki** DCV11A, DCV14A, DKS16H(R12), DKS16H(R134A), DKV11A

**Keihin** 150L

**Mats/Pan** H12A1AH4DX, N1300AC4, N1301AB4, N1301AD4, N1301AE4, NL1300AA4, NL1300AB4, NL1300AE4, S1150F3, S1150X3, SA1150AE4

**Mitsubishi** AX105VSR, FX80, FXA105VS, FXA105VSLR, FXA105VSR, FXA105VSSS, MSC105CVS, MSC90, MSC90C

**Sanden** SD7B10, TR090, TR105, TR105VS, TR70, TRF090, TRF105, TRS090, TRS105

**Seiko-Seiki** SS96D1, SS96D2

### C11-4100 Plate (Metal)

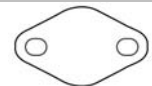

**Chrysler** RV2

### C11-4101 Plate (Metal)



**Chrysler** A590, C171  
**Sanden** SD709CA

### C11-4102 Plate (Metal)

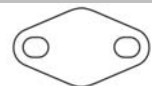

**Calsonic** DKV14D  
**Chrysler** 6C17  
**Hitachi** A5000, MJ110, MJ167, MJS130, MJS170, SWP167  
**Nihon** DKV14C, NVR140S  
**Tecumseh** HG1000, HG850  
**York** 206, 209, 210

### C11-4103 Plate (Metal)



**Behr** WINGCELL  
**Calsonic** CWV615, CWV617, CWV618, V5-15C, V5-15F, V5-15G  
**Denso** 7SB16C, 7SBU16C, 7SE16, 7SEU16, 7SEU17C  
**Diesel Kiki** DKS16H(R12), DKS16H(R134A)  
**Keihin** 150L  
**Mitsubishi** FX105V, MSC105CVS  
**Nihon** DKV14B, DKV14C  
**Sanden** PXE13, PXE16, PXV16, SD709CP, TR090, TR105, TR105VS, TR70, TRF090, TRF105, TRS090, TRS105  
**Visteon** VS16  
**York** SC206, SC209  
**Zexel** DCS17E

### C12-4100 Plate (Metal)

Single Side



**Denso** 10P17 Series, 6E171, 6E171A, 6P Series

**Ford** FS6, FS6 CROSS MOUNT

### C12-4101 Plate (Metal)

Double Side



**Denso** 10P17 Series, 6E171, 6E171A, 6P Series

## Shipping Closures

**Ford** FS6, FS6 CROSS MOUNT  
**C12-4102** Plate (Metal)



**Ford** FS6, FS6 CROSS MOUNT  
**C12-4105** Plate (Metal)



**Diesel Kiki** DKS13G (DUAL), DKS13G (SINGLE), DKS15G, DKS17CH

**Ford** FS10, FX15

**C13-4100** Plate (Metal)



**Delphi** CVC-125, CVC-135, CVC-135E, CVC-165, CVC-185, CVC6, CVC7P

**Diesel Kiki** DKS17G (DUAL), DKS17G (SINGLE)

**GM/Harrison** A6, DA6, HD6, HR6, HR6HE, HT6, R4, V5, V5 (DESTROKER)

**Sanden** SD7H15, SD7V16

**Seiko-Seiki** SS170PSS

**C13-4101** Plate (Metal)

Rounded Ends

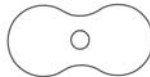

**Denso** 6CA17C

**Diesel Kiki** DKS13S, DKS15S, DKS17G (DUAL), DKS17G (SINGLE), DKS17S

**GM/Harrison** A6, R4

**Sanden** SD6V12, SD7H15, SD7V16

**Seiko-Seiki** SS170PSS

**C20-4100** Plate (Metal)



**Denso** 10P13 Series, 10P15 Series

**C20-4101** Plate (Metal)



**Denso** 10P08E

**C20-4102** Plate (Metal)



**Denso** 10PA15 Series, 10PA17A, 10PA17C, 10PA17E, 10PA17H, 10PA17J, 10PA17K, 10PA17SC, 10PA17SH, 10PA17VC, 10PA17VSC, 10PA20C, 10PA20H, 10PA20J, 10PA20SC, 10PA20SH, 10PA20VC

**C25-4105** Plate (Metal)



**Denso** 10PA15C

**Sanden** TR090, TRF090, TRS090

**C50-4101** Plate (Metal)



**Calsonic** CR14, DKV14D, V5-15C, V5-15F, V5-15G

**Delphi** SP10

**Denso** 10S11C, 10S11P, 10S13C, 10S13P, 10S15C, 10S15L, 10S17C, 10S20C, 10S20F, 10S20H, 5SE09C, 5SE12C, 7SB16C, 7SBU16C, SC08 (ITALY), SC08C (SPAIN), SC08C (USA), TV10 Series, TV12 Series, TV14 Series

**Diesel Kiki** DCV11A, DCV14A, DKS16H(R12), DKS16H(R134A), DKV11A

**Keihin** 150L

**Mats/Pan** H12A1AH4DX, N1300AC4, N1301AB4, N1301AD4, N1301AE4, NL1300AA4, NL1300AB4, NL1300AE4, S1150F3, S1150X3, SA1150AE4

**Mitsubishi** AX105VSR, FX80, FXA105VS, FXA105VSLR, FXA105VSR, FXA105VSSS, MSC105CVS, MSC90, MSC90C

**Sanden** SD7B10, TR090, TR105, TR105VS, TR70, TRF090, TRF105, TRS090, TRS105

**Seiko-Seiki** SS96D1, SS96D2

**C60-4100** Plate (Metal)



**Keihin** 150L

**C95-4001** Plate (Metal)

Small - For 8 mm Bolt



**Calsonic** CR14, CSV613, CWV615, CWV617, CWV618, DKV14D, V5-15C, V5-15F, V5-15G

**Chrysler** 6C17, A590, C171

**Delphi** SP10, SP15

**Denso** 10P13 Series, 10P15 Series, 10P17 Series, 10SR15C, 10SR17C, 6E171, 6E171A, 6P Series, 6SEU12, 7SE16, 7SEU16, 7SEU17C, TV10 Series, TV12C(R12), TV12EC(R12), TV14C, TV14EC

**Diesel Kiki** DCV11A, DCV11D, DCV14A, DCV14J, DKS16H(R12), DKS16H(R134A), DKV11A, DKV11G, DKV14G, DKV14J

**Ford** FS18

**Hadsys** RC17D, RC17S

**Hitachi** A5000, MJS170, SWP167

**Mats/Pan** N1301AB4, N1301AD4, N1301AE4, NL1300AA4, NL1300AE4, SA1150AE4

**Mitsubishi** FX105V, FX80, MSC130CVSG, MSC130CVSG2, MSC90, MSC90C

**Nihon** NVR140S

**Sanden** PXE13, PXE16, PXV16, SD5H09, SD709CA, SD709CP, TR090, TR70, TRF090, TRS090, TRSA09, TRSE07

**Seiko-Seiki** SS121DN1, SS121DN2, SS121DV2, SS96D1, SS96D2

**Visteon** HS15, HS17, HS18, VS16, VS18M

**York** SC206, SC209

**Zexel** DCS17E

**C95-4002** Plate (Metal)

Small - For 6mm Bolt



**Denso** 10S11C, 10S11P, 10S13C, 10S13P, 10S15C, 10S15L, 10S17C, 10S20C, 10S20F, 10S20H, 5SE09C, 5SE12C, 5SL12CJ, 6SEU12C, 6SEU14C, 6SEU16, SC08 (ITALY), SC08C (SPAIN), SC08C (USA), SCS06C, SCSA06, SCSC06, TV12C(R134), TV12SC(R134), TV14SC

**Mats/Pan** H12A1AH4DX, S1150F3

**Nihon** DKV14C

**Sanden** SD7B10, SD7C16

**Seiko-Seiki** SS10LV6, SS10V1, SS10V6

**Visteon** HS090L, HS090R, HS110R, HS17, HS18

**C12-5102** Plate (Plastic)

OE Plastic Shipping Closure



**Ford** FS10, FX15, LARGE SCROLL, SCROLL

**C13-5100** Plate (Plastic)

O.E. Plastic Shipping Closure - 5/8" Ports (Black)



**Daewoo** V5

**GM/Harrison** DA6, HR6, HR6HE, R4, V5, V5 (DESTROKER)

**C13-5101** Plate (Plastic)

O.E. Plastic Shipping Closure - 5/8" Ports (Tan)



**GM/Harrison** DA6, HD6, HR6, HR6HE, HT6, HU6, R4, V5, V5 (DESTROKER)

## Shipping Closures

### C13-5102

Plate (Plastic)

O.E. 3/4" Suction - 5/8"  
Discharge (Orange)



**GM/Harrison** HU6, R4, V5, V5  
(DESTROKER), V7

**Sanden** TRSA12

### C13-5103

Plate (Plastic)

O.E. 5/8" Suction - 3/4"  
Discharge



**GM/Harrison** R4, V5, V5 (DESTROKER)

### C20-5004

Plate (Plastic)

Green Plastic Plug

**Denso** 10S11C, 10S13C, 10S15C,  
10S17C, 10S20C

### C20-5005

Plate (Plastic)

Green Plastic Plug

**Denso** 10S11C, 10S13C, 10S15C,  
10S17C, 10S20C

### C11-2100

Plug

Yellow Plastic Plug



**Chrysler** A590, C171

**Diesel Kiki** DCW17B, DCW17D

### C13-2111

Plug

Aluminum Dummy Plug



**Chrysler** 6C17

**Denso** 10S11C, 10S11P, 10S13C,  
10S13P, 10S15C, 10S15L, 10S17C,  
10S20C, 10S20F

**GM/Harrison** A6, DA6, HD6, HR6, HR6HE,  
HT6, HU6, R4, V5, V5 (DESTROKER)

### C13-2112

Plug

Hollow Dummy Plug



**GM/Harrison** DA6, HD6, HR6, HR6HE,  
HT6, HU6

### C13-2160

Plug

Red Plastic Plug



**GM/Harrison** VIR

### C13-2161

Plug

Red Plastic Plug



**GM/Harrison** VIR

### C13-2162

Plug

Red Plastic Plug



**GM/Harrison** VIR

### C13-2173

Plug

Clear Plastic Plug - 1 1/16" -  
w/O-Ring



**GM/Harrison** VIR

### C20-2000

Plug

Aluminum Plug - Use M96-  
2153



**Denso** 10P15C, 10PA15C,  
10PA15SC, 10PA17C, 10PA20C

### C20-2001

Plug

Aluminum Plug - 7/8" 14  
Flare - Use M20-1023



**Denso** 10P15C

### C95-2000

Plug

Steel Braze-On Plug



**Behr** WINGCELL

### C95-3002

Plug

Size 2



**Calsonic** CR14

**Delphi** SP15

**Denso** 10P17 Series, 6E171,  
6E171A, 7SE16, 7SEU16, 7SEU17C

**Diesel Kiki** DKS16H(R12), DKV11A,  
DKV14J

**Hadsys** RC17D, RC17S

**Mats/Pan** H12A1AH4DX

**Sanden** SD5H09, TR090

**Seiko-Seiki** SS121DN1, SS121DN2,  
SS121DV2, SS96D1, SS96D2

**Visteon** HS15, HS17, HS18

### C95-3003

Plug

Size 3



**Calsonic** CSV613, CWV615, CWV617,  
CWV618, DKV14D, V5-15C, V5-15F, V5-  
15G

**Denso** 10P13 Series, 10P15 Series,  
10S11C, 10S11P, 10S13C, 10S13P,  
10S15C, 10S15L, 10S17C, 10S20C,  
10S20F, 10S20H, 10SR15C, 10SR17C,  
5SE09C, 5SE12C, 5SL12CJ, 6E171,  
6E171A, 6P Series, 6SEU12, 6SEU12C,  
6SEU14C, 6SEU16, SC08 (ITALY), SCS0

**Diesel Kiki** DCV11A, DCV11D,  
DCV14A, DCV14J, DKS16H(R134A),  
DKV11G, DKV14G

**Ford** FS18

**Nihon** DKV14C, NVR140S

**Sanden** PXE13, PXE16, PXV16,  
SD5H09, SD709CP, SD7B10, SD7C16,  
TR090, TRSA09, TRSE07

**Visteon** HS090L, HS090R, HS110R,  
VS16, VS18M

**Zexel** DCS17E, DCS17IC

### C95-3004

Plug

Size 4



**Calsonic** CR14

**Chrysler** 6C17, A590, C171

**Delphi** SP10, SP15

**Denso** 10P13 Series, 10P15 Series,  
10P17 Series, 6P Series, 6SEU12,  
SC08C (SPAIN), SC08C (USA), TV10  
Series, TV12 Series, TV14 Series

**Diesel Kiki** DCV11A, DCV11D,  
DCV14A, DKS16H(R12),  
DKS16H(R134A), DKV11A

**Ford** FS18

**Hadsys** RC17D, RC17S

**Hitachi** A5000, MJS170

**Mats/Pan** H12A1AH4DX, N1301AB4,  
N1301AD4, N1301AE4, NL1300AA4,  
NL1300AE4, SA1150AE4

**Mitsubishi** FX105V, FX80,  
MSC130CVSG, MSC130CVSG2, MSC90,  
MSC90C

**Nihon** DKV14C

**Sanden** SD709CA, TR70, TRF090,  
TRS090

**Seiko-Seiki** SS10LV6, SS10V1, SS10V6,  
SS121DN1, SS121DN2, SS121DV2,  
SS96D1, SS96D2

**Visteon** HS090L, HS090R, HS110R,  
HS15, HS17, HS18

## Shipping Closures

### C95-3005

Plug

Size 5



**Denso** 10S11C, 10S11P, 10S13C,  
10S13P, 10S15C, 10S15L, 10S17C,  
10S20C, 10S20F, 10S20H, 10SR15C,  
10SR17C, 5SE09C, 5SE12C, 5SL12CJ,  
6SEU12C, 6SEU14C, 6SEU16, SC08  
(ITALY), SC08C (USA), SCS06C,  
SCSA06, SCSC06

**Diesel Kiki** DKV14J

**Hitachi** SWP167

**Mats/Pan** S1150F3

**Sanden** SD7B10, TRSA09, TRSE07

**Seiko-Seiki** SS10LV6, SS10V1, SS10V6

### C95-3006

Plug

Size 6



**Calsonic** CSV613, CWV615, CWV617,  
CWV618, DKV14D, V5-15C, V5-15F, V5-  
15G

**Delphi** SP10

**Denso** SC08C (SPAIN), TV10  
Series, TV12C(R12), TV12C(R134),  
TV12EC(R12), TV14C, TV14EC

**Diesel Kiki** DCV14J, DKV11G, DKV14G

**Hitachi** A5000, MJS170, SWP167

**Mats/Pan** N1301AE4, NL1300AE4,  
S1150F3, SA1150AE4

**Mitsubishi** FX105V, FX80,  
MSC130CVSG, MSC130CVSG2, MSC90,  
MSC90C

**Sanden** SD7C16, TR70, TRF090,  
TRS090

**Visteon** VS18M

**York** SC206, SC209

**Zexel** DCS17IC

## Tools

### LD22-121 Clutch and Coil Tools

Clutch Plate Remover



GM/Harrison DA6, HR6, HR6HE, HU6, V5, V5 (DESTROKER)

### LD22-292 Clutch and Coil Tools

Coil Installer



GM/Harrison DA6, HR6, HR6HE, HU6, V5, V5 (DESTROKER)

### LD99-1076 Clutch and Coil Tools

Clutch Pulley Removal Jaw



Sanden SD505

### LD99-1195 Clutch and Coil Tools

Clutch Plate Remover Arbor



GM/Harrison R4

### T11-1001 Clutch and Coil Tools

Clutch Puller



Chrysler A590, C171

Ford FS6, FS6 CROSS MOUNT

### T13-3041 Clutch and Coil Tools

Clutch Plate Installer



GM/Harrison A6, R4

### T13-3042 Clutch and Coil Tools

Clutch Plate Remover



Chrysler A590, C171

Ford FS6, FS6 CROSS MOUNT

GM/Harrison A6, R4

### T13-3046 Clutch and Coil Tools

Clutch Plate Remover



Calsonic V5-15C, V5-15F, V5-15G

Daewoo V5

GM/Harrison DA6, HD6, HR6, HR6HE, HT6, HU6, V5, V5 (DESTROKER)

### T13-3047 Clutch and Coil Tools

Clutch Plate Installer



Calsonic V5-15C, V5-15F, V5-15G

Daewoo V5

GM/Harrison DA6, HD6, HR6, HR6HE, HT6, HU6, V5, V5 (DESTROKER)

### T20-3004 Clutch and Coil Tools

Direct Drive Hub Remover



Denso 6SEU12, 6SEU16, 7SEU16

### T20-3006 Clutch and Coil Tools

Direct Drive Hub Remover



Denso 5SE12C

### T25-1000 Clutch and Coil Tools

Clutch Puller (3 Screw)



Diesel Kiki DKS13S, DKS15BH, DKS15CH, DKS15S, DKS17S

Nihon DKV14B, DKV14C

Sanden SD505, SD507, SD507A2, SD508, SD510, SD5H09, SD5H11, SD5H13, SD708, SD709, SD709CA, SD709CP, SD7H15

### T45-1001 Clutch and Coil Tools

Clutch Puller - Center Hub - Heavy Duty



Behr WINGCELL

Diesel Kiki DKS16H(R12), DKS16H(R134A)

Nihon DKV14B

### T65-1000 Clutch and Coil Tools

Clutch Puller (Heavy Duty)



Denso 10P13 Series, 10P15 Series, 10P17 Series

Hitachi A5000, MJ110, MJ123, MJ167, MJS130, MJS170, SWP123, SWP167

### T70-3001 Clutch and Coil Tools

Replacement Pusher Rod for T70-3000 - Short

### T70-3002 Clutch and Coil Tools

Replacement Pusher Rod for T70-3000 - Long

### T95-1015 Clutch and Coil Tools

GM Shaft Protector Pilot (Small)



### T95-1016 Clutch and Coil Tools

GM Shaft Protector Pilot (Large)



### T95-1072 Clutch and Coil Tools

Universal Clutch Holder Wrench



### T95-1073 Clutch and Coil Tools

Denso Clutch Hub Remover



### T95-1117 Clutch and Coil Tools

GM DA6/H6/LTR4/V5 Coil Installer



### T95-1153 Clutch and Coil Tools

GM Metric Compressor Clutch Plate Install/Remover



### T95-1212 Clutch and Coil Tools

Compressor Clutch Plate Install/Remover



### T95-1233 Clutch and Coil Tools

Clutch Hub Remover



Chrysler 6C17

### LD99-1170 Hand Tools

Retaining Ring Remover



GM/Harrison A6

### LD99-460 Hand Tools

O-Ring Installation Tool



GM/Harrison A6, R4

### T45-1000 Hand Tools

Spanner Nut Tool



Behr WINGCELL

Nihon DKV14B



## Tools

### T95-1070

#### Hand Tools

Internal Snap Ring Pliers



### T95-1071

#### Hand Tools

External Snap Ring Pliers



### T95-1167

#### Hand Tools

Mini Snap Ring Plier Set



### T95-1404

#### Hand Tools

Thread Chasers



### T95-1405

#### Hand Tools

Thread Chasers



Kit Contains:

Thread Chaser Set - Metric - 8 Sizes

M14-1.5P

M16-1.5P

M18-1.5P

M20-1.5P

M22-1.5P

M24-1.5P

M27-2P

M28-1.5P

Tee Bar -.8mm x 81mm

Repairs Inside and Outside Threads

### T10-6053

#### Helicoil Tools

Helical Insert Drill for 5/16-18 and 8-1.25mm Inserts



**Calsonic** CR14, CWV615, CWV617, CWV618, DKV14D, V5-15C, V5-15F, V5-15G

**Chrysler** 6C17, A590, C171

**Delphi** CVC-125, CVC-135, CVC-135E, CVC-165, CVC-185, CVC6, CVC7P, SP10, SP15

**Denso** 10P08E, 10P13 Series, 10P15 Series, 10P17 Series, 10PA15A, 10PA15C, 10PA15E, 10PA15L, 10PA15LC, 10PA15SC, 10PA17A, 10PA17C, 10PA17E, 10PA17H, 10PA17J, 10PA17K, 10PA20, 10PA20C, 10PA20H, 10PA20J, 5SL12CJ, 6CA17C, 6E171, 6E171A, 6P

**Diesel Kiki** DCV11A, DCV14A, DCV14J, DKS16H(R12), DKS16H(R134A), DKV11A, DKV11G, DKV14G

**Ford** FS10, FS18, FS6, FS6 CROSS MOUNT, FX15

**Hitachi** A5000, MJ110, MJ167, MJS130, MJS170, SWP167

**Keihin** 150L

**Mats/Pan** H12A1AH4DX, N1300AC4, N1301AB4, N1301AD4, N1301AE4, NL1300AA4, NL1300AB4, NL1300AE4, SA1150AE4

**Mitsubishi** AX105VSR, FX105V, FX80, FXA105VS, FXA105VSLR, FXA105VSR, FXA105VSSS, MSC105CVS, MSC130CVSG, MSC130CVSG2, MSC90, MSC90C

**Nihon** DKV14C, NVR140S

**Sanden** PXE13, PXE16, PXV16, SD5H09, SD709CA, SD709CP, SD7C16, SD7H15, SD7V16, TR090, TR70, TRF090, TRS090

**Seiko-Seiki** SS10LV6, SS10V1, SS10V6, SS121DN1, SS121DN2, SS121DV2, SS96D1, SS96D2

**Visteon** HS090L, HS090R, HS110R, HS15, HS17, HS18

**Zexel** DCS17E

### T10-6254

#### Helicoil Tools

Helical Insert Tap 8 - 1.25mm



**Calsonic** CR14, CWV615, CWV617, CWV618, DKV14D, V5-15C, V5-15F, V5-15G

**Chrysler** 6C17, A590, C171

**Delphi** CVC-125, CVC-135, CVC-135E, CVC-165, CVC-185, CVC6, CVC7P, SP10, SP15

**Denso** 10P08E, 10P13 Series, 10P15 Series, 10P17 Series, 10PA15A, 10PA15C, 10PA15E, 10PA15L, 10PA15LC, 10PA15SC, 10PA17A, 10PA17C, 10PA17E, 10PA17H, 10PA17J, 10PA17K, 10PA20, 10PA20C, 10PA20H, 10PA20J, 5SL12CJ, 6CA17C, 6E171, 6E171A, 6P

**Diesel Kiki** DCV11A, DCV14A, DCV14J, DKS16H(R12), DKS16H(R134A), DKV11A, DKV11G, DKV14G

**Ford** FS10, FS18, FS6, FS6 CROSS MOUNT, FX15

**Hitachi** A5000, MJ110, MJ167, MJS130, MJS170, SWP167

**Keihin** 150L

**Mats/Pan** H12A1AH4DX, N1300AC4, N1301AB4, N1301AD4, N1301AE4, NL1300AA4, NL1300AB4, NL1300AE4, S1150AE4, SA1150AE4

**Mitsubishi** AX105VSR, FX105V, FX80, FXA105VS, FXA105VSLR, FXA105VSR, FXA105VSSS, MSC105CVS, MSC130CVSG, MSC130CVSG2, MSC90, MSC90C

**Nihon** DKV14C, NVR140S

**Sanden** PXE13, PXE16, PXV16, SD5H09, SD709CA, SD709CP, SD7C16, SD7H15, SD7V16, TR090, TR70, TRF090, TRS090

**Seiko-Seiki** SS10LV6, SS10V1, SS10V6, SS121DN1, SS121DN2, SS121DV2, SS96D1, SS96D2

**Visteon** HS090L, HS090R, HS110R, HS15, HS17, HS18

**Zexel** DCS17E

### T10-6257

#### Helicoil Tools

Helical Insert Tap 10 - 1.5mm



### T10-6554

#### Helicoil Tools

Helical Insert Tool 8-1.25mm - Bolt Style



**Calsonic** CR14, CWV615, CWV617, CWV618, DKV14D, V5-15C, V5-15F, V5-15G

**Chrysler** 6C17, A590, C171

**Delphi** CVC-125, CVC-135, CVC-135E, CVC-165, CVC-185, CVC6, CVC7P, SP10, SP15

**Denso** 10P08E, 10P13 Series, 10P15 Series, 10P17 Series, 10PA15A, 10PA15C, 10PA15E, 10PA15L, 10PA15LC, 10PA15SC, 10PA17A, 10PA17C, 10PA17E, 10PA17H, 10PA17J, 10PA17K, 10PA20, 10PA20C, 10PA20H, 10PA20J, 5SL12CJ, 6CA17C, 6E171, 6E171A, 6P

**Diesel Kiki** DCV11A, DCV14A, DCV14J, DKS16H(R12), DKS16H(R134A), DKV11A, DKV11G, DKV14G

**Ford** FS10, FS18, FS6, FS6 CROSS MOUNT, FX15

**Hitachi** A5000, MJ110, MJ167, MJS130, MJS170, SWP167

**Keihin** 150L

**Mats/Pan** H12A1AH4DX, N1300AC4, N1301AB4, N1301AD4, N1301AE4, NL1300AA4, NL1300AB4, NL1300AE4, S1150AE4, SA1150AE4

## Tools

**Mitsubishi** AX105VSR, FX105V, FX80, FXA105VS, FXA105VSLR, FXA105VSR, FXA105VSSS, MSC105CVS, MSC130CVSG, MSC130CVSG2, MSC90, MSC90C

**Nihon** DKV14C, NVR140S

**Sanden** PXE13, PXE16, PXV16, SD5H09, SD709CA, SD709CP, SD7C16, SD7H15, SD7V16, TR090, TRF090, TRS090

**Seiko-Seiki** SS10LV6, SS10V1, SS10V6, SS121DN1, SS121DN2, SS121DV2, SS96D1, SS96D2

**Visteon** HS090L, HS090R, HS110R, HS15, HS17, HS18

**Zexel** DCS17E

### T10-6555 Helicoil Tools

Helical Insert Tool 10-1.5mm - Bolt Style



### T12-3000 Piston Tools

Piston Ring Expansion Cone (Requires T13-3010)



**Ford** FS10, FX15

**Visteon** HS15, HS17, HS18

### T13-3009 Piston Tools

10 Cubic Inch - Requires T13-3010



**GM/Harrison R4**

### T13-3010 Piston Tools

Nylon - For use w/Piston Ring Expansion Cones



**Calsonic** V5-15C, V5-15F, V5-15G

**Daewoo** V5

**Ford** FS10, FX15

**GM/Harrison** DA6, HD6, HR6, HR6HE, HT6, HU6, R4, V5, V5 (DESTROKER)

**Keihin** 150L, 150R

**Sanden** SD708, SD709, SD709CA, SD709CP, SD7H13, SD7H15, SD7V16

**Visteon** HS15, HS17, HS18

### T13-3048 Piston Tools

Piston Ring Expansion Cone (Requires T13-3010)



**GM/Harrison** DA6, HD6, HR6, HR6HE, HT6, HU6

### T13-3050 Piston Tools

Piston Ring Sizing Tool (Heavy Duty)



**GM/Harrison** V5, V5 (DESTROKER)

### T13-3051 Piston Tools

Piston Ring Expansion Cone (Heavy Duty) (Requires T13-3010)



**Calsonic** V5-15C, V5-15F, V5-15G

**Daewoo** V5

**GM/Harrison** V5, V5 (DESTROKER)

### T13-3052 Piston Tools

Half Moon Drive Piston Installer / Remover (Heavy Duty)



**GM/Harrison** R4

### T25-3004 Piston Tools

Piston Ring Expansion Cone (Requires T13-3010)



**Sanden** SD708, SD709, SD709CA, SD709CP, SD7H13, SD7H15, SD7V16

### T60-3002 Piston Tools

Piston Ring Expansion Cone (Requires T13-3010)



**Keihin** 150L, 150R

### T11-1000 Shaft Seal Protectors

Shaft Seal Protector (Metal)



**Bosch** AXIAL

**Calsonic** CWV615, CWV617, CWV618, DKV14D

**Chrysler** 6C17, A590, C171

**Denso** 5SL12CJ, 6E171, 6E171A, 6P127A, 6P127B, 6P134, 7SB16C, 7SBU16C, 7SBU17C

**Diesel Kiki** DCV11A, DCV14A, DKS13G (DUAL), DKS13G (SINGLE), DKS13S, DKS15G, DKS17G (DUAL), DKS17G (SINGLE), DKS17S, DKV11A

**Ford** FS6, FS6 CROSS MOUNT

**Hitachi** MJ110, MJS130

**Mats/Pan** N1300AC4, NL1300AA4, NL1300AB4, NL1300AE4

**Nihon** DKV14C

**Tama** TM08HD

### T12-1002 Shaft Seal Protectors

Lip Seal Protector (21 Spline) (Plastic)



**Ford** FS10, FS18, FX15

**Visteon** HS15, HS17, HS18

### T12-1003 Shaft Seal Protectors

Lip Seal Protector (16 Spline) (Metal)



**Ford** FX15

**Sanden** TRF105

**Visteon** HS15, HS17, HS18

### T13-1034 Shaft Seal Protectors

Shaft Seal Protector



**GM/Harrison** HT6, HU6

### T13-1035 Shaft Seal Protectors

Shaft Seal Protector (Late) (Metal)



**Calsonic** V5-15C, V5-15F, V5-15G

**Daewoo** V5

**GM/Harrison** A6, DA6, HR6, HR6HE, HU6, R4, V5, V5 (DESTROKER), V7

### T13-1036 Shaft Seal Protectors

Shaft Seal Protector (Early)



**GM/Harrison** DA6, HR6, HR6HE, HU6

### T25-1036 Shaft Seal Protectors

Shaft Seal Protector



**Sanden** SD505

### T25-1037 Shaft Seal Protectors

Shaft Seal Protector



**Calsonic** CR14

**Delphi** SP10, SP15

**Denso** TV10CA

**Diesel Kiki** DKS15CH

**Sanden** SD507, SD507A2, SD508, SD510, SD5H09, SD5H11, SD5H13, SD708, SD709, SD709CA, SD709CP, SD7B10, SD7H13, SD7H15, SD7V16, TR090, TR105, TR105VS, TR70, TRF090, TRF105, TRS090, TRS105

### T30-1000 Shaft Seal Protectors

Shaft Seal Protector



**Behr** WINGCELL

**Nihon** DKV14B, NVR140S

### T45-1002 Shaft Seal Protectors

Shaft Seal Protector



**Denso** TV12 Series, TV14C, TV14EC

**Diesel Kiki** DKS16H(R12), DKS16H(R134A)

**Hitachi** A5000, MJ167, MJS170, SWP167

## Tools

### T95-1221 Shaft Seal Protectors

Adjustable Shaft Seal Protector



**Mitsubishi** AX105VSL, AX105VSR, FX105V, FX80, FXA105VS, FXA105VSLR, FXA105VSR, FXA105VSS, FXA105VSSS, MSC130CVSG, MSC130CVSG2

**Sanden** TR105, TR105VS, TR70, TRF105, TRS105

### T95-1224 Shaft Seal Protectors

Adjustable Shaft Seal Protector



**Mitsubishi** MSC105CVS

### T95-1225 Shaft Seal Protectors

Adjustable Shaft Seal Protector



**Ford** LARGE SCROLL, SCROLL  
**Keihin** 150L, 150R  
**Sanden** TR090, TRF090, TRS090  
**Visteon** HS090L, HS090R, HS110R

### T95-1226 Shaft Seal Protectors

Adjustable Shaft Seal Protector



**Calsonic** CSV613  
**Delphi** CVC-125, CVC-135, CVC-165, CVC-185, CVC6, CVC7P, SP10, SP15  
**Mats/Pan** N1300AC4, N1301A0AH4, N1301AB4, N1301AD4, N1301AE4, NL1300AA4, NL1300AB4, NL1300AE4, S1150AE4, S1150F3, S1150X3, SA1150AE4  
**Seiko-Seiki** SS121DN1, SS121DN2, SS121DV2, SS170PSS, SS96D1, SS96D2

### T95-1227 Shaft Seal Protectors

Adjustable Shaft Seal Protector



**Calsonic** CR14  
**Delphi** CVC-135E  
**Denso** 10PA15 Series, 10PA17A, 10PA17C, 10PA17E, 10PA17H, 10PA17J, 10PA17K, 10PA17VC, 10PA20, 10PA20C, 10PA20H, 10PA20J, 10PA20VC, 10S11C, 10S11P, 10S13C, 10S13P, 10S15C, 10S15L, 10S17C, 10S20C, 10S20F, 10S20H, 5SE09C, 5SE12C, 6CA17C, 7SB16C,  
**Ford** FS10, FS18, FX15  
**Hadsys** RC17D, RC17S

**Sanden** PXV16, SD505, SD507, SD507A2, SD508, SD510, SD5H09, SD5H11, SD5H13, SD6V12, SD708, SD709, SD709CA, SD709CP, SD7B10, SD7H13, SD7H15

**Visteon** HS15, HS17, HS18, VS16, VS18M

**Zexel** DCS17E

### T95-1228 Shaft Seal Protectors

Adjustable Shaft Seal Protector



**Calsonic** CWV615, CWV617, CWV618, DKV14D, V5-15C, V5-15F, V5-15G

**Chrysler** 6C17, A590, C171

**Daewoo** V5

**Denso** 10P08E, 10P13 Series, 10P15 Series, 10P17 Series, 5SL12CJ, 6E171, 6E171A, 6P Series, 6SEU12, 7SE16, 7SEU16, TV10 Series, TV12SC(R134)

**Diesel Kiki** DCV11A, DCV14A, DCW17B, DCW17D, DKS13CH, DKS13G (DUAL), DKS13G (SINGLE), DKS13S, DKS15BH, DKS15CH, DKS15G, DKS15S, DKS17CH, DKS17D, DKS17G (DUAL), DKS17G (SINGLE), DKS17S, DKV11A, DKV11G, DKV14G

**Ford** FS6

**GM/Harrison** A6, DA6, HD6, HR6, HR6HE, HT6, HU6, R4, V5, V5 (DESTROKER), V7, V7 (DESTROKER)

**Hitachi** MJ110, MJS130

**Mitsubishi** MSC90, MSC90C

**Nihon** DKV14C

**Tama** TM08HD

### T95-1229 Shaft Seal Protectors

Adjustable Shaft Seal Protector



**Denso** 6SEU12C, 6SEU14C, 6SEU16, SCS06C, SCSA06, SCSC06

**Keihin** 150L, 150R

**Sanden** SD7V16

**Seiko-Seiki** SS10LV6, SS10V1, SS10V6

### T95-1230 Shaft Seal Protectors

FX15/FS10 21 Spline Shaft Seal Protector



**Diesel Kiki** DKS16H(R12), DKS16H(R134A)

**Ford** FS10

**Hitachi** A5000, MJ123, MJ167, MJS170, SWP123, SWP167

**Sanden** PXE13, PXE16, SD7C16

### T95-1232 Shaft Seal Protectors

Adjustable Lip Seal Protectors Kit



### T95-1396 Shaft Seal Protectors

FX15/FS10 21 Spline Shaft Seal Protector



**Ford** FS10, FS18, FX15

### LD99-1326 Shaft Seal Tools

Shaft Seal Remover



**Ford** FX15

**Visteon** HS15, HS17, HS18

### T10-1000 Shaft Seal Tools

Seal/Plate Alignment Tool



**Chrysler** RV2

**Tecumseh** HG1000, HG500, HG850

**York** 206, 209, 210, SC206, SC209

### T13-1037 Shaft Seal Tools

Ceramic/Metal Shaft Seal Seat Remover/Installer



**GM/Harrison** A6, DA6, HR6, HR6HE, HU6, R4

### T20-3002 Shaft Seal Tools

Shaft Seal Installer / Remover (Aftermarket)



**Denso** 10P08E, 10P13 Series, 10P15 Series, 10P17 Series, 10PA15A, 10PA15C, 10PA15E, 10PA15L, 10PA15LC, 10PA15SC, 10PA15VC, 10PA17A, 10PA17C, 10PA17E, 10PA17H, 10PA17J, 10PA17K, 10PA17SC, 10PA17SH, 10PA17VC, 10PA17VSC, 10PA20C, 10PA20H, 10P

**Ford** FS6, FS6 CROSS MOUNT

### T25-1030 Shaft Seal Tools

Shaft Seal Installer / Remover



**Sanden** SD505, SD507, SD507A2, SD508, SD510, TR090, TR105, TR105VS, TR70, TRF090, TRF105, TRS090, TRS105

## Tools

### T25-3001 Shaft Seal Tools

Shaft Seal Install / Remover



**Sanden** SD708, SD709, SD709CA, SD709CP

### T50-3001 Shaft Seal Tools

Shaft Seal Install / Remover



**Mats/Pan** N1300AC4, N1301AB4, N1301AD4, N1301AE4, NL1300AA4, NL1300AB4, NL1300AE4, S1150F3, S1150X3, SA1150AE4

### T55-1033 Shaft Seal Tools

Shaft Seal Seat Remover



**Mitsubishi** AX105VSR, FX105V, FX80, FXA105VS, FXA105VSLR, FXA105VSR, FXA105VSSS, MSC130CVSG, MSC130CVSG2

### T60-3001 Shaft Seal Tools

Shaft Seal Seat Installer / Remover (O.E.)



**Daewoo** V5  
**Denso** 10P08E, 10P13 Series, 10P15 Series, 10P17 Series, 10PA15A, 10PA15C, 10PA15E, 10PA15L, 10PA15LC, 10PA15SC, 10PA15VC, 10PA17A, 10PA17C, 10PA17E, 10PA17H, 10PA17J, 10PA17K, 10PA17SC, 10PA17SH, 10PA17VC, 10PA17VSC, 10PA20C, 10PA20H, 10P  
**GM/Harrison** DA6, HD6, HR6, HR6HE, HT6, HU6, R4, V5, V5 (DESTROKER)  
**Keihin** 150L, 150R

### T12-1006 Spring Lock Tools

7/16" Brass Brush for 3/8" #6 Spring Lock Fitting



### T12-1008 Spring Lock Tools

9/16" Brass Brush for 1/2" #8 Spring Lock Fitting



### T12-1010 Spring Lock Tools

11/16" Brass Brush for 5/8" #10 Spring Lock Fitting



### T12-1012 Spring Lock Tools

7/8" Brass Brush for 3/4" #12 Spring Lock Fitting



### T95-1400 Test Equipment

Control Valve Testing Unit



Testing Unit includes:  
 Hand Held Unit for Operation Control Power Lead for 12v Battery Supply Direct Connector for VAG Group Compressors Direct Connector for Denso Compressors Simulation Electronic Box (to bypass system while control valve is discon

### T95-8008-1A Test Equipment

Control Valve Test Machine

### T95-8121 Test Equipment

Compressor Test Machine

### T10-2151 Valve Core Tools

R12 Service Port Thread Repair Tool



### T95-1146 Valve Core Tools

Valve Core Installation/Removal Tool



### T13-1038 Set - Clutch Inst/Rem

Clutch Installer & Remover Kit-Chrysl, DKS, Ford, GM, Sanden



Kit Contains:  
 (1) 3 Eye Round Sanden, DKS, Zexel Clutch Plate Arbor  
 (1) Drive Arbor Bolt Sanden  
 (1) Drive Arbor Bolt DKS, Zexel  
 (3) Retaining Bolts 7/16"-20"  
 (1) GM Standard Clutch Plate Arbor  
 (1) GM Metric Clutch Plate Arbor  
 (1) Denso Standard / Me

### T95-1154 Set - Clutch Inst/Rem

Clutch Plate Remover - DKS, Mitsubishi, Sanden, Zexel



Kit Contains:  
 (1) 3 Eye Round Sanden, DKS, Zexel Clutch Plate Arbor  
 (1) Drive Arbor Bolt  
 (3) 1/4"-20" Bolts  
 (3) 8mm-1.0 Bolts  
 (2) 10mm-1.5 Bolts

### T95-1158 Set - Clutch Inst/Rem

Clutch Tool Set - GM, Ford, Chry, Denso, Sanden



Kit Contains:  
 (1) 3 Eye Round Arbor  
 (1) Sanden Arbor Drive Bolt  
 (1) Diesel Kiki, Zexel Arbor Drive Bolt  
 (1) Denso - Standard / Metric Arbor  
 (1) Denso - Remover Arbor  
 (1) Denso - Installer Arbor  
 (1) GM Standard Clutch Plate Remover Arbor  
 (1) GM S

### T95-1159 Set - Clutch Inst/Rem

Clutch Tool Set - GM, Ford, Chry, Denso, Sanden



Kit Contains:  
 (1) Universal Clutch Spanner Wrench  
 (1) Denso Standard / Metric Clutch Plate Arbor  
 (1) Denso Arbor Drive Bolt  
 (1) (3) Eye Sanden, DKS, Zexel Clutch Plate Arbor  
 (1) Sanden Arbor Drive Bolt  
 (1) DKS, Zexel Arbor Drive Bolt  
 (1) GM Standar

## Tools

### T95-1164 Set - Clutch Inst/Rem

Universal Multi Purpose Puller and Arbor Set



Kit Contains:

- (1) Multi Position Steel Cast Arbor
- (1) Arbor Drive Bolt
- (2) 5" Puller Jaws
- (2) 3" Puller Jaws
- (1) Cross Draw Stabilizer York

### T95-1165 Set - Clutch Inst/Rem

Clutch Rotor Puller Tool Set - GM R4



Kit Contains:

- (1) Adjustable Aluminum Arbor
- (1) Drive Arbor Bolt
- (2) Puller Jaws
- (1) Shaft Protector (.126 Deep)
- (1) Shaft Protector (.25 Deep)

### T95-1166 Set - Clutch Inst/Rem

Clutch Pulley Puller Tool Set - GM R4, H6 Series, V5



Kit Contains:

- (1) Adjustable Aluminum Arbor
- (1) Arbor Drive Bolt
- (2) Wide Pulley Puller Jaws
- (1) Shaft Protector

### T95-1403 Set - Clutch Inst/Rem

Clutch Tool Set - GM, Chrys, Denso, DKS, Ford, Sanden, Zexel

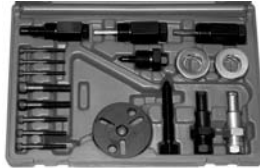

Kit Contains:

- (1) GM Standard Thread Hub Remover/Installer
- (1) GM Metric Thread Hub Remover/Installer
- (1) Denso Coarse Thread Hub Remover
- (1) Denso Fine Thread Hub Remover
- (1) DKS Hub Puller
- (1) Zexel Hub Puller
- (1) DKS/Sanden 3 Eye Hub Puller

### K10-1180 Set - Helicoil Instal

Helical Insert Repair Kit (8-1.25mm)



Includes: Helical Inserts (25), Drill (1), Tap (1), Installation Tool - Bolt Style (1)

**Calsonic** CR14, CWV615, CWV617, CWV618, DKV14D, V5-15C, V5-15F, V5-15G

**Chrysler** 6C17, A590, C171

**Delphi** CVC-125, CVC-135, CVC6, SP10, SP15

**Denso** 10P08E, 10P13 Series, 10P15 Series, 10P17 Series, 10PA15A, 10PA15C, 10PA15E, 10PA15L, 10PA15LC, 10PA15SC, 10PA17A, 10PA17C, 10PA17E, 10PA17H, 10PA17J, 10PA17K, 10PA17SC, 10PA17SH, 10PA17VSC, 10PA20C, 10PA20H, 10PA20J, 10PA20SC, 10PA

**Diesel Kiki** DCV11A, DCV14A, DCV14J, DKS16H(R12), DKS16H(R134A), DKV11A, DKV11G, DKV14G, DKV14J

**Ford** FS10, FS18, FS6, FS6 CROSS MOUNT, FX15

**Hitachi** A5000, MJ110, MJ167, MJS130, MJS170, SWP167

**Keihin** 150R

**Mats/Pan** H12A1AH4DX, N1300AC4, N1301AB4, N1301AD4, N1301AE4, NL1300AA4, NL1300AB4, NL1300AE4, S1150AE4, SA1150AE4

**Mitsubishi** FX105V, MSC130CVSG, MSC130CVSG2

**Nihon** DKV14C, NVR140S

**Sanden** PXE13, PXE16, PXV16, SD5H09, SD709CP, SD7H15, SD7V16, TR090, TRF090, TRS090

**Seiko-Seiki** SS10LV6, SS10V1, SS10V6, SS121DN1, SS121DN2, SS121DV2, SS96D1, SS96D2

**Visteon** HS090L, HS090R, HS110R

**Zexel** DCS17E

### T95-1162 Set - Shaft Seal

Master Shaft Seal Service Tool Set

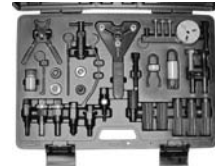

Kit Service these Compressor Groups

GM: A6, Std R4, Lt R4, DA6 Carbon, HR6 and V5

Ford: FS6

Chrysler: A590, C171, 6C17, RV2

Denso: 6P and 10P Series

Sanden: SD507, SD508, SD510

York: 206,209,210

Techumseh: HG500, HG1000

### T95-1168 Set - Shaft Seal

Set - Seal Seat Remover & Installers



Kit Contains:

- (4) Individual Tools
- (1) Sanden SD505, SD507 Mini Series
- (1) Sanden SD507, SD508, SD510 Series
- (1) Sanden SD708, SD709 Series
- (1) Denso 10P Series

### T95-1169 Set - Shaft Seal

Shaft Seal Tool Kit - Denso 10PA Series



Kit Contains:

- (1) Shaft Seal Remover
- (1) Shaft Seal Installer
- (1) Shaft Seal Protector
- (1) Internal Snap Ring Remover

## Tools

### T95-1170 Set - Shaft Seal

Shaft Seal Tool Kit - Diesel Kiki



Kit Contains:

- (1) Drive Plate Installer
- (1) Drive Plate Remover
- (1) Snap Ring Installer
- (1) Pulley Puller Pilot
- (1) Shaft Seal Remover/Installer
- (1) Shaft Seal Seat Remover/Installer

### T95-1174 Set - Shaft Seal

Shaft Seal Tool Kit - GM DA6 with Carbon Seal



Kit Contains:

- (1) Shaft Seal Remover/Installer
- (1) Shaft Seal Protector
- (1) Clutch Plate Remover (Metric)
- (1) Clutch Plate Installer (Metric)
- (1) O-Ring & Snap Ring Installer
- (1) O-Ring Installer Guide

### T95-1171 Set - Shaft Seal

Shaft Seal Tool Kit - Ford FS6, Chry C171, A590, 6P, 10P



Kit Contains:

- (1) Clutch Plate Installer
- (1) Clutch Plate Remover
- (1) Seal Seat Remover
- (1) O-Ring Installer Guide

### T95-1175 Set - Shaft Seal

Shaft Seal Tool Kit - Hitachi, Mitsubishi



Kit Contains:

- (1) Nut Remover/Installer
- (1) Shaft Seal Remover Lock Nut
- (1) Shaft Seal Remover - Mitsubishi
- (1) Bearing & Pulley Installer - Mitsubishi
- (1) Shaft Seal Remover/Installer - Mitsubishi
- (1) Spanner Plug Remover/Installer - Hitachi

### T95-1172 Set - Shaft Seal

Shaft Seal Tool Kit - Ford FX15 / FS10



Kit Contains:

- Shaft Seal Protector 16 Spline
- Shaft Seal Protector 21 Spline
- 16 Spline - 0.489 I.D.
- 21 Spline - 0.513 I.D.

### T95-1177 Set - Shaft Seal

Shaft Seal Tool Kit - Sanden SD507 / 508 / 510



Kit Contains:

- (1) Clutch Plate Puller
- (1) Shaft Seal Remover/Installer
- (1) Shaft Seal Protector
- (1) Clutch Plate Installer



## BEHR WINGCELL

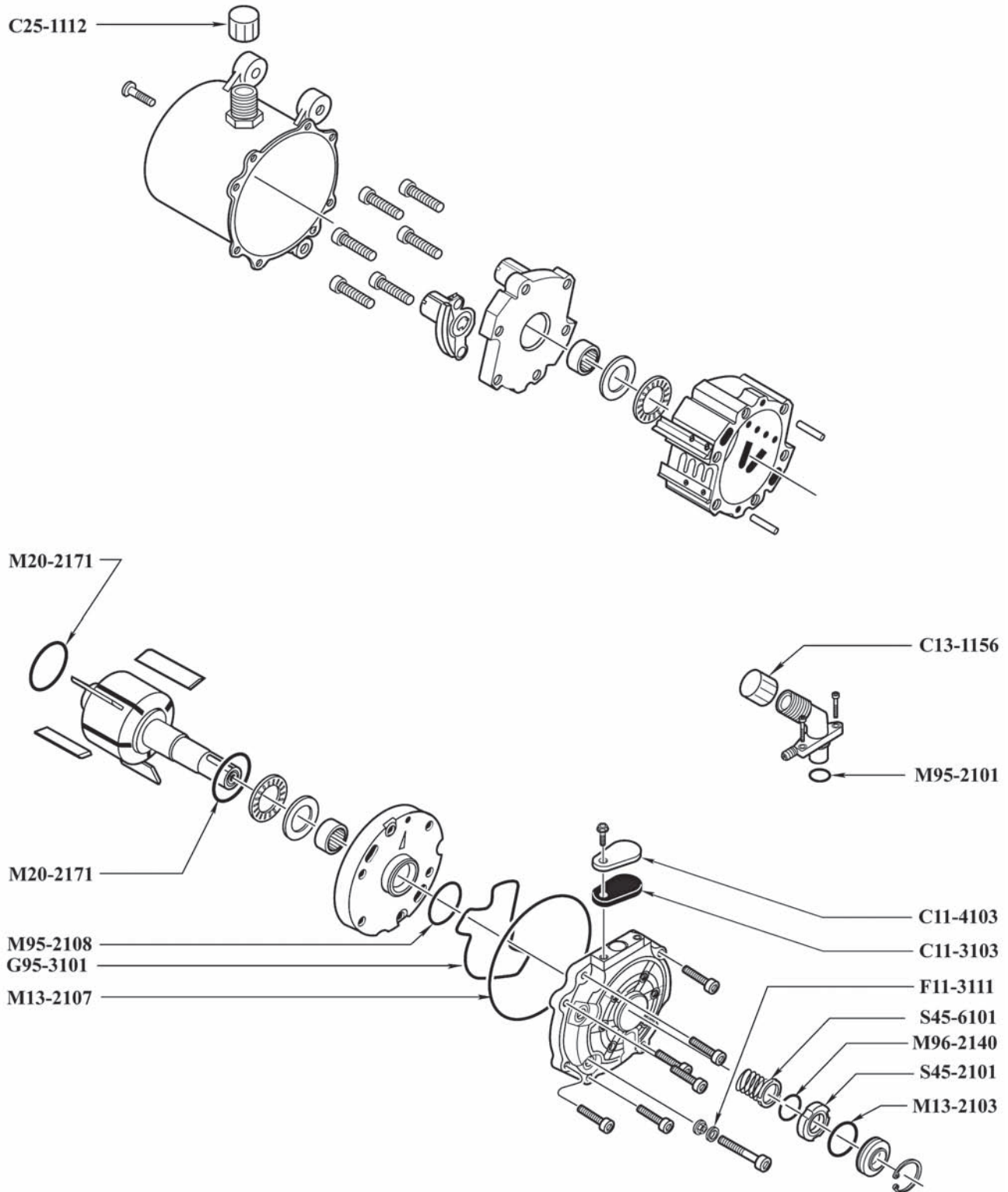



## BEHR WINGCELL

O-Rings	R134a and R-12 Compatible	Green HNBR	Black Nitrile
Carbon Shaft Seal O-Ring		<b>M96-2140</b>	<b>M96-1040</b>
Case O-Ring		<b>M13-2107</b>	<b>M13-1007</b>
Internal Head O-Ring		<b>M95-2108</b>	<b>M95-1008</b>
Rotor O-Ring		<b>M20-2171</b>	<b>M20-1071</b>
Shaft Seal Seat O-Ring		<b>M13-2103</b>	<b>M13-1003</b>
Suction Port O-Ring		<b>M95-2101</b>	<b>M95-1001</b>

### Bearings

Clutch Bearing (30mm x 55mm x 23mm) **B12-1120**

### Chemicals

Ultra PAG Oil 100 - 6pk, 8 oz Bottle **MT3013**

Ultra PAG Oil 100 - 6pk, Quart Bottle **MT3019**

Ultra PAG Oil 100 - Drum (52 gal) **A10-6164**

### Fasteners

Adapter - Oil Plug Switch Port **F95-8000**

Washer - Head Bolt **F11-3111**

### Gaskets

Gasket - Rotor Body Green HNBR **G95-3101**

Gasket Kit Green HNBR **K95-2101**

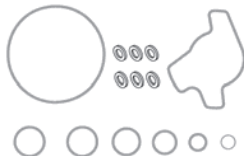

*Includes: Head Bolt Washer (6), Rotor Body Gasket (1), Metal Shaft Seal Seat O-Ring (1), Case O-Ring (1), Rotor O-Ring (2), Internal Head O-Ring (1), Carbon Shaft Seal O-Ring (1), Suction Port O-Ring (1).*

Gasket Kit Black Nitrile **K95-2001**

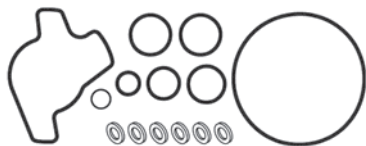

*Includes: Head Bolt Washer (6), Rotor Body Gasket (1), Metal Shaft Seal Seat O-Ring (1), Case O-Ring (1), Rotor O-Ring (2), Internal Head O-Ring (1), Carbon Shaft Seal O-Ring (1), Suction Port O-Ring (1).*

### Gaskets

Rebuilder Kit Black Nitrile **K95-6001**



*Includes: Shipping Pad (1), Shipping Plate(1), Suction Cap(1), Discharge Cap(Flare)(1), Head Bolt Washer(6), Rotor Body Gasket(1), Metal Shaft Seal Seat O-Ring(1), Case O-Ring(1), Rotor O-Ring(2), Internal Head O-Ring(1), Carbon Shaft Seal O-Ring(1).*

### Shaft Seals

Carbon Shaft Seal Ring HNBR **S45-2101**

Shaft Seal Spring **S45-6101**

Carbon Shaft Seal Kit Green HNBR **K45-3105**



*Includes: Carbon Ring (1), Shaft Seal Spring(1), Carbon Shaft Seal O-Ring (1), Metal Shaft Seal Seat O-Ring (1)*

### Shipping Closures

Discharge Cap w/ O-Ring - 4/5" (.800") Height **C25-1112**

Plug - Switch Port (Steel Braze On) **C95-2000**

Shipping Cap - Suction Port **C13-1156**

Shipping Pad (Use with C11-4103) **C11-3103**

Shipping Plate (Use with C11-3103) **C11-4103**

### Tools

Clutch Puller - Center Hub **T45-1001**

Shaft Seal Protector **T30-1000**

Spanner Nut Tool **T45-1000**

## BOSCH AXIAL

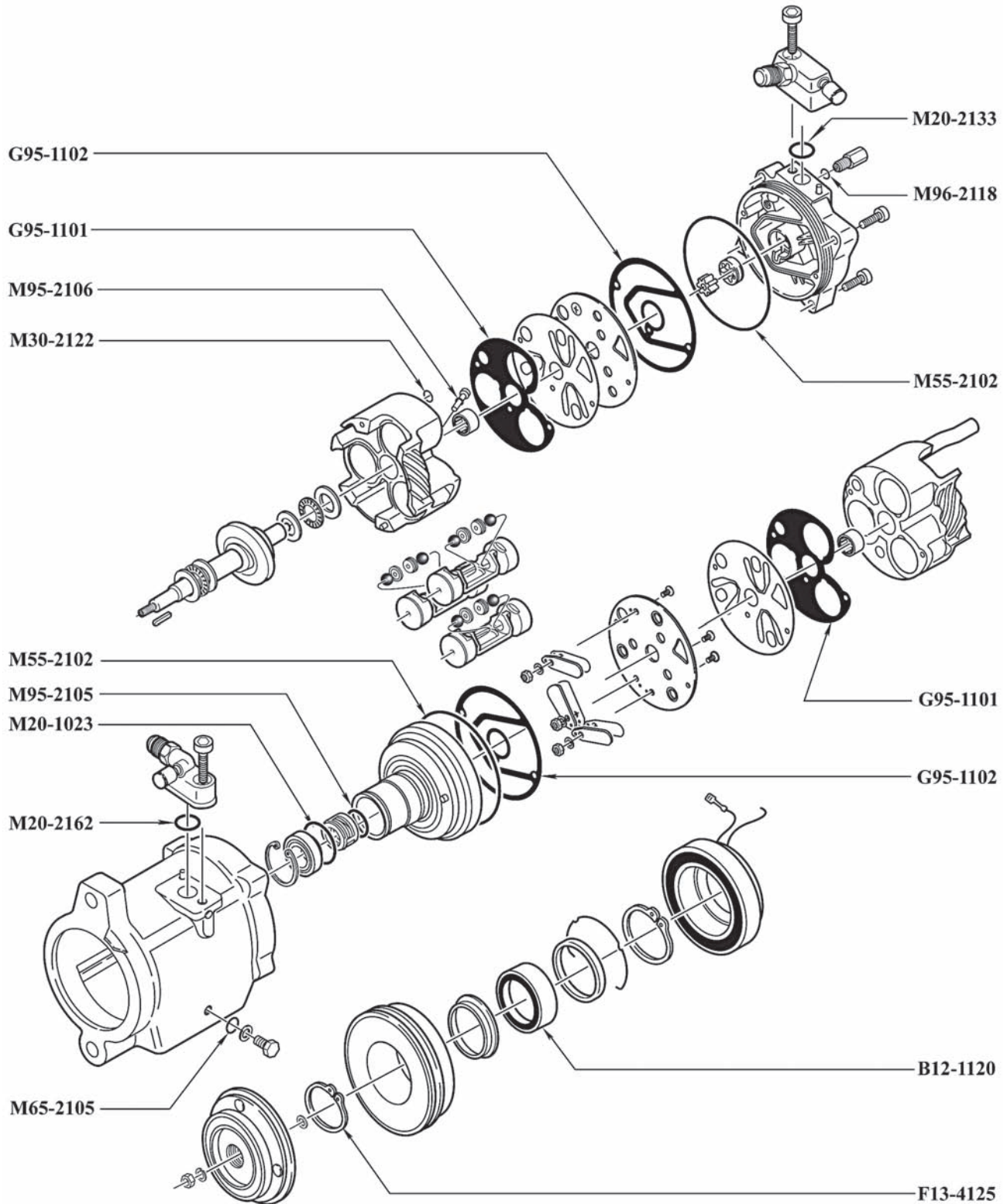

## BOSCH

### AXIAL

O-Rings	R134a and R-12 Compatible	Green HNBR	Black Nitrile
Carbon Shaft Seal O-Ring		M95-2105	M95-1005
Case O-Ring		M55-2102	
Crossover O-Ring		M30-2122	
Discharge Manifold O-Ring		M20-2133	
High Pressure Relief Valve O-Ring		M96-2118	M96-1018
Oil Drain Plug O-Ring		M65-2105	M65-1005
Oil Pickup Tube O-Ring		M95-2106	M95-1006
Shaft Seal Seat O-Ring			M20-1023
Suction Manifold O-Ring		M20-2162	
<b>Bearings</b>			
Clutch Bearing (30mm x 55mm x 23mm)	B12-1120		
<b>Chemicals</b>			
Ultra PAG Oil 46 - 6pk, 8 oz Bottle	MT3012		
Ultra PAG Oil 46 - 6pk, Quart Bottle	MT3018		
Ultra PAG Oil 46 - Drum (52 gal)	A10-6163		
<b>Fasteners</b>			
Retaining Ring - Pulley (Beveled)	F13-4125		
<b>Gaskets</b>			
Gasket - Cylinder	Fiber	G95-1101	
Gasket - Head	Fiber	G95-1102	
Gasket Kit (Fiber)	Black Nitrile	K95-2005	



*Includes: Cylinder Gasket (2), Head Gasket (2), Metal Shaft Seal Seat O-Ring (1), Crossover O-Ring (1), Case O-Ring (2), Oil Plug O-Ring (1), Carbon Shaft Seal O-Ring (1), Oil Pickup Tube O-Ring (1)*

#### Shipping Closures

Suction Cap w/ Disc - 1" Height **C25-1113**

#### Tools

Shaft Seal Protector **T11-1000**

## CALSONIC

### CR14

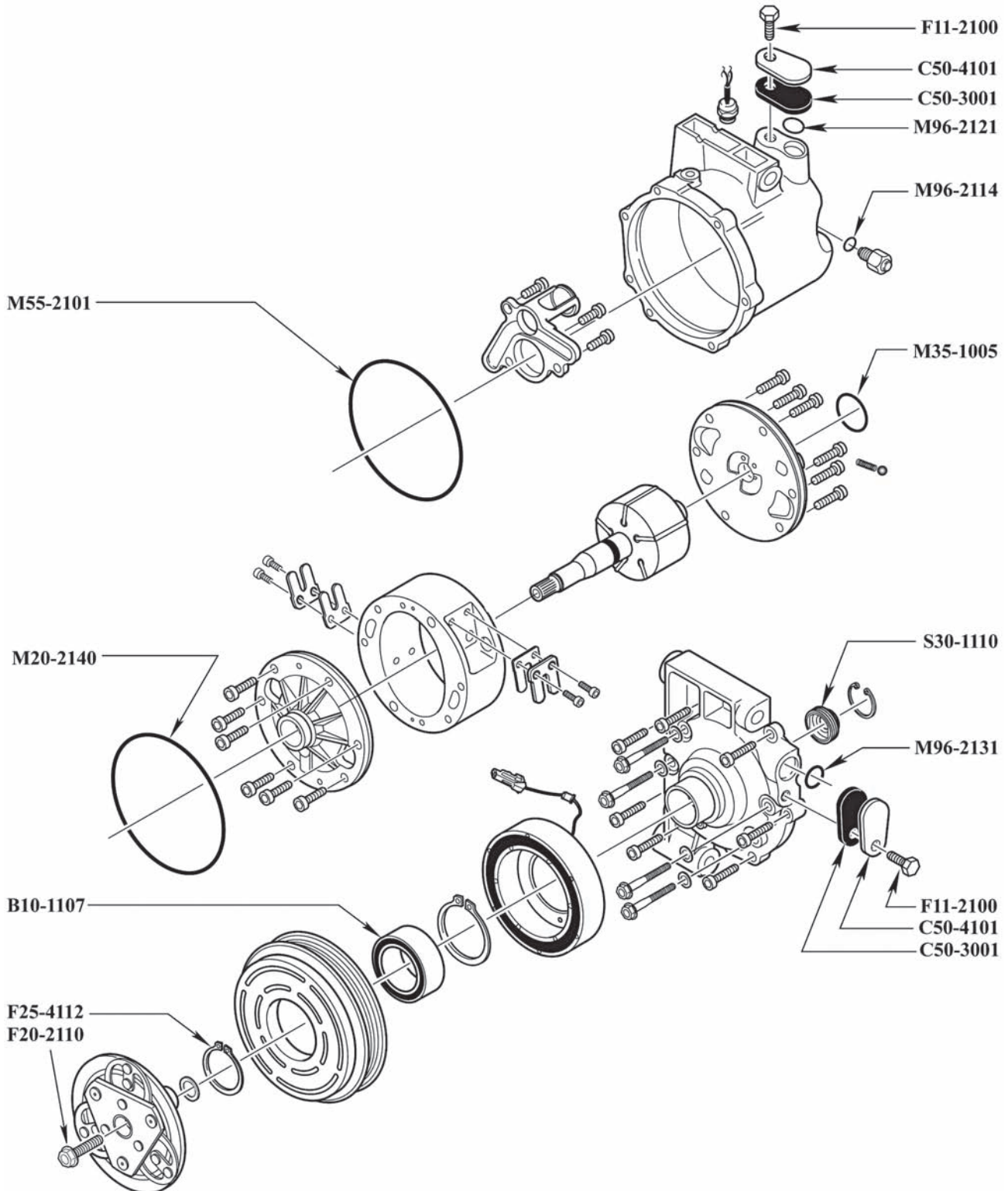

## CALSONIC

### CR14

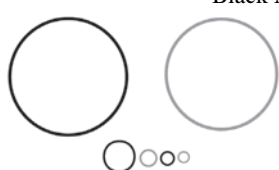
O-Rings	R134a and R-12 Compatible	Green HNBR	Black Nitrile
Case O-Ring (Front)		<b>M20-2140</b>	<b>M20-1040</b>
Case O-Ring (Rear)		<b>M55-2101</b>	
Discharge Port O-Ring		<b>M96-2121</b>	<b>M96-1021</b>
Pressure Relief Valve O-Ring		<b>M96-2114</b>	
Rear Discharge Plate O-Ring			<b>M35-1005</b>
Suction Port O-Ring		<b>M96-2131</b>	
Bearings		Tools	
Clutch Bearing (35mm x 55mm x 20mm)	<b>B10-1107</b>	Shaft Seal Protector	<b>T25-1037</b>
Chemicals		Shaft Seal Protector, Adjustable	<b>T95-1227</b>
Ultra PAG Oil 100 - 6pk, 8 oz Bottle	<b>MT3013</b>	Helical Insert Repair Kit (8-1.25mm)	<b>K10-1180</b>
Ultra PAG Oil 100 - 6pk, Quart Bottle	<b>MT3019</b>		
Ultra PAG Oil 100 - Drum (52 gal)	<b>A10-6164</b>		
Fasteners			
Bolt - Shaft	<b>F20-2110</b>		
Bolt - Shipping Plate	<b>F11-2100</b>		
Helical Insert - Rear Head / Shipping Plate (8-1.25 x 12mm)	<b>F10-6211</b>		
Retaining Ring - Clutch Pulley	<b>F25-4112</b>		
Gaskets			
Gasket Kit	Black Nitrile <b>K75-2003</b>		
			
<p><i>Includes: Front Case O-Ring (1), Rear Discharge Plate O-Ring (1), Rear Case O-Ring (1), Discharge Port O-Ring (1), Suction Port O-Ring (1), PRV O-Ring (1).</i></p>			
Shaft Seals			
Lip Seal (Black Rubber Coated)	HNBR <b>S30-1110</b>		
Shipping Closures			
Shipping Pad (Use with C50-4101)	<b>C50-3001</b>		
Shipping Plate (Use with C50-3001)	<b>C50-4101</b>		
Shipping Plate (Use with C95-3002 & C95-3004)	<b>C95-4001</b>		
Shipping Plug (Discharge) (Use with C95-4001)	<b>C95-3002</b>		
Shipping Plug (Suction) (Use with C95-4001)	<b>C95-3004</b>		
Tools			
Helical Insert Drill for 8-1.25mm Inserts	<b>T10-6053</b>		
Helical Insert Tap 8-1.25mm	<b>T10-6254</b>		
Helical Insert Tool 8-1.25mm - Bolt Style	<b>T10-6554</b>		



*Includes: Helical Inserts (25), Drill (1), Tap (1), Installation Tool - Bolt Style (1)*

## CALSONIC CSV613

CONTROL VALVE	
M96-2118	
M96-2141	
M96-2140	
A13-5132	
A75-5100	
F13-4115	

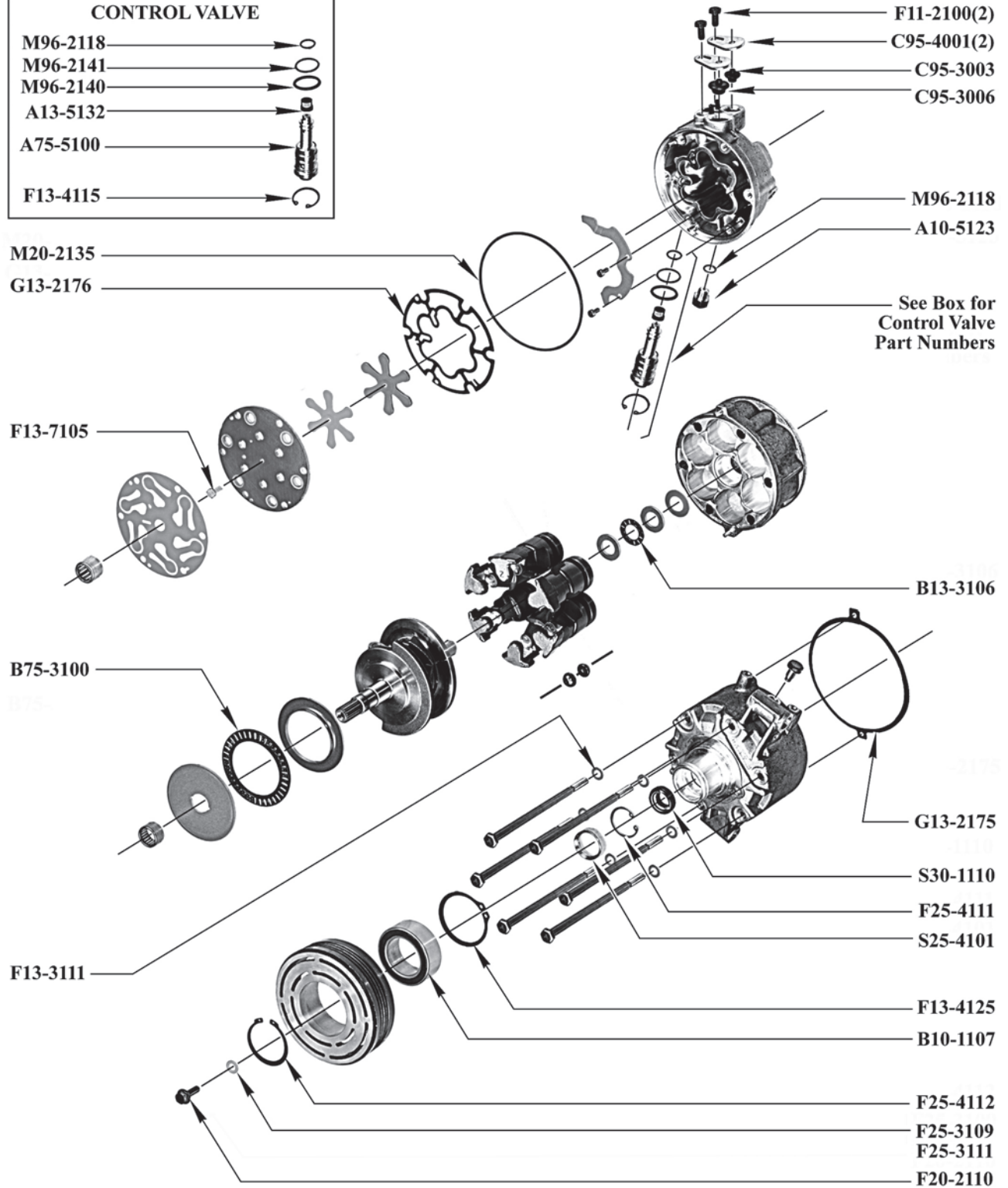

## CALSONIC

### CSV613

O-Rings	R134a and R-12 Compatible	Green HNBR	Black Nitrile
Case O-Ring		<b>M20-2135</b>	<b>M20-1035</b>
Control Valve Inner / High PSI Relief Valve O-Ring		<b>M96-2118</b>	<b>M96-1018</b>
Control Valve Middle O-Ring		<b>M96-2141</b>	<b>M96-1041</b>
Control Valve Outer O-Ring		<b>M96-2140</b>	<b>M96-1040</b>

Bearings	
Clutch Bearing (35mm x 55mm x 20mm)(Late)	<b>B10-1107</b>
Thrust Bearing (45mm x 65mm x 3mm)	<b>B75-3100</b>
Thrust Bearing (16mm x 35mm x 4.76mm)	<b>B13-3106</b>

Chemicals	
Ultra PAG Oil 150 - 6pk, 8 oz Bottle	<b>MT3014</b>
Ultra PAG Oil 150 - 6pk, Quart Bottle	<b>MT3020</b>
Ultra PAG Oil 150 - Drum (52 gal)	<b>A10-6165</b>

Control Valves	
Control Valve	<b>A75-5100</b>
Control Valve Screen	<b>A13-5132</b>
O-Ring Kit, Control Valve	Green HNBR <b>K13-2122</b>

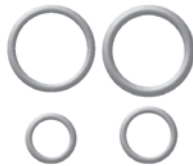

Includes: Control Valve O-Ring (Inside) (1), Control Valve O-Ring (Inside Center) (1), Control Valve O-Ring (Outside) (1), Control Valve O-Ring (Outside Center) (1)

Fasteners	
Bolt - Shaft	<b>F20-2110</b>
Bolt - Shipping Plate/Oil Drain Plug	<b>F11-2100</b>
Rivet - Valve Plate	<b>F13-7105</b>
Retaining Ring - Clutch Coil (Beveled)	<b>F13-4125</b>
Retaining Ring - Control Valve	<b>F13-4115</b>
Retaining Ring - Lip Seal	<b>F25-4111</b>
Retaining Ring - Pulley	<b>F25-4112</b>
Shim - Clutch (0.38mm)	<b>F25-3111</b>
Shim - Clutch (0.76mm)	<b>F25-3109</b>
Washer - Head Bolt	<b>F13-3111</b>

Gaskets	
Gasket - Front Head	Fiber <b>G13-1173</b>
Gasket - Rear Head	Fiber <b>G13-1174</b>
Gasket - Front Head	Metal <b>G13-2175</b>
Gasket - Rear Head	Metal <b>G13-2176</b>

Service Items	
High Pressure Relief Valve M10x1.25 W/O-ring Non Captive	<b>A10-5123</b>

Shaft Seals	
Felt Ring	<b>S25-4101</b>
Lip Seal (Black Rubber Coated)	HNBR <b>S30-1110</b>
Lip Seal Kit	Black Nitrile <b>K30-3008</b>



Includes: Lip Seal Retaining Ring (1), Felt Ring (1), Lip Seal (1)

Shipping Closures	
Shipping Plate (Use with C95-3003 & C95-3006)	<b>C95-4001</b>
Shipping Plug (Discharge) (Use with C95-4001)	<b>C95-3003</b>
Shipping Plug (Suction) (Use with C95-4001)	<b>C95-3006</b>

Tools	
Shaft Seal Protector, Adjustable	<b>T95-1226</b>

## CALSONIC

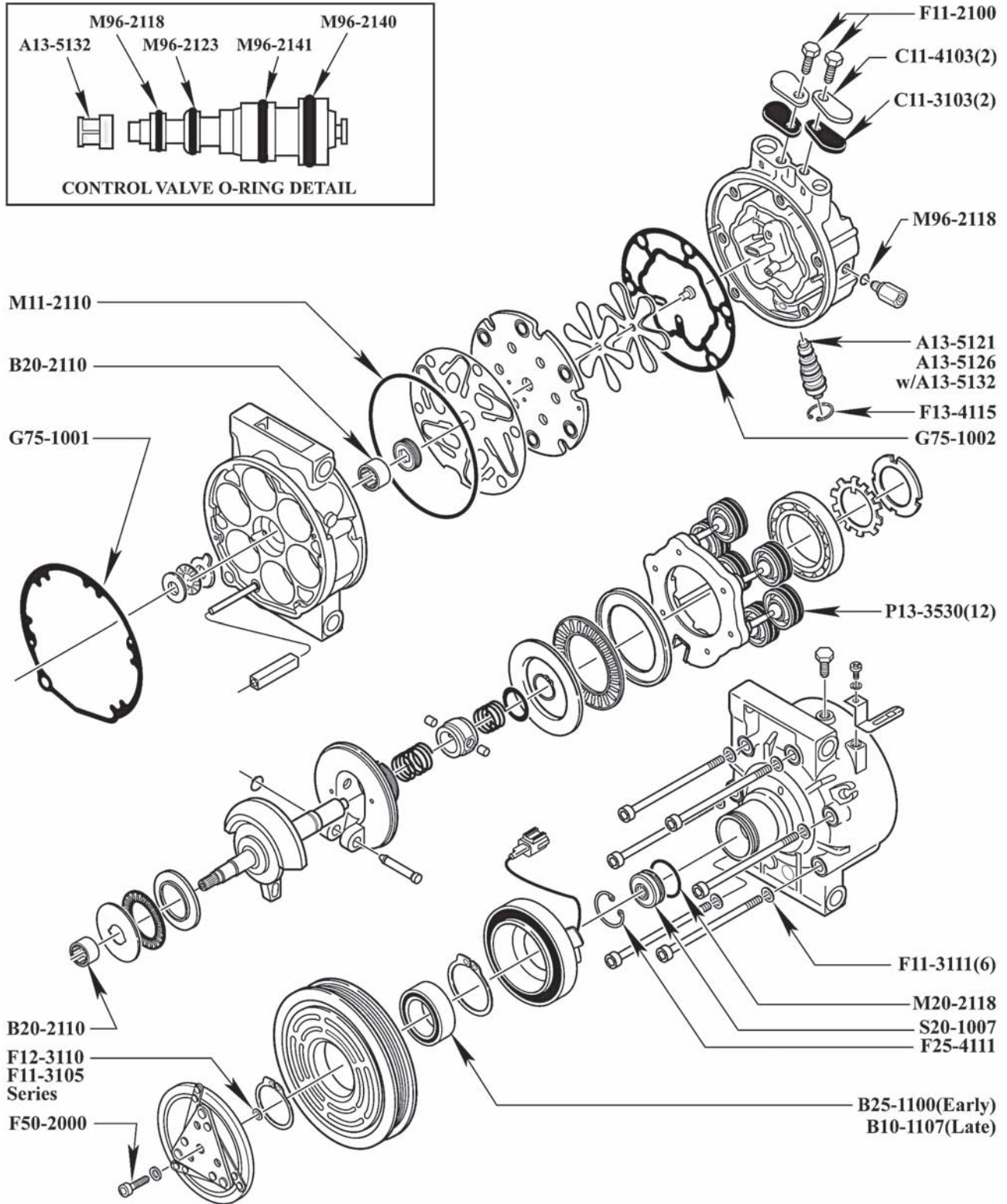
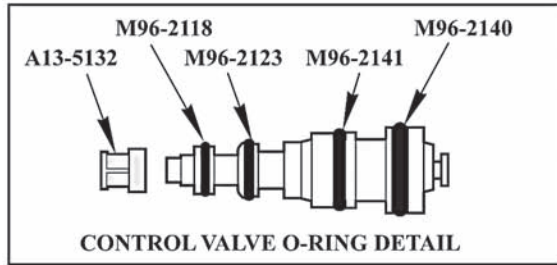

### CWV615, CWV617, CWV618



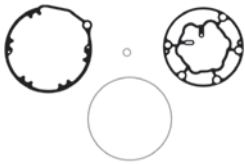

## CALSONIC

### CWV615, CWV617, CWV618

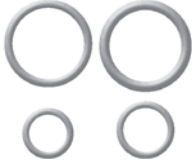
O-Rings	R134a and R-12 Compatible	Green HNBR	Black Nitrile
Case O-Ring		<b>M11-2110</b>	
Control Valve (Inner) / High PSI Relief Valve O-Ring		<b>M96-2118</b>	<b>M96-1018</b>
Control Valve O-Ring (Inside Center)		<b>M96-2123</b>	<b>M96-1023</b>
Control Valve O-Ring (Outside Center)		<b>M96-2141</b>	<b>M96-1041</b>
Control Valve O-Ring (Outside)		<b>M96-2140</b>	<b>M96-1040</b>
Lip Seal O-Ring		<b>M20-2118</b>	<b>M20-1018</b>
<b>Bearings</b>		<b>Fasteners</b>	
Case Bearing (16mm x 23mm x 16mm)	<b>B20-2110</b>	Shim - Clutch (0.51mm)	<b>F11-3115</b>
Clutch Bearing (35mm x 55mm x 20mm)(Late)	<b>B10-1107</b>	Washer - Head Bolt	<b>F11-3111</b>
Clutch Bearing (40mm x 62mm x 24mm)(Early)	<b>B25-1100</b>	<b>Gaskets</b>	
<b>Chemicals</b>		Gasket - Front Head	Fiber <b>G75-1001</b>
Ultra PAG Oil 100 - 6pk, 8 oz Bottle	<b>MT3013</b>	Gasket - Rear Head	Fiber <b>G75-1002</b>
Ultra PAG Oil 100 - 6pk, Quart Bottle	<b>MT3019</b>	Gasket Kit (Fiber)	Green HNBR <b>K75-2102</b>
Ultra PAG Oil 100 - Drum (52 gal)	<b>A10-6164</b>		
<b>Clutch Components</b>		<p><i>Includes: Front Head Gasket (1), Rear Head Gasket (1), Case O-Ring (1), High Pressure Relief Valve O-Ring (1)</i></p>	
Clutch Hub, Large	<b>H75-7001</b>	<b>Piston Components</b>	
Clutch Hub, Small	<b>H75-7002</b>	Piston Ring (0.76mm) (Standard)	<b>P13-3530</b>
Clutch Pulley - 5 Groove (Small Bearing)	<b>H75-7700</b>	<b>Shaft Seals</b>	
Clutch Pulley - 6 Groove (Large Bearing)	<b>H75-7701</b>	Lip Seal (Black Rubber Coated)	HNBR <b>S20-1007</b>
<b>Control Valves</b>		Lip Seal (Triple)	Nitrile <b>S20-1010</b>
Control Valve (R12) (Requires A13-5132)	<b>A13-5121</b>	Lip Seal Kit	Green HNBR <b>K20-3100</b>
Control Valve (R134a) (Requires A13-5132)	<b>A13-5126</b>		
Control Valve Screen	<b>A13-5132</b>	<p><i>Includes: Shaft Seal Retaining Ring (1), Lip Seal (1)</i></p>	
O-Ring Kit, Control Valve (4 O-Rings)	Green HNBR <b>K13-2122</b>	<b>Shipping Closures</b>	
		Shipping Pad (Use with C11-4103)	<b>C11-3103</b>
<p><i>Includes: Control Valve O-Ring (Inside) (1), Control Valve O-Ring (Inside Center) (1), Control Valve O-Ring (Outside) (1), Control Valve O-Ring (Outside Center) (1)</i></p>		Shipping Plate (Use with C11-3103)	<b>C11-4103</b>
<b>Fasteners</b>		Shipping Plate (Use with C95-3003 & C95-3006)	<b>C95-4001</b>
Bolt - Shaft	<b>F50-2000</b>	Shipping Plug (Discharge) (Use with C95-4001)	<b>C95-3003</b>
Bolt - Shipping Plate	<b>F11-2100</b>	Shipping Plug (Suction) (Use with C95-4001)	<b>C95-3006</b>
Helical Insert - Rear Head / Shipping Plate (8-1.25 x 12mm)	<b>F10-6211</b>	<b>Tools</b>	
Retaining Ring - Control Valve	<b>F13-4115</b>	Helical Insert Drill for 8-1.25mm Inserts	<b>T10-6053</b>
Retaining Ring - Lip Seal	<b>F25-4111</b>		
Shim - Clutch (0.20mm)	<b>F11-3105</b>		
Shim - Clutch (0.38mm)	<b>F12-3110</b>		

## CALSONIC

CWV615, CWV617, CWV618

### Tools

Helical Insert Tap 8-1.25mm	<b>T10-6254</b>
Helical Insert Tool 8-1.25mm - Bolt Style	<b>T10-6554</b>
Shaft Seal Protector	<b>T11-1000</b>
Shaft Seal Protector, Adjustable	<b>T95-1228</b>
Helical Insert Repair Kit (8-1.25mm)	<b>K10-1180</b>



*Includes: Helical Inserts (25), Drill (1), Tap (1), Installation Tool - Bolt Style (1)*



## CALSONIC DKV14D

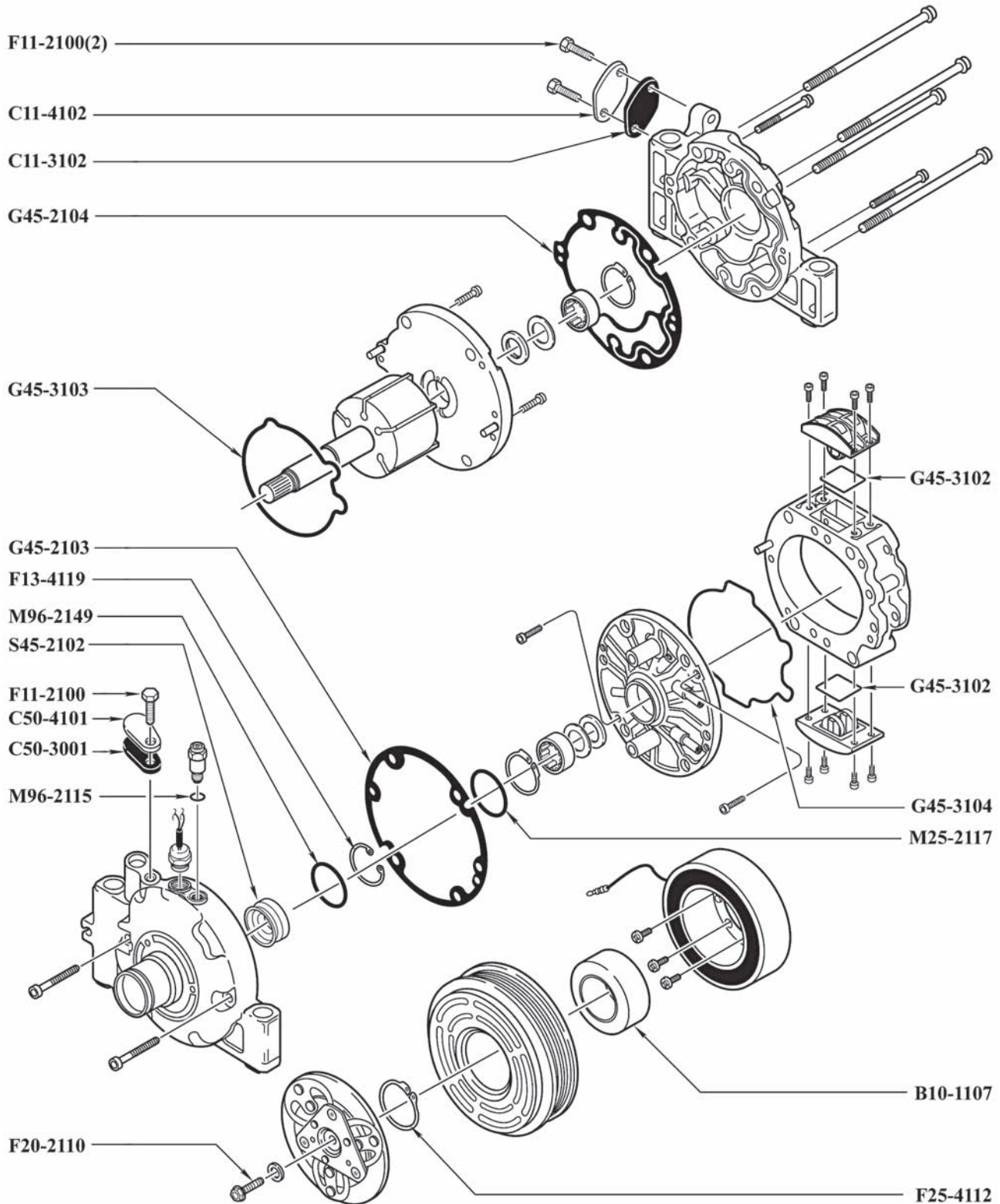

## CALSONIC

### DKV14D

O-Rings	R134a and R-12 Compatible	Green HNBR	Black Nitrile
Internal Front Rotor Housing to Nose O-Ring		<b>M25-2117</b>	<b>M25-1017</b>
Lip Seal O-Ring		<b>M96-2149</b>	
Pressure Relief Valve O-Ring		<b>M96-2115</b>	<b>M96-1015</b>

#### Bearings

Clutch Bearing (35mm x 55mm x 20mm) **B10-1107**

#### Chemicals

Ultra PAG Oil 100 - 6pk, 8 oz Bottle **MT3013**

Ultra PAG Oil 100 - 6pk, Quart Bottle **MT3019**

Ultra PAG Oil 100 - Drum (52 gal) **A10-6164**

#### Fasteners

Bolt - Shaft **F20-2110**

Bolt - Shipping Plate **F11-2100**

Helical Insert - Rear Head / Shipping Plate (8-1.25 x 12mm) **F10-6211**

Retaining Ring - Lip Seal **F13-4119**

Retaining Ring - Pulley **F25-4112**

#### Gaskets

Gasket - Front Head Fiber **G45-1103**

Gasket - Rear Head Fiber **G75-1000**

Gasket - Front Head Metal **G45-2103**

Gasket - Rear Head Metal **G45-2104**

Gasket - Front Molded Green HNBR **G45-3104**

Gasket - Rear Molded Green HNBR **G45-3103**

Gasket - Reed Plate Green HNBR **G45-3102**

Gasket Kit (Fiber) Green HNBR **K75-2101**

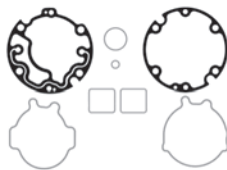

*Includes: Rear Head Gasket (1), Front Head Gasket (1), Reed Plate Molded Gasket (2), Rear Molded Gasket (1), Front Molded Gasket (1), Internal Front Rotor Housing to Nose O-Ring (1), Pressure Relief Valve O-Ring (1)*

#### Shaft Seals

Lip Seal (Black Rubber Coated) HNBR **S20-1006**

Lip Seal (Metal Can) HNBR **S45-2102**

#### Shaft Seals

Lip Seal Kit Green HNBR **K45-3107**



*Includes: Lip Seal Retaining Ring (1), Lip Seal (1)*

#### Shipping Closures

Shipping Pad (Discharge) (Use with C50-4101) **C50-3001**

Shipping Pad (Suction) (Use with C11-4102) **C11-3102**

Shipping Plate (Discharge) (Use with C50-3001) **C50-4101**

Shipping Plate (Suction) (Use with C11-3102) **C11-4102**

Shipping Plate (Use with C95-3003 & C95-3006) **C95-4001**

Shipping Plug (Discharge) (Use with C95-4001) **C95-3003**

Shipping Plug (Suction) (Use with C95-4001) **C95-3006**

#### Tools

Helical Insert Drill for 8-1.25mm Inserts **T10-6053**

Helical Insert Tap 8-1.25mm **T10-6254**

Helical Insert Tool 8-1.25mm - Bolt Style **T10-6554**

Shaft Seal Protector **T11-1000**

Shaft Seal Protector, Adjustable **T95-1228**

Helical Insert Repair Kit (8-1.25mm) **K10-1180**



*Includes: Helical Inserts (25), Drill (1), Tap (1), Installation Tool - Bolt Style (1)*

## CALSONIC

### V5-15C, V5-15F, V5-15G

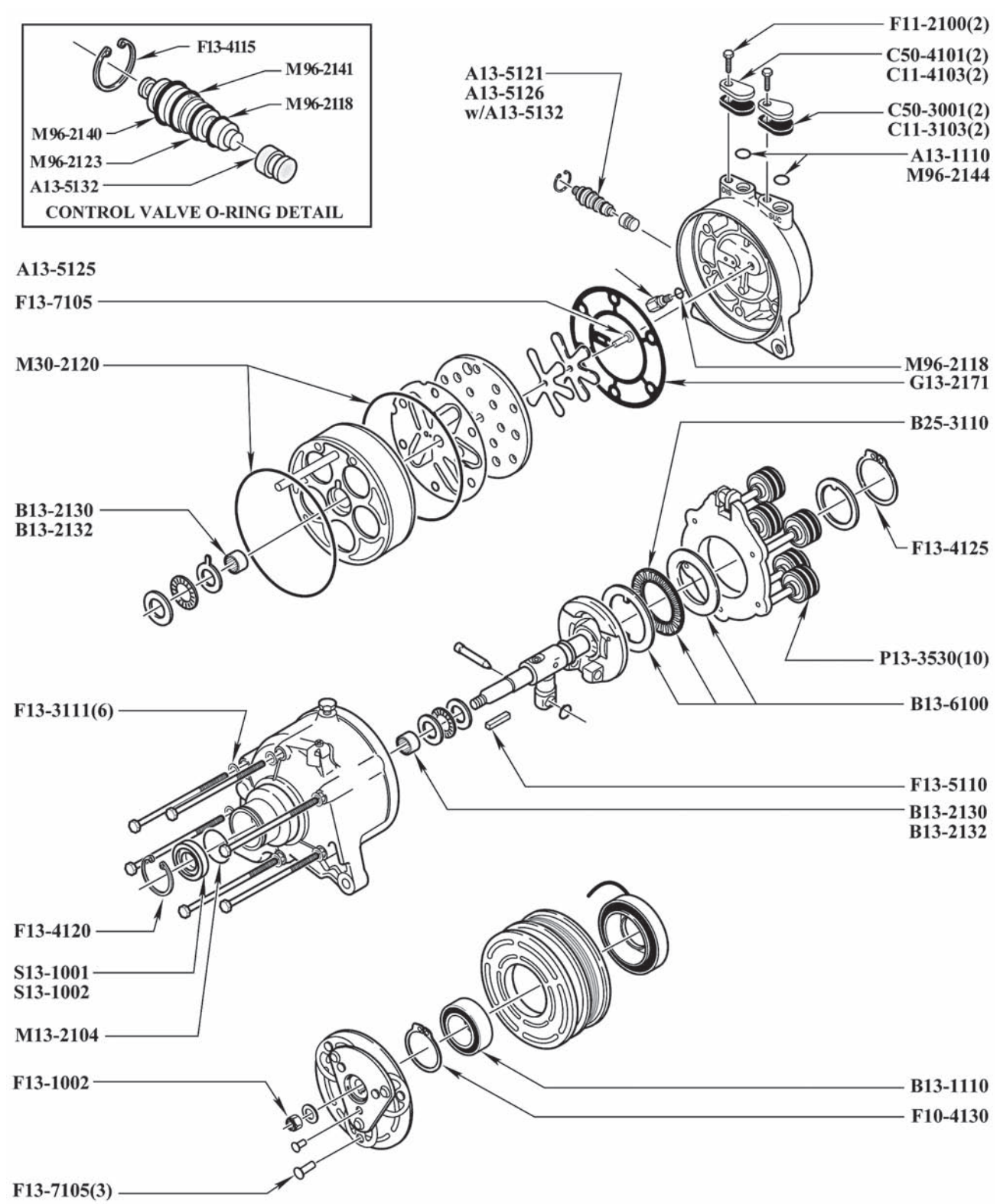

## CALSONIC

### V5-15C, V5-15F, V5-15G

O-Rings	R134a and R-12 Compatible	Green HNBR	Black Nitrile
Case O-Ring		<b>M30-2120</b>	
Control Valve (Inner) / High PSI Relief Valve O-Ring		<b>M96-2118</b>	<b>M96-1018</b>
Control Valve O-Ring (Inside Center)		<b>M96-2123</b>	<b>M96-1023</b>
Control Valve O-Ring (Outside Center)		<b>M96-2141</b>	<b>M96-1041</b>
Control Valve O-Ring (Outside)		<b>M96-2140</b>	<b>M96-1040</b>
Lip Seal O-Ring		<b>M13-2104</b>	<b>M13-1004</b>
Suction / Discharge Port O-Ring		<b>M96-2144</b>	<b>M96-1044</b>
Suction / Discharge Port Oval O-Ring		<b>A13-1110</b>	

Bearings	
Case Bearing (15.9mm x 21.3mm x 12.7mm)	<b>B13-2132</b>
Case Bearing (15.9mm x 21mm x 12.5mm)	<b>B13-2130</b>
Clutch Bearing (40mm x 62mm x 20.6mm)	<b>B13-1110</b>
Thrust Bearing (57.2mm x 79.4mm x 3.2mm)	<b>B25-3110</b>
Thrust Bearing Set	<b>B13-6100</b>

Chemicals	
Ultra PAG Oil 46 - 6pk, 8 oz Bottle	<b>MT3012</b>
Ultra PAG Oil 46 - 6pk, Quart Bottle	<b>MT3018</b>
Ultra PAG Oil 46 - Drum (52 gal)	<b>A10-6163</b>

Control Valves	
Control Valve (R12) (Requires A13-5132)	<b>A13-5121</b>
Control Valve (R134a) (Requires A13-5132)	<b>A13-5126</b>
Control Valve Screen	<b>A13-5132</b>
O-Ring Kit, Control Valve (4 O-Rings)	Green HNBR <b>K13-2122</b>

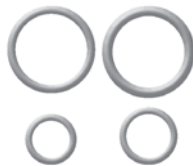

Includes: Control Valve O-Ring (Inside) (1), Control Valve O-Ring (Inside Center) (1), Control Valve O-Ring (Outside) (1), Control Valve O-Ring (Outside Center) (1)

Fasteners	
Bolt - Shipping Plate	<b>F11-2100</b>
Helical Insert - Rear Head / Shipping Plate (8-1.25 x 12mm)	<b>F10-6211</b>
Locknut - Clutch Hub	<b>F13-1002</b>
Rivet - Valve Plate / Clutch Hub	<b>F13-7105</b>
Shaft Key	<b>F13-5110</b>
Retaining Ring - Control Valve	<b>F13-4115</b>
Retaining Ring - Lip Seal (Beveled)	<b>F13-4120</b>
Retaining Ring - Piston Rotator (Beveled)	<b>F13-4125</b>
Retaining Ring - Pulley	<b>F10-4130</b>

Fasteners	
Washer - Head Bolt	<b>F13-3111</b>

Gaskets	
Gasket - Head (6.8mm x 7.7mm Oval Bolt Hole)	Metal <b>G13-2171</b>
Gasket Kit (Metal)	Green HNBR <b>K75-2100</b>

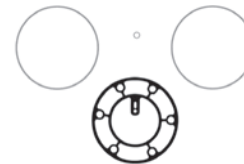

Includes: Head Gasket (Metal) (6.8 mm x 7.7 mm Oval Bolt Hole) (1), Pressure Relief Valve O-Ring (1), Case O-Ring (2)

Piston Components	
Piston Ring (0.76mm) (Standard)	<b>P13-3530</b>

Service Items	
High Pressure Relief Valve	<b>A13-5125</b>

Shaft Seals	
Lip Seal (Double)	Nitrile <b>S13-1002</b>
Lip Seal (Single) (O.E.)	Nitrile <b>S13-1001</b>
Lip Seal Kit (Single Lip Seal)	Green HNBR <b>K13-3125</b>



Includes: Lip Seal Retaining Ring (1), Lip Seal O-Ring (1), Lip Seal (1)

Shipping Closures	
Shipping Pad (Use with C11-4103)	<b>C11-3103</b>
Shipping Pad (Use with C50-4101)	<b>C50-3001</b>
Shipping Plate (Use with C11-3103)	<b>C11-4103</b>
Shipping Plate (Use with C50-3001)	<b>C50-4101</b>
Shipping Plate (Use with C95-3003 & C95-3006)	<b>C95-4001</b>

## CALSONIC

### V5-15C, V5-15F, V5-15G

#### Shipping Closures

Shipping Plug (Discharge) (Use with C95-4001) **C95-3003**

Shipping Plug (Suction) (Use with C95-4001) **C95-3006**

#### Tools

Clutch Plate Installer **T13-3047**

Clutch Plate Remover **T13-3046**

Helical Insert Drill for 8-1.25mm Inserts **T10-6053**

Helical Insert Tap 8-1.25mm **T10-6254**

Helical Insert Tool 8-1.25mm - Bolt Style **T10-6554**

Piston Ring Expansion Cone (Requires T13-3010) **T13-3051**

Piston Ring Installer **T13-3010**

Shaft Seal Protector **T13-1035**

Shaft Seal Protector, Adjustable **T95-1228**

Helical Insert Repair Kit (8-1.25mm) **K10-1180**



*Includes: Helical Inserts (25), Drill (1), Tap (1), Installation Tool - Bolt Style (1)*





## CHRYSLER

6C17

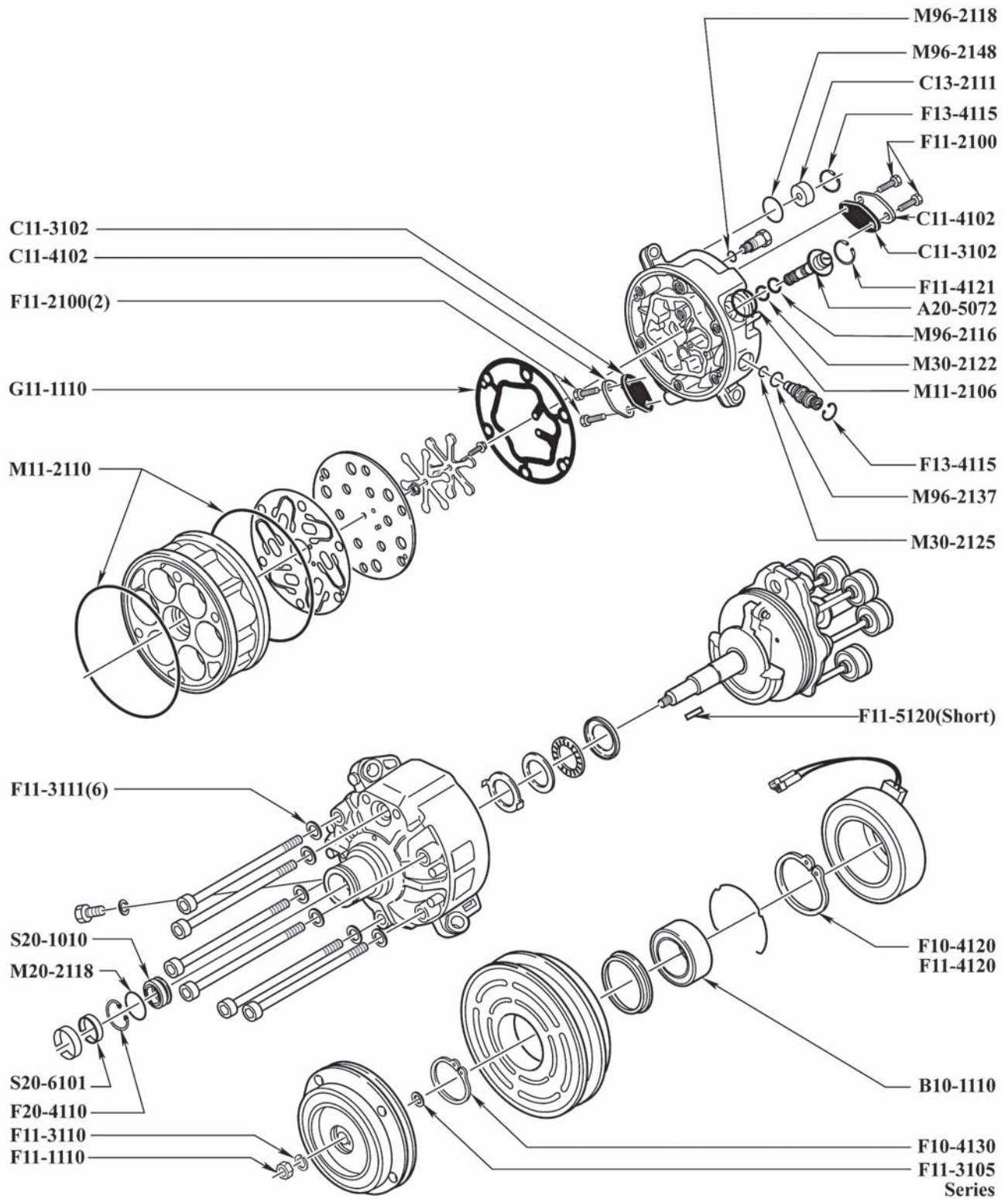

## CHRYSLER

6C17

O-Rings	R134a and R-12 Compatible	Green HNBR	Black Nitrile
Case O-Ring		<b>M11-2110</b>	
High Pressure Relief Valve O-Ring		<b>M96-2118</b>	<b>M96-1018</b>
Lip Seal O-Ring		<b>M20-2118</b>	<b>M20-1018</b>
Long Control Valve O-Ring (Inner)		<b>M30-2122</b>	
Long Control Valve O-Ring (Outer)		<b>M96-2116</b>	<b>M96-1016</b>
Long Control Valve Seat O-Ring		<b>M11-2106</b>	<b>M11-1006</b>
Short Control Valve O-Ring (Inner)		<b>M30-2125</b>	
Short Control Valve O-Ring (Outer)		<b>M96-2137</b>	<b>M96-1037</b>
Switch Port O-Ring		<b>M96-2148</b>	<b>M96-1048</b>

### Bearings

Clutch Bearing (40mm x 62mm x 20.6mm-24mm)	<b>B10-1110</b>
--	-----------------

### Chemicals

Ultra PAG Oil 46 - 6pk, 8 oz Bottle	<b>MT3012</b>
Ultra PAG Oil 46 - 6pk, Quart Bottle	<b>MT3018</b>
Ultra PAG Oil 46 - Drum (52 gal)	<b>A10-6163</b>

### Control Valves

Control Valve, Early	<b>A20-5072</b>
O-Ring Kit, Control Valve	Green HNBR <b>K20-2178</b>



Includes: Control Valve O-Ring (Inside) (1), Control Valve O-Ring (Outside) (1), Control Valve Seat O-Ring (1),

### Fasteners

Bolt - Shipping Plate	<b>F11-2100</b>
Helical Insert - Rear Head / Shipping Plate (8-1.25 x 12mm)	<b>F10-6211</b>
Nut - Shaft	<b>F11-1110</b>
Shaft Key (Short - 11.9mm x 4.0mm)	<b>F11-5120</b>
Retaining Ring - Coil (1.57mm)	<b>F11-4120</b>
Retaining Ring - Coil (1.98mm)	<b>F10-4120</b>
Retaining Ring - Large Control Valve	<b>F11-4121</b>
Retaining Ring - Lip Seal	<b>F20-4110</b>
Retaining Ring - Pulley	<b>F10-4130</b>
Retaining Ring - Switch Port / Small Control Valve	<b>F13-4115</b>
Lockwasher - Shaft	<b>F11-3110</b>
Shim - Clutch (0.20mm)	<b>F11-3105</b>
Shim - Clutch (0.51mm)	<b>F11-3115</b>
Washer - Head Bolt	<b>F11-3111</b>

### Fasteners

Clutch Installation Kit	<b>K20-5110</b>
-------------------------	-----------------



Includes: Coil Retaining Ring (0.078" - 1.198 mm Thick) (1), Coil Retaining Ring - (0.062 - 1.57 mm Thick) (1), Pulley Retaining Ring (1), Shaft Locknut (1), Shaft Lockwasher (1), Hub Shim - .020" Thick (5), Shaft Key (Long) (1), Shaft Key (Short) (1)

### Gaskets

Gasket - Rear Head	Fiber <b>G11-1110</b>
Gasket - Discharge Port	Metal <b>G11-2104</b>
Gasket - Suction / Discharge Port (1991 and later)	Metal <b>G11-2106</b>
Gasket - Suction Port	Metal <b>G11-2105</b>
Gasket Kit (Fiber)	Green HNBR <b>K11-2115</b>



Includes: Retain Rings: Switch Port/Small Control Valve(2), Lip Seal(1), Long Control Valve(1); Cylinder Gasket(1); O-Rings: Case(2), Long Control Valve(3), PRV O-Ring(1), Short Control Valve(2), Lip Seal(1), Sw Port(1); Head Bolt Washer(6).

## CHRYSLER

6C17

### Gaskets

Gasket Kit (Fiber) Black Nitrile **K11-2015**

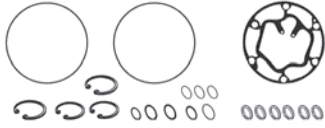

*Includes: Retain Rings: Switch Port/Small Control Valve(2), Lip Seal(1), Long Control Valve(1); Cylinder Gasket(1); O-Rings: Case(2), Long Control Valve(3), PRV O-Ring(1), Short Control Valve(2), Lip Seal(1), Sw Port(1); Head Bolt Washer(6).*

### Shaft Seals

Felt Wiper **S20-6101**

Lip Seal (Triple) Nitrile **S20-1010**

Lip Seal Kit Green HNBR **K20-3130**



*Includes: Lip Seal Retaining Ring (1), Lip Seal (1), Lip Seal O-Ring (1).*

### Shipping Closures

Plug - Aluminum Dummy **C13-2111**

Shipping Pad (Use with C11-4102) **C11-3102**

Shipping Plate (Use with C11-3102) **C11-4102**

Shipping Plate (Use with C95-3004) **C95-4001**

Shipping Plug (Suction/Disch) (Use with C95-4001) **C95-3004**

### Tools

Clutch Hub Remover **T95-1233**

Helical Insert Drill for 8-1.25mm Inserts **T10-6053**

Helical Insert Tap 8-1.25mm **T10-6254**

Helical Insert Tool 8-1.25mm - Bolt Style **T10-6554**

Shaft Seal Protector **T11-1000**

Shaft Seal Protector, Adjustable **T95-1228**

Helical Insert Repair Kit (8-1.25mm) **K10-1180**



*Includes: Helical Inserts (25), Drill (1), Tap (1), Installation Tool - Bolt Style (1)*



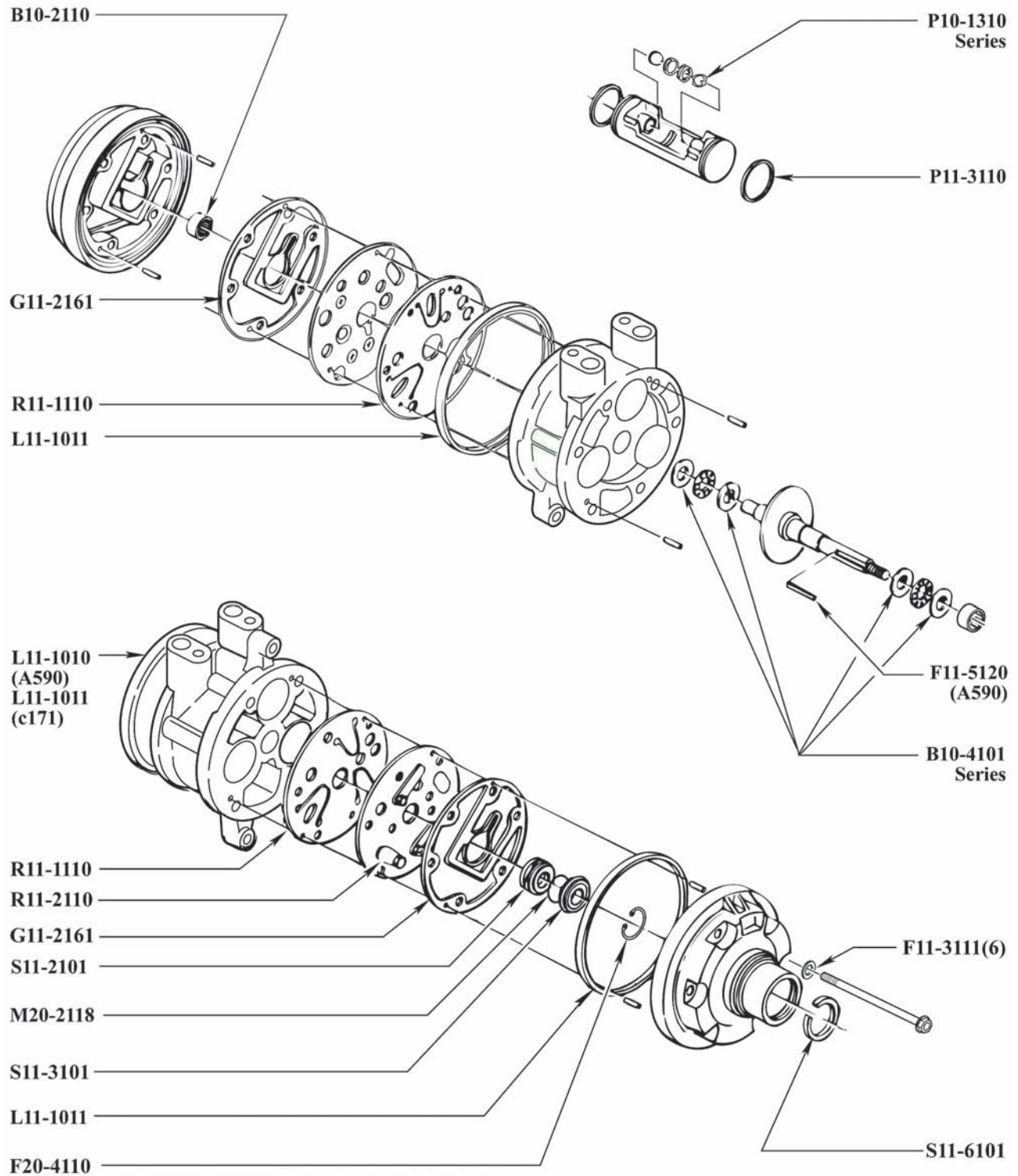

## CHRYSLER

A590, C171



## CHRYSLER

A590, C171

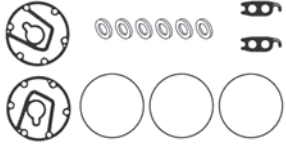
O-Rings and Lathe Cuts	R134a and R-12 Compatible	Green HNBR	Black Nitrile
Carbon Shaft Seal O-Ring		<b>M96-2134</b>	<b>M96-1034</b>
Case Lathe Cut Seal (Center Seal on A590)			<b>L11-1010</b>
Case Lathe Cut Seal (F/R on A590, F/C/R on C171)			<b>L11-1011</b>
Shaft Seal Seat O-Ring		<b>M11-2102</b>	<b>M11-1002</b>
Shaft Seal Seat O-Ring (Use on S11-3101 only)		<b>M20-2118</b>	<b>M20-1018</b>
Suction / Discharge Port O-Ring		<b>M20-2133</b>	
<b>Bearings</b>			
Case Bearing (16.3mm x 22mm x 16mm) (1983 and Later)	<b>B11-2110</b>		
Case Bearing (16mm x 23mm x 21.9mm) (Pre 1983)	<b>B10-2110</b>		
Clutch Bearing (40mm x 62mm x 20.6mm-24mm)	<b>B10-1110</b>		
Thrust Race (2.70mm)	<b>B10-4101</b>		
Thrust Race (2.71mm)	<b>B10-4102</b>		
Thrust Race (2.77mm)	<b>B10-4109</b>		
<b>Chemicals</b>			
Ultra PAG Oil 46 - 6pk, 8 oz Bottle	<b>MT3012</b>		
Ultra PAG Oil 46 - 6pk, Quart Bottle	<b>MT3018</b>		
Ultra PAG Oil 46 - Drum (52 gal)	<b>A10-6163</b>		
<b>Electrical</b>			
Clutch Coil Pigtail	<b>E11-4000</b>		
<b>Fasteners</b>			
Bolt - Shipping Plate	<b>F11-2100</b>		
Helical Insert - Rear Head / Shipping Plate (8-1.25 x 12mm)	<b>F10-6211</b>		
Nut - Shaft	<b>F11-1110</b>		
Shaft Key (Short - 11.9mm x 4.0mm) (A590)	<b>F11-5120</b>		
Retaining Ring - Coil (1.57mm)	<b>F11-4120</b>		
Retaining Ring - Coil (1.98mm)	<b>F10-4120</b>		
Retaining Ring - Pulley	<b>F10-4130</b>		
Retaining Ring - Shaft Seal Seat	<b>F20-4110</b>		
Lockwasher - Shaft	<b>F11-3110</b>		
Shim - Clutch (0.20mm)	<b>F11-3105</b>		
Shim - Clutch (0.38mm)	<b>F12-3110</b>		
Shim - Clutch (0.51mm)	<b>F11-3115</b>		
Washer - Head Bolt	<b>F11-3111</b>		
<b>Fasteners</b>			
Clutch Installation Kit			<b>K20-5110</b>
 <p><i>Includes: Coil Retaining Ring (0.078" - 1.198 mm Thick) (1), Coil Retaining Ring - (0.062 - 1.57 mm Thick) (1), Pully Retaining Ring (1), Shaft Locknut (1), Shaft Lockwasher (1), Hub Shim - .020" Thick (5), Shaft Key (Long) (1), Shaft Key (Short) (1)</i></p>			
<b>Gaskets</b>			
Gasket - Head			Metal <b>G11-2161</b>
Gasket - Suction / Discharge Port			Metal <b>G11-2103</b>
Gasket Kit (Metal) (A590)		Black Nitrile	<b>K11-2005</b>
 <p><i>Includes: Head Bolt Washer (6), Suction / Discharge Port Gasket (Metal) (2), Head Gasket (Metal) (2), Case Lathe Cut Seal (Center) (1), Case Lathe Cut Seal (Front and Rear) (2)</i></p>			
Gasket Kit (Metal) (C171)		Black Nitrile	<b>K11-2010</b>
 <p><i>Includes: Head Bolt Washer (6), Suction / Discharge Port Gasket (Metal) (2), Head Gasket (Metal) (2), Case Lathe Cut Seal (3)</i></p>			

### Piston Components

Piston Ball (13.49mm) (Standard)	<b>P10-1310</b>
Piston Ball (13.50mm) (Oversize)	<b>P10-1315</b>
Piston Ball (13.51mm) (Oversize)	<b>P10-1320</b>
Piston Ring (1.91mm) (Standard)	<b>P11-3110</b>

## CHRYSLER

A590, C171

### Reeds and Valve Plates

Reed - Discharge Valve	<b>R11-2110</b>
Reed - Suction Valve	<b>R11-1110</b>

### Service Items

Fitting (Refrigerant) - 1/8" NPT Brass Port w/ Valve	<b>A10-1024</b>
Fitting (Refrigerant) - 1/8-28 UNF w/Valve/O-Ring	<b>A10-1025</b>

### Shaft Seals

Carbon Shaft Seal	HNBR <b>S11-2101</b>
Felt Wiper	<b>S11-6101</b>
Felt Wiper - Wick Type	<b>S13-4101</b>
Metal Shaft Seal Seat	<b>S11-3101</b>
Carbon Shaft Seal Kit	Green HNBR <b>K20-3115</b>



*Includes: Head Bolt Washer (6), Lip Seal/Metal Shaft Seal Retaining Ring (1), Lip Seal/Metal Shaft Seal Seat O-Ring (Pre-92) (1), Carbon Shaft Seal (Pre-92) (1), Metal Shaft Seal Seat (1)*

### Shipping Closures

Cap - 1/4" Low Side	<b>C10-1000</b>
Shipping Plug	<b>C11-2100</b>
Shipping Pad (Use with C11-4101)	<b>C11-3101</b>
Shipping Plate (Use with 2 C11-3101)	<b>C11-4101</b>
Shipping Plate (Use with C95-3004)	<b>C95-4001</b>
Shipping Plug (Suction/Disch) (Use with C95-4001)	<b>C95-3004</b>

### Tools

Clutch Plate Remover	<b>T13-3042</b>
Clutch Puller	<b>T11-1001</b>
Helical Insert Drill for 8-1.25mm Inserts	<b>T10-6053</b>
Helical Insert Tap 8-1.25mm	<b>T10-6254</b>
Helical Insert Tool 8-1.25mm - Bolt Style	<b>T10-6554</b>
Shaft Seal Protector	<b>T11-1000</b>
Shaft Seal Protector, Adjustable	<b>T95-1228</b>

### Tools

Helical Insert Repair Kit (8-1.25mm)	<b>K10-1180</b>
--------------------------------------	-----------------



*Includes: Helical Inserts (25), Drill (1), Tap (1), Installation Tool - Bolt Style (1)*





## CHRYSLER

### RV2

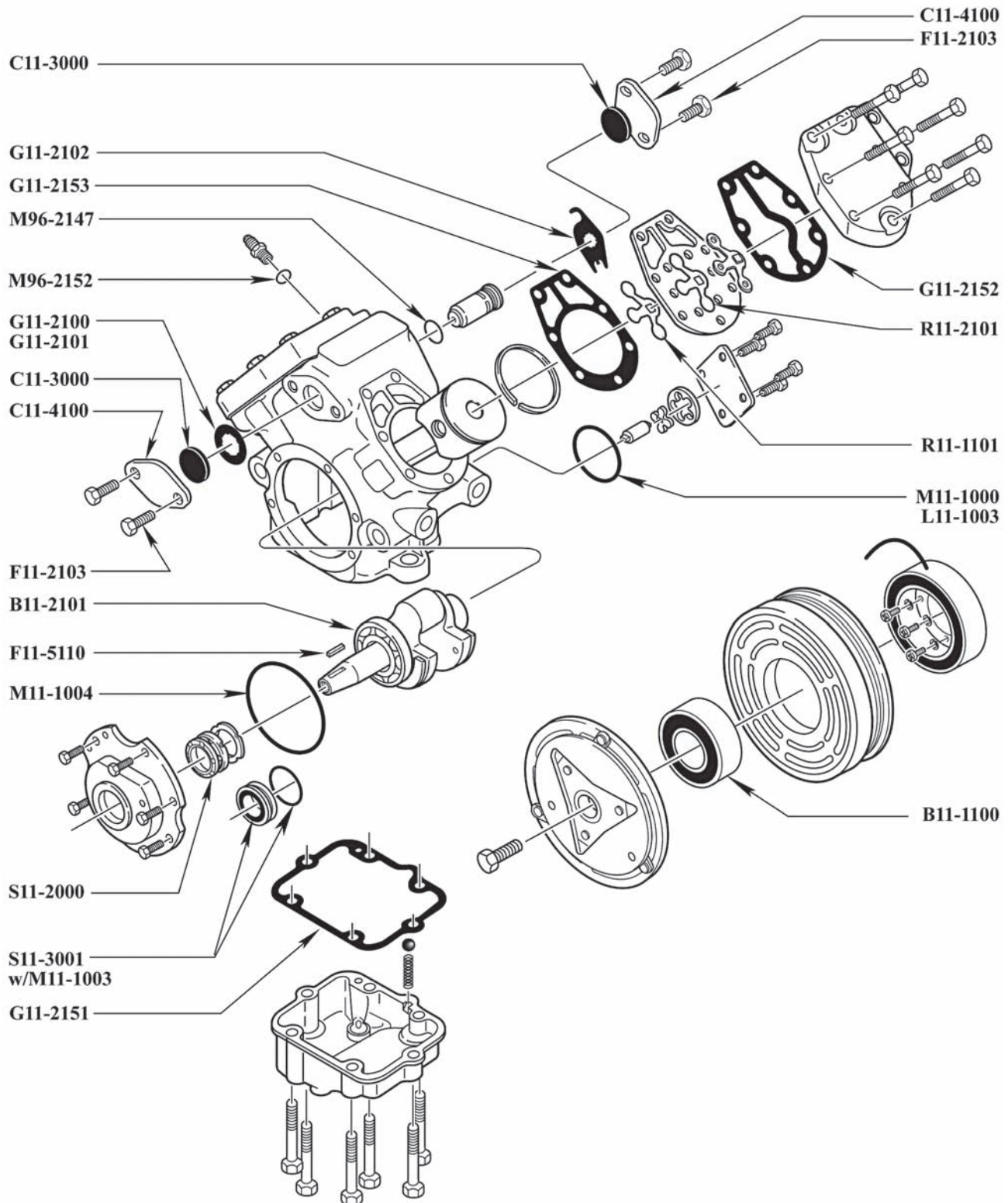

## CHRYSLER

### RV2

O-Rings and Lathe Cuts	R134a and R-12 Compatible	Green HNBR	Black Nitrile
EPR Valve O-Ring		M96-2147	
Nose Plate O-Ring			M11-1004
Oil Drain Plug O-Ring			M11-1000
Oil Pump Lathe Cut Seal			L11-1003
Service Valve O-Ring		M96-2152	M96-1052
Shaft Seal Seat O-Ring			M11-1003

#### Bearings

Case Bearing (25mm x 56mm x 15mm)	B11-2101
Clutch Bearing (30mm x 62mm x 27mm)	B11-1100

#### Chemicals

Ultra PAG Oil 46 - 6pk, 8 oz Bottle	MT3012
Ultra PAG Oil 46 - 6pk, Quart Bottle	MT3018
Ultra PAG Oil 46 - Drum (52 gal)	A10-6163

#### Fasteners

Bolt - Shipping Plate	F11-2103
Shaft Key	F11-5110

#### Gaskets

Gasket - Discharge Port	Fiber G11-1169
Gasket - Suction Port	Fiber G11-1168
Gasket - Base Plate	Metal G11-2151
Gasket - Cylinder	Metal G11-2153
Gasket - Discharge Port	Metal G11-2102
Gasket - Head	Metal G11-2152
Gasket - Suction Port	Metal G11-2101
Gasket - Suction Port (Alternate)	Metal G11-2100

Gasket Kit (Metal) Black Nitrile **K11-2001**



*Includes: Suction Port Gasket (1), Discharge Port Gasket (1), Base Plate Gasket (1), Head Gasket (2), Cylinder gasket (2), Oil Pump O-Ring (1), Shaft Seal Seat O-Ring (1), Nose Plate O-Ring (1).*

#### Reeds and Valve Plates

Reed - Discharge Valve	R11-2101
Reed - Suction Valve	R11-1101

#### Shaft Seals

Carbon Shaft Seal	Nitrile S11-2000
Metal Shaft Seal Seat	S11-3001

#### Shaft Seals

Carbon Shaft Seal Kit Black Nitrile **K11-3001**



*Includes: Carbon Shaft Seal (1), Metal Shaft Seal Seat (1), Metal Shaft Seal Seat O-Ring (1), Nose Plate O-Ring (1)*

#### Shipping Closures

Shipping Pad (Use with C11-4100)	C11-3000
Shipping Plate (Use with C11-3000)	C11-4100

#### Tools

Seal/Plate Alignment Tool	T10-1000
---------------------------	----------

## DAEWOO

V5

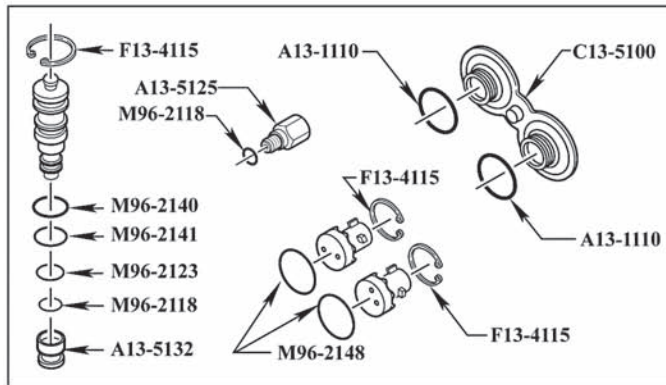

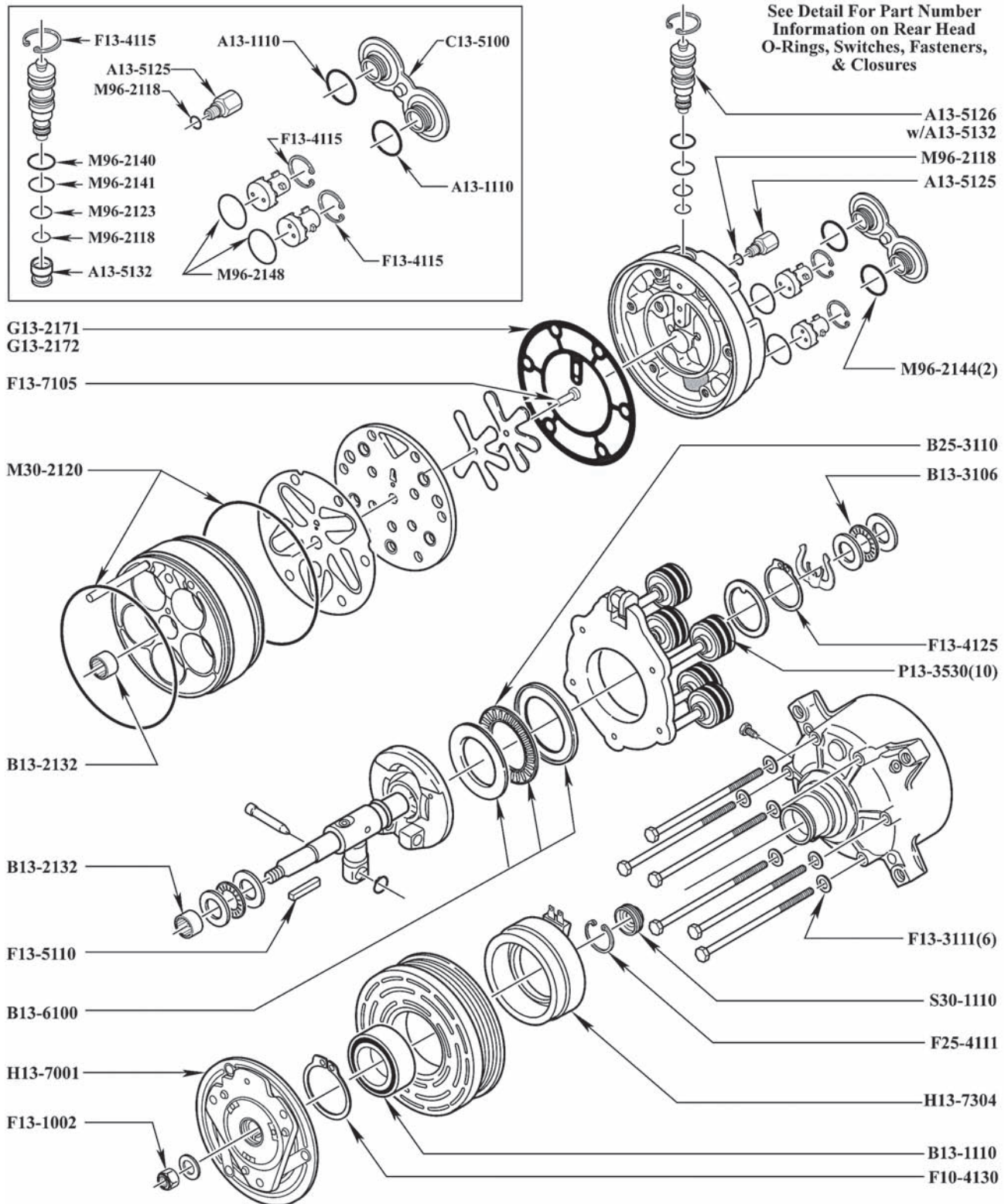

See Detail For Part Number Information on Rear Head O-Rings, Switches, Fasteners, & Closures

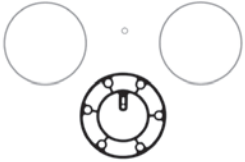

## DAEWOO

### V5

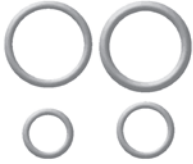
O-Rings	R134a and R-12 Compatible	Green HNBR	Black Nitrile
Case O-Ring		<b>M30-2120</b>	
Control Valve (Inner) / High PSI Relief Valve O-Ring		<b>M96-2118</b>	<b>M96-1018</b>
Control Valve O-Ring (Inside Center)		<b>M96-2123</b>	<b>M96-1023</b>
Control Valve O-Ring (Outside Center)		<b>M96-2141</b>	<b>M96-1041</b>
Control Valve O-Ring (Outside)		<b>M96-2140</b>	<b>M96-1040</b>
Suction / Discharge Port O-Ring		<b>M96-2144</b>	<b>M96-1044</b>
Suction / Discharge Port Oval O-Ring		<b>A13-1110</b>	
Switch Port O-Ring		<b>M96-2148</b>	<b>M96-1048</b>
<b>Bearings</b>		<b>Fasteners</b>	
Case Bearing (15.9mm x 21.3mm x 12.7mm)	<b>B13-2132</b>	Washer - Head Bolt	<b>F13-3111</b>
Clutch Bearing (40mm x 62mm x 20.6mm)	<b>B13-1110</b>	<b>Gaskets</b>	
Thrust Bearing (16mm x 35mm x 4.8mm)	<b>B13-3106</b>	Gasket - Head (6.8mm x 7.7mm Oval Bolt Hole) (92 & Earlier)	Metal <b>G13-2171</b>
Thrust Bearing (57.2mm x 79.4mm x 3.2mm)	<b>B25-3110</b>	Gasket - Head (8.0mm x 8.3mm Oval Bolt Hole) (93 & Later)	Metal <b>G13-2172</b>
Thrust Bearing Set	<b>B13-6100</b>	Gasket Kit (Metal)	Green HNBR <b>K75-2100</b>
<b>Chemicals</b>			
Ultra PAG Oil 100 - 6pk, 8 oz Bottle	<b>MT3013</b>	<i>Includes: Head Gasket (Metal) (6.8 mm x 7.7 mm Oval Bolt Hole) (1), Pressure Relief Valve O-Ring (1), Case O-Ring (2)</i>	
Ultra PAG Oil 100 - 6pk, Quart Bottle	<b>MT3019</b>	<b>Piston Components</b>	
Ultra PAG Oil 100 - Drum (52 gal)	<b>A10-6164</b>	Piston Ring (0.76mm) (Standard)	<b>P13-3530</b>
<b>Clutch Components</b>		<b>Service Items</b>	
Clutch Coil w/Spade - Blue Band	<b>H13-7304</b>	High Pressure Relief Valve	<b>A13-5125</b>
Clutch Hub - Arrowhead Style	<b>H13-7001</b>	<b>Shaft Seals</b>	
<b>Control Valves</b>		Lip Seal (Black Rubber Coated)	Nitrile <b>S13-1005</b>
Control Valve (R134a) (Requires A13-5132)	<b>A13-5126</b>	Lip Seal (Black Rubber Coated)	HNBR <b>S30-1110</b>
Control Valve Screen	<b>A13-5132</b>	Lip Seal Kit	Green HNBR <b>K13-3129</b>
O-Ring Kit, Control Valve (4 O-Rings)	Green HNBR <b>K13-2122</b>		
		<i>Includes: Lip Seal Retaining Ring (1), Lip Seal (1)</i>	
<i>Includes: Control Valve O-Ring (Inside) (1), Control Valve O-Ring (Inside Center) (1), Control Valve O-Ring (Outside) (1), Control Valve O-Ring (Outside Center) (1)</i>		<b>Shipping Closures</b>	
<b>Fasteners</b>		Shipping Closure for O-Rings	<b>C13-5100</b>
Locknut - Clutch Hub	<b>F13-1002</b>		
Rivet - Valve Plate	<b>F13-7105</b>		
Rivet (w/out Hole) - Valve Plate (Destroyer)	<b>F13-7107</b>		
Shaft Key	<b>F13-5110</b>		
Retaining Ring - Control Valve / Switch Port	<b>F13-4115</b>		
Retaining Ring - Lip Seal	<b>F25-4111</b>		
Retaining Ring - Piston Rotator (Beveled)	<b>F13-4125</b>		
Retaining Ring - Pulley	<b>F10-4130</b>		

## DAEWOO

### V5

#### Tools

Clutch Plate Installer	<b>T13-3047</b>
Clutch Plate Remover	<b>T13-3046</b>
Piston Ring Expansion Cone (Requires T13-3010)	<b>T13-3051</b>
Piston Ring Installer	<b>T13-3010</b>
Shaft Seal Protector	<b>T13-1035</b>
Shaft Seal Protector, Adjustable	<b>T95-1228</b>
Shaft Seal Seat Installer / Remover (O.E.)	<b>T60-3001</b>



## DELPHI

### CVC-125, CVC-135, CVC6

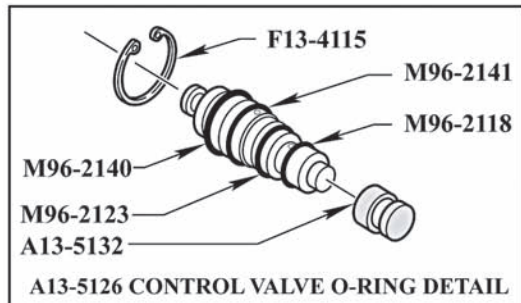

M20-2135(CVC-125)  
M55-2102(CVC-135)

G13-2176  
F13-7105

B25-2113  
S30-1110  
F25-4111

S25-4101  
F20-3000(6)  
M12-2103  
F11-2100  
H14-7003  
H13-7012  
F20-2110

A13-5126  
w/A13-5132

F11-2100  
C13-4100  
C13-3000(2)

M96-2118  
A10-5123

G13-2175  
B13-3106  
B25-3110



F13-4125  
B25-1102

F25-4112  
F25-3109  
Series

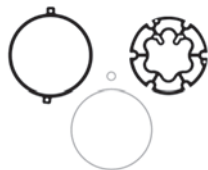

## DELPHI

### CVC-125, CVC-135, CVC6

O-Rings	R134a and R-12 Compatible	Green HNBR	Black Nitrile
Case O-Ring		M20-2135	M20-1035
Case O-Ring		M55-2102	
Control Valve (Inner) / High PSI Relief Valve O-Ring		M96-2118	M96-1018
Control Valve O-Ring (Inside Center)		M96-2123	M96-1023
Control Valve O-Ring (Outside Center)		M96-2141	M96-1041
Control Valve O-Ring (Outside)		M96-2140	M96-1040
Oil Drain Plug O-Ring		M12-2103	M12-1003
<b>Bearings</b>		<b>Fasteners</b>	
Case Bearing (16mm x 22mm x 16mm)	B25-2113	Shim - Clutch (0.76mm)	F25-3109
Clutch Bearing (35mm x 50mm x 20mm)	B25-1102	<b>Gaskets</b>	
Thrust Bearing (16mm x 35mm x 4.76mm)	B13-3106	Gasket - Front Head	Fiber G13-1173
Thrust Bearing (57.2mm x 79.4mm x 3.2mm)	B25-3110	Gasket - Rear Head	Fiber G13-1174
<b>Chemicals</b>		Gasket - Front Head	Metal G13-2175
Ultra PAG Oil 150 - 6pk, 8 oz Bottle	MT3014	Gasket - Rear Head	Metal G13-2176
Ultra PAG Oil 150 - 6pk, Quart Bottle	MT3020	Gasket Kit (Fiber)	Green HNBR K13-2128
Ultra PAG Oil 150 - Drum (52 gal)	A10-6165		
<b>Clutch Components</b>		<i>Includes: Front Head Gasket (1), Rear Head Gasket (1), Case O-Ring (1), High Pressure Relief Valve O-Ring (1)</i>	
Clutch Hub - OD: 105.5mm, Post: 15.71mm	H13-7012	<b>Service Items</b>	
Clutch Hub - OD: 110mm (Renault)	H14-7003	High Pressure Relief Valve M10x1.25 W/O-ring Non Captive	
<b>Control Valves</b>		A10-5123	
Control Valve (R134a) (Requires A13-5132)	A13-5126	<b>Shaft Seals</b>	
Control Valve Screen	A13-5132	Felt Ring	
O-Ring Kit, Control Valve (4 O-Rings)	Green HNBR K13-2122	Lip Seal (Black Rubber Coated)	
		HNBR S30-1110	
<i>Includes: Control Valve O-Ring (Inside) (1), Control Valve O-Ring (Inside Center) (1), Control Valve O-Ring (Outside) (1), Control Valve O-Ring (Outside Center) (1)</i>		Lip Seal Kit	
<b>Fasteners</b>		Black Nitrile K30-3008	
Bolt - Shaft	F20-2110		
Bolt - Shipping Plate/Oil Drain Plug	F11-2100	<i>Includes: Lip Seal Retaining Ring (1), Felt Ring (1), Lip Seal (1)</i>	
Helical Insert - Rear Head / Shipping Plate (8-1.25 x 12mm)	F10-6211	<b>Shipping Closures</b>	
Rivet - Valve Plate	F13-7105	Shipping Pad (Use with C13-4100)	
Retaining Ring - Clutch Coil (Beveled)	F13-4125	Shipping Plate (Rectangular) (Use with 2 C13-3000)	
Retaining Ring - Control Valve	F13-4115	<b>Tools</b>	
Retaining Ring - Lip Seal	F25-4111	Helical Insert Drill for 8-1.25mm Inserts	
Retaining Ring - Pulley	F25-4112	Helical Insert Tap 8-1.25mm	
Shim - Clutch (0.38mm)	F25-3111	T10-6053	
		T10-6254	

## DELPHI

CVC-125, CVC-135, CVC6

### Tools

Helical Insert Tool 8-1.25mm - Bolt Style	<b>T10-6554</b>
Shaft Seal Protector, Adjustable	<b>T95-1226</b>
Helical Insert Repair Kit (8-1.25mm)	<b>K10-1180</b>



*Includes: Helical Inserts (25), Drill (1), Tap (1), Installation Tool - Bolt Style (1)*



## DELPHI CVC-135E

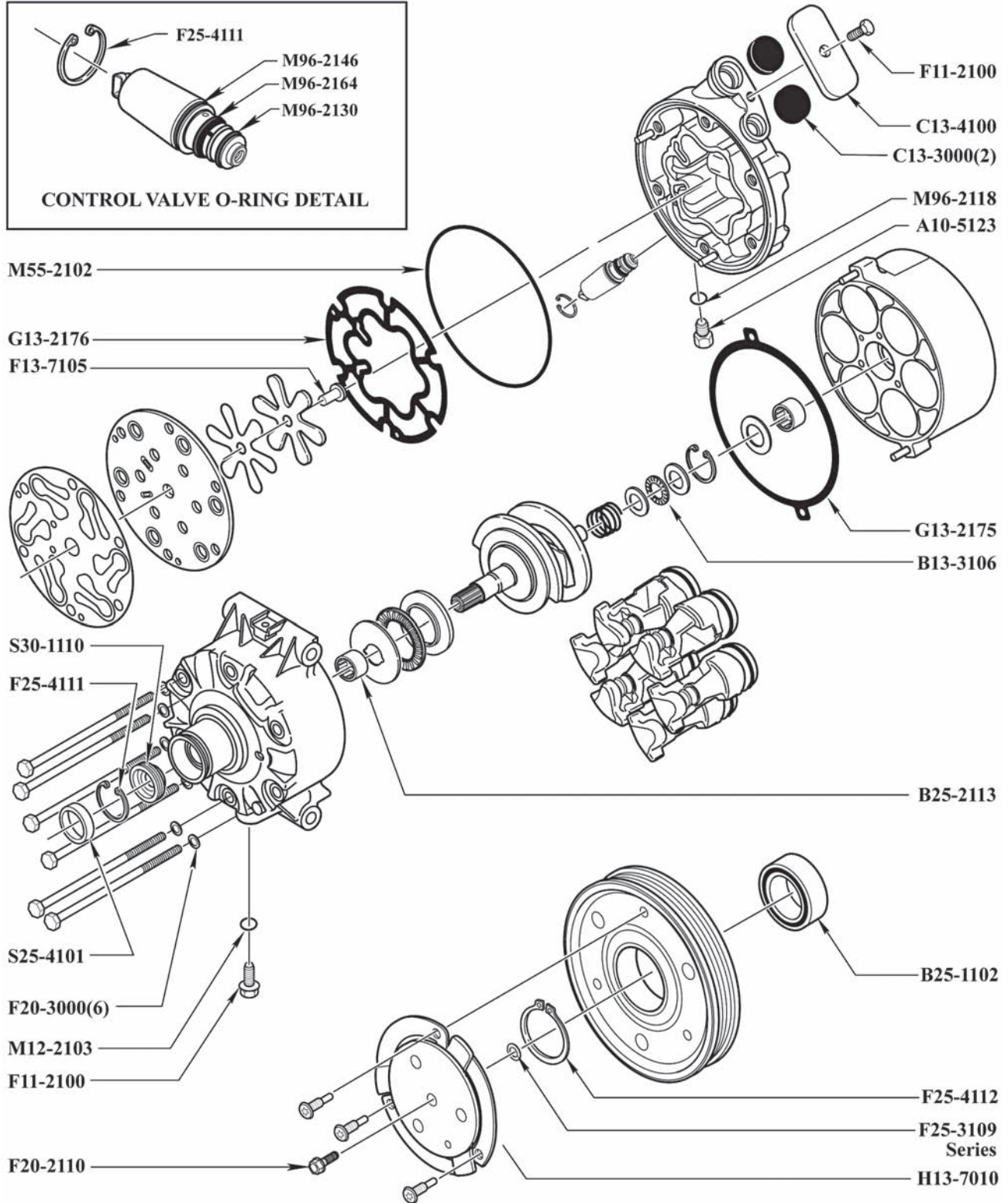
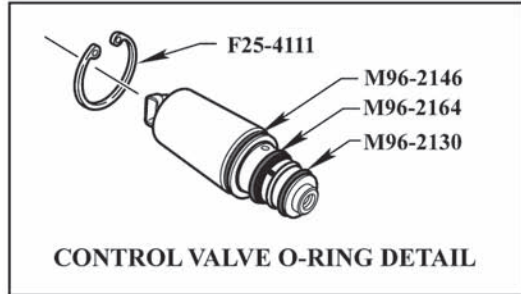

## DELPHI

### CVC-135E

O-Rings	R134a and R-12 Compatible	Green HNBR	Black Nitrile
Case O-Ring		<b>M55-2102</b>	
Control Valve Inner O-Ring		<b>M96-2130</b>	
Control Valve Middle O-Ring		<b>M96-2164</b>	
Control Valve Outer O-Ring		<b>M96-2146</b>	<b>M96-1046</b>
High Pressure Relief Valve O-Ring		<b>M96-2118</b>	<b>M96-1018</b>
Oil Drain Plug O-Ring		<b>M12-2103</b>	<b>M12-1003</b>

Bearings	
Case Bearing (16mm x 22mm x 16mm)	<b>B25-2113</b>
Clutch Bearing (35mm x 50mm x 20mm)	<b>B25-1102</b>
Thrust Bearing (16mm x 35mm x 4.76mm)	<b>B13-3106</b>

Chemicals	
Ultra PAG Oil 150 - 6pk, 8 oz Bottle	<b>MT3014</b>
Ultra PAG Oil 150 - 6pk, Quart Bottle	<b>MT3020</b>
Ultra PAG Oil 150 - Drum (52 gal)	<b>A10-6165</b>

Clutch Components	
Clutch Hub - OD: 86.4mm	<b>H13-7010</b>

Control Valves	
O-Ring Kit, Control Valve (3 O-Rings)	Green HNBR <b>K13-2134</b>



Fasteners	
Bolt - Shaft	<b>F20-2110</b>
Bolt - Shipping Plate/Oil Drain Plug	<b>F11-2100</b>
Helical Insert - Rear Head / Shipping Plate (8-1.25 x 12mm)	<b>F10-6211</b>
Rivet - Valve Plate	<b>F13-7105</b>
Retaining Ring - Clutch Pulley	<b>F25-4112</b>
Retaining Ring - Lip Seal / Control Valve	<b>F25-4111</b>
Washer - Head Bolt	<b>F20-3000</b>
Shim - Clutch (0.38mm)	<b>F25-3111</b>
Shim - Clutch (0.76mm)	<b>F25-3109</b>

Gaskets	
Gasket - Front Head	Fiber <b>G13-1173</b>
Gasket - Rear Head	Fiber <b>G13-1174</b>
Gasket - Front Head	Metal <b>G13-2175</b>
Gasket - Rear Head	Metal <b>G13-2176</b>

Gaskets	
Delphi CVC135E Metal Gasket Kit	Green HNBR <b>K13-2133</b>

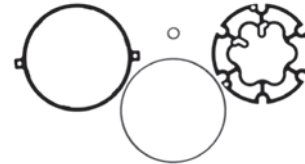

Includes: Front Head Gasket(1), Rear Head Gasket(1), Case O-Rings(3), PRV O-Ring(1)

Gasket Kit (Fiber)	
	Green HNBR <b>K13-2128</b>

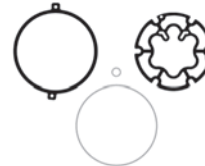

Includes: Front Head Gasket (1), Rear Head Gasket (1), Case O-Ring (1), High Pressure Relief Valve O-Ring (1)

Service Items	
High Pressure Relief Valve M10x1.25 W/O-ring Non Captive	<b>A10-5123</b>

Shaft Seals	
Felt Ring	<b>S25-4101</b>
Lip Seal (Black Rubber Coated)	HNBR <b>S30-1110</b>
Lip Seal Kit	Black Nitrile <b>K30-3008</b>



Includes: Lip Seal Retaining Ring (1), Felt Ring (1), Lip Seal (1)

Shipping Closures	
Shipping Pad (Use with C13-4100)	<b>C13-3000</b>
Shipping Plate (Rectangular) (Use with 2 C13-3000)	<b>C13-4100</b>

## DELPHI

### CVC-135E

#### Tools

Helical Insert Drill for 8-1.25mm Inserts	<b>T10-6053</b>
Helical Insert Tap 8-1.25mm	<b>T10-6254</b>
Helical Insert Tool 8-1.25mm - Bolt Style	<b>T10-6554</b>
Shaft Seal Protector, Adjustable	<b>T95-1227</b>



## DELPHI

### CVC-165, CVC-185, CVC7P

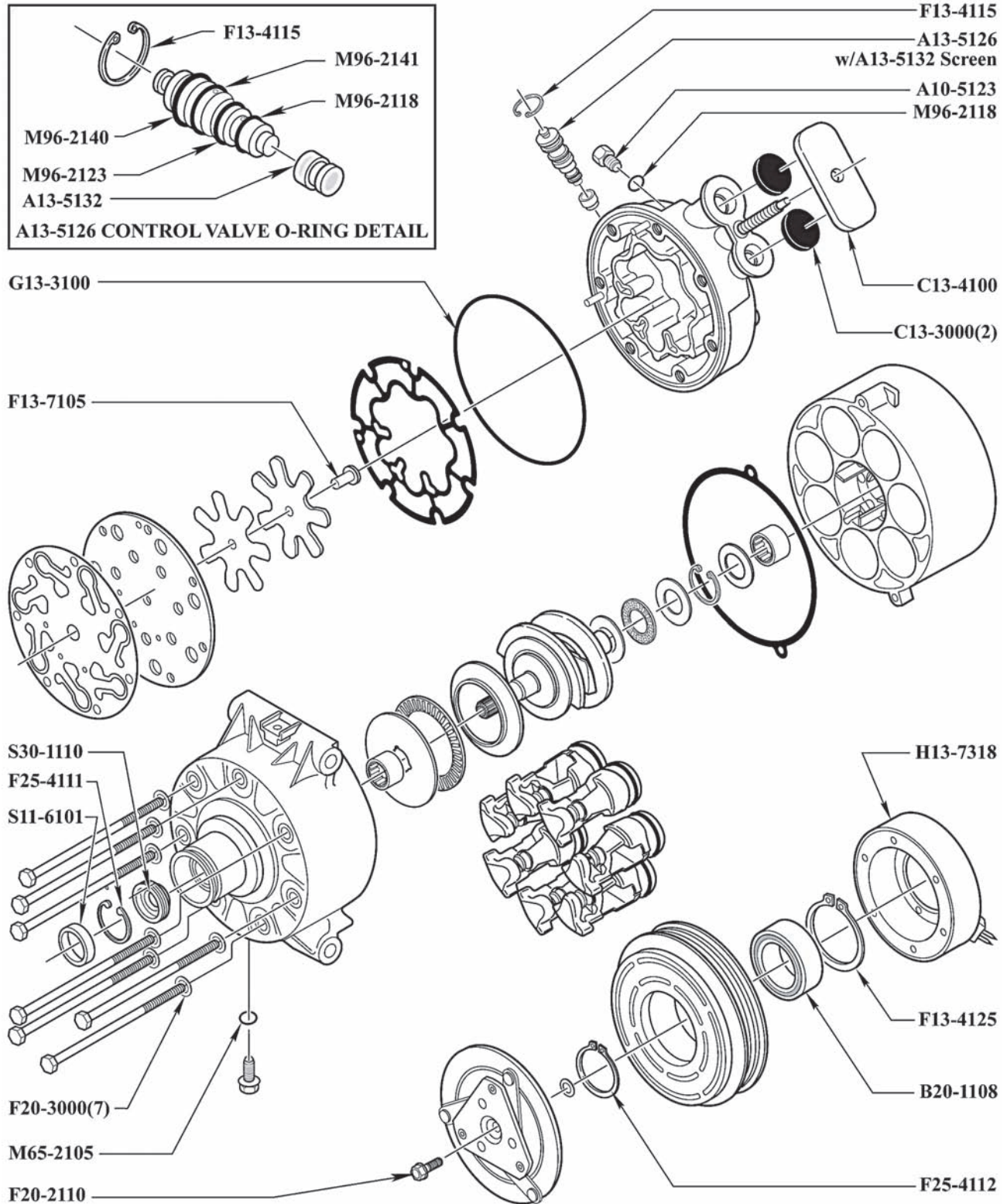
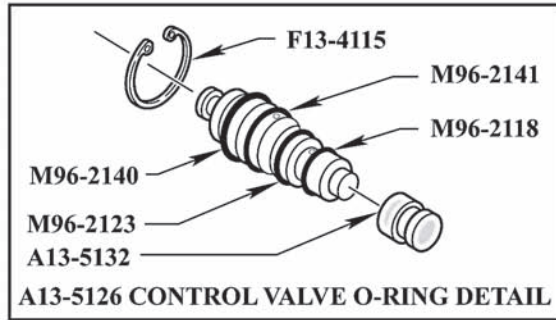



## DELPHI

### CVC-165, CVC-185, CVC7P

O-Rings	R134a and R-12 Compatible	Green HNBR	Black Nitrile
Control Valve (Inner) / High PSI Relief Valve O-Ring		<b>M96-2118</b>	<b>M96-1018</b>
Control Valve O-Ring (Inside Center)		<b>M96-2123</b>	<b>M96-1023</b>
Control Valve O-Ring (Outside Center)		<b>M96-2141</b>	<b>M96-1041</b>
Control Valve O-Ring (Outside)		<b>M96-2140</b>	<b>M96-1040</b>
Oil Drain Plug O-Ring		<b>M65-2105</b>	<b>M65-1005</b>

#### Bearings

Clutch Bearing (35mm x 52mm x 22mm) **B20-1108**

#### Chemicals

Ultra PAG Oil 46 - 6pk, 8 oz Bottle **MT3012**

Ultra PAG Oil 46 - 6pk, Quart Bottle **MT3018**

Ultra PAG Oil 46 - Drum (52 gal) **A10-6163**

#### Clutch Components

Clutch Coil - OD/ID: 103mm / 72mm **H13-7318**

#### Control Valves

Control Valve (R134a) **A13-5228**

Control Valve (R134a) (Requires A13-5132) **A13-5126**

Control Valve Screen **A13-5132**

O-Ring Kit, Control Valve (4 O-Rings) Green HNBR **K13-2122**

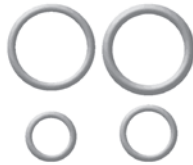

*Includes: Control Valve O-Ring (Inside) (1), Control Valve O-Ring (Inside Center) (1), Control Valve O-Ring (Outside) (1), Control Valve O-Ring (Outside Center) (1)*

#### Fasteners

Bolt - Shaft **F20-2110**

Helical Insert - Rear Head / Shipping Plate (8-1.25 x 12mm) **F10-6211**

Rivet - Valve Plate **F13-7105**

Retaining Ring - Clutch Coil (Beveled) **F13-4125**

Retaining Ring - Control Valve **F13-4115**

Retaining Ring - Lip Seal **F25-4111**

Retaining Ring - Pulley **F25-4112**

Washer - Head Bolt **F20-3000**

#### Gaskets

Gasket - Rear Head Molded Shape - Oval Cross Section Green HNBR **G13-3100**

#### Service Items

High Pressure Relief Valve M10x1.25 W/O-ring Non Captive **A10-5123**

#### Shaft Seals

Felt Wiper **S11-6101**

Lip Seal (Black Rubber Coated) HNBR **S30-1110**

Lip Seal Spacer (Use with S30-1110) **S30-6000**

Lip Seal Kit Green HNBR **K30-1110**



*Includes: Lip Seal Retaining Ring (1), Lip Seal Metal Spacer (1), Lip Seal (1)*

#### Shipping Closures

Shipping Pad (Use with C13-4100) **C13-3000**

Shipping Plate (Rectangular) (Use with 2 C13-3000) **C13-4100**

#### Tools

Helical Insert Drill for 8-1.25mm Inserts **T10-6053**

Helical Insert Tap 8-1.25mm **T10-6254**

Helical Insert Tool 8-1.25mm - Bolt Style **T10-6554**

Shaft Seal Protector, Adjustable **T95-1226**

## DELPHI

### SP10

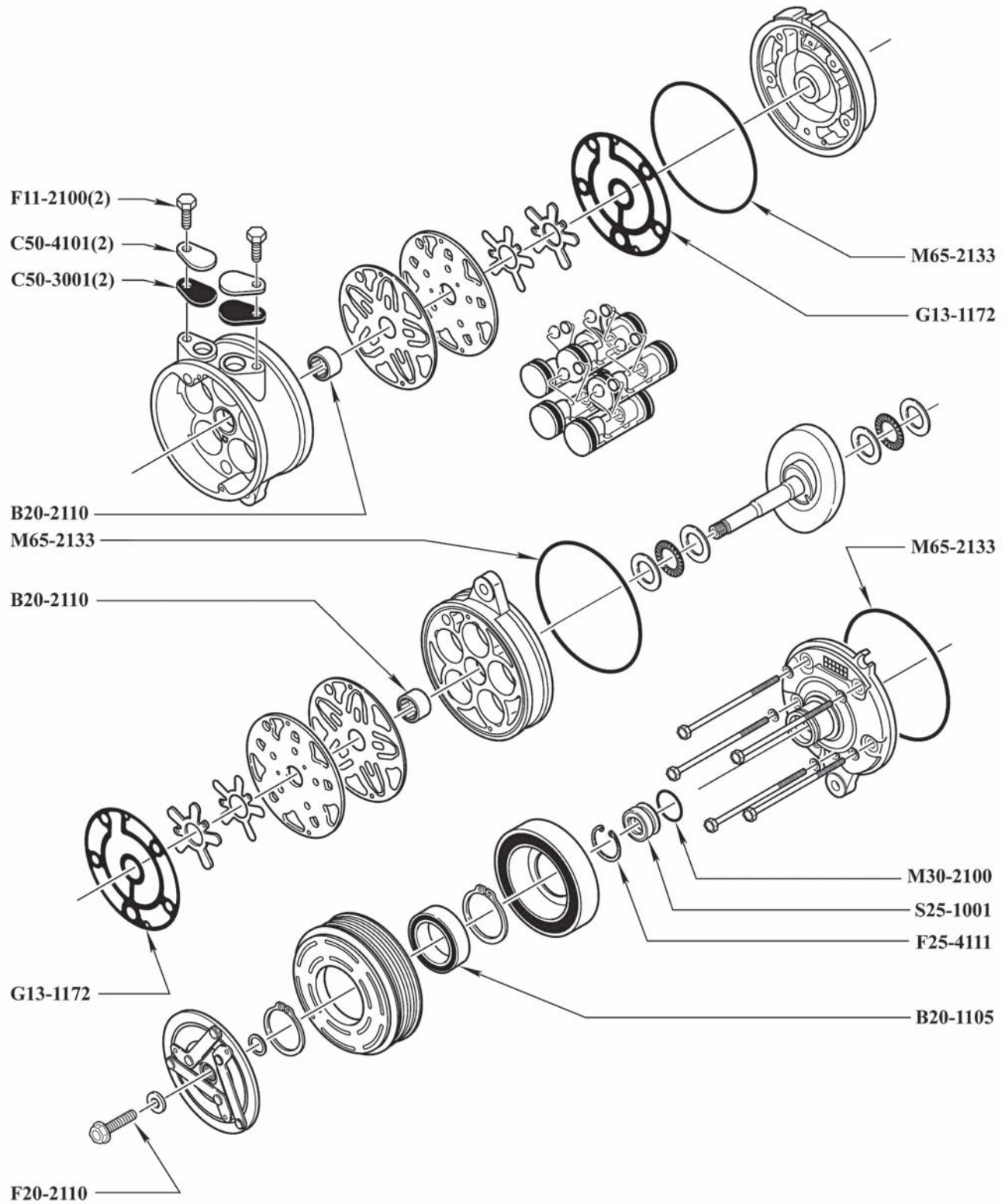

## DELPHI

### SP10

O-Rings	R134a and R-12 Compatible	Green HNBR	Black Nitrile
Case O-Ring		<b>M65-2133</b>	<b>M65-1033</b>
Lip Seal O-Ring		<b>M30-2100</b>	<b>M30-1000</b>

#### Bearings

Case Bearing (16mm x 23mm x 16mm)	<b>B20-2110</b>
Clutch Bearing (38mm x 54mm x 17mm)	<b>B20-1105</b>

#### Chemicals

Ultra PAG Oil 100 - 6pk, 8 oz Bottle	<b>MT3013</b>
Ultra PAG Oil 100 - 6pk, Quart Bottle	<b>MT3019</b>
Ultra PAG Oil 100 - Drum (52 gal)	<b>A10-6164</b>

#### Electrical

GM High Pressure Switch Connector	<b>E13-4003</b>
GM Low Pressure Switch Connector	<b>E13-4002</b>
Condenser Fan Pressure Switch (Purple)	<b>E13-1011</b>
Hi Side Low Pressure Cut-Off Switch (Black)	<b>E13-1018</b>
Hi Side Low Pressure Cut-Off Switch (Brown)	<b>E13-1012</b>
High Pressure Cut-Off Switch (Lt Blue)	<b>E13-1009</b>
High Pressure Cut-Off Switch Kit	<b>E13-1022</b>
Low Pressure Cut-Off Switch Kit	<b>E13-1019</b>
Radiator Fan Pressure Switch (Gray)	<b>E13-1017</b>
Radiator Fan Pressure Switch Kit	<b>E13-1016</b>

#### Fasteners

Bolt - Shaft	<b>F20-2110</b>
Bolt - Shipping Plate	<b>F11-2100</b>
Helical Insert - Rear Head / Shipping Plate (8-1.25 x 12mm)	<b>F10-6211</b>
Retaining Ring - Compressor Switch	<b>F13-4115</b>
Retaining Ring - Lip Seal	<b>F25-4111</b>

#### Gaskets

Gasket - Head	Fiber <b>G13-1172</b>
Gasket Kit (Fiber)	Green HNBR <b>K13-2129</b>

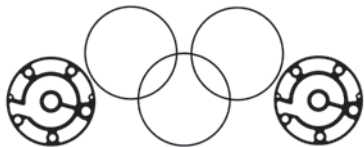

Includes: Head Gasket (2), Case O-Rings (3)

#### Gaskets

Gasket Kit (Fiber)	Black Nitrile <b>K13-2029</b>
--------------------	-------------------------------

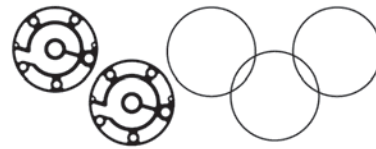

Includes: Head Gasket (2), Case O-Rings (3)

#### Shaft Seals

Felt Ring	<b>S25-4102</b>
Lip Seal	HNBR <b>S25-1001</b>
Lip Seal Kit	Black Nitrile <b>K25-3156</b>



Includes: Lip Seal (1), Lip Seal Felt Ring (1), Lip Seal Retaining Ring (1)

#### Shipping Closures

Shipping Pad (Use with C50-4101)	<b>C50-3001</b>
Shipping Plate (Use with C50-3001)	<b>C50-4101</b>
Shipping Plate (Use with C95-3004 & C95-3006)	<b>C95-4001</b>
Shipping Plug (Discharge) (Use with C95-4001)	<b>C95-3004</b>
Shipping Plug (Suction) (Use with C95-4001)	<b>C95-3006</b>

#### Tools

Helical Insert Drill for 8-1.25mm Inserts	<b>T10-6053</b>
Helical Insert Tap 8-1.25mm	<b>T10-6254</b>
Helical Insert Tool 8-1.25mm - Bolt Style	<b>T10-6554</b>
Shaft Seal Protector	<b>T25-1037</b>
Shaft Seal Protector, Adjustable	<b>T95-1226</b>

## DELPHI

### SP10

#### Tools

Helical Insert Repair Kit (8-1.25mm)

**K10-1180**



*Includes: Helical Inserts (25), Drill (1), Tap (1), Installation Tool - Bolt Style (1)*



## DELPHI

SP15, SP17

Can't find image in the specified name.

## DELPHI

### SP15, SP17

O-Rings	R134a and R-12 Compatible	Green HNBR	Black Nitrile
Case O-Ring		<b>M55-2102</b>	
<b>Bearings</b>			
Case Bearing (16mm x 23mm x 16mm)	<b>B20-2110</b>		
Thrust Bearing (17mm x 34mm x 2.4mm)	<b>B20-3127</b>		
<b>Chemicals</b>			
Ultra PAG Oil 46 - 6pk, 8 oz Bottle	<b>MT3012</b>		
Ultra PAG Oil 46 - 6pk, Quart Bottle	<b>MT3018</b>		
Ultra PAG Oil 46 - Drum (52 gal)	<b>A10-6163</b>		
<b>Clutch Components</b>			
Clutch Hub (06 Tacoma / 07 Ford Fusion 3.0L)	<b>H13-7014</b>		
<b>Fasteners</b>			
Bolt - Shaft	<b>F20-2110</b>		
Bolt - Shipping Plate	<b>F11-2100</b>		
Helical Insert - Rear Head / Shipping Plate (8-1.25 x 12mm)	<b>F10-6211</b>		
Retaining Ring - Lip Seal	<b>F30-4000</b>		
<b>Service Items</b>			
High Pressure Relief Valve M10x1.25 W/O-ring Non Captive	<b>A10-5123</b>		
<b>Shaft Seals</b>			
Lip Seal (Black Rubber Coated)	HNBR <b>S13-1106</b>		
<b>Shipping Closures</b>			
Shipping Plate (Use with C95-3002 & C95-3004)	<b>C95-4001</b>		
Shipping Plug (Discharge) (Use with C95-4001)	<b>C95-3002</b>		
Shipping Plug (Suction) (Use with C95-4001)	<b>C95-3004</b>		
<b>Tools</b>			
Helical Insert Drill for 8-1.25mm Inserts	<b>T10-6053</b>		
Helical Insert Tap 8-1.25mm	<b>T10-6254</b>		
Helical Insert Tool 8-1.25mm - Bolt Style	<b>T10-6554</b>		
Shaft Seal Protector	<b>T25-1037</b>		
Shaft Seal Protector, Adjustable	<b>T95-1226</b>		
Helical Insert Repair Kit (8-1.25mm)	<b>K10-1180</b>		



Includes: Helical Inserts (25), Drill (1), Tap (1), Installation Tool - Bolt Style (1)

## DENSO 5SE09C

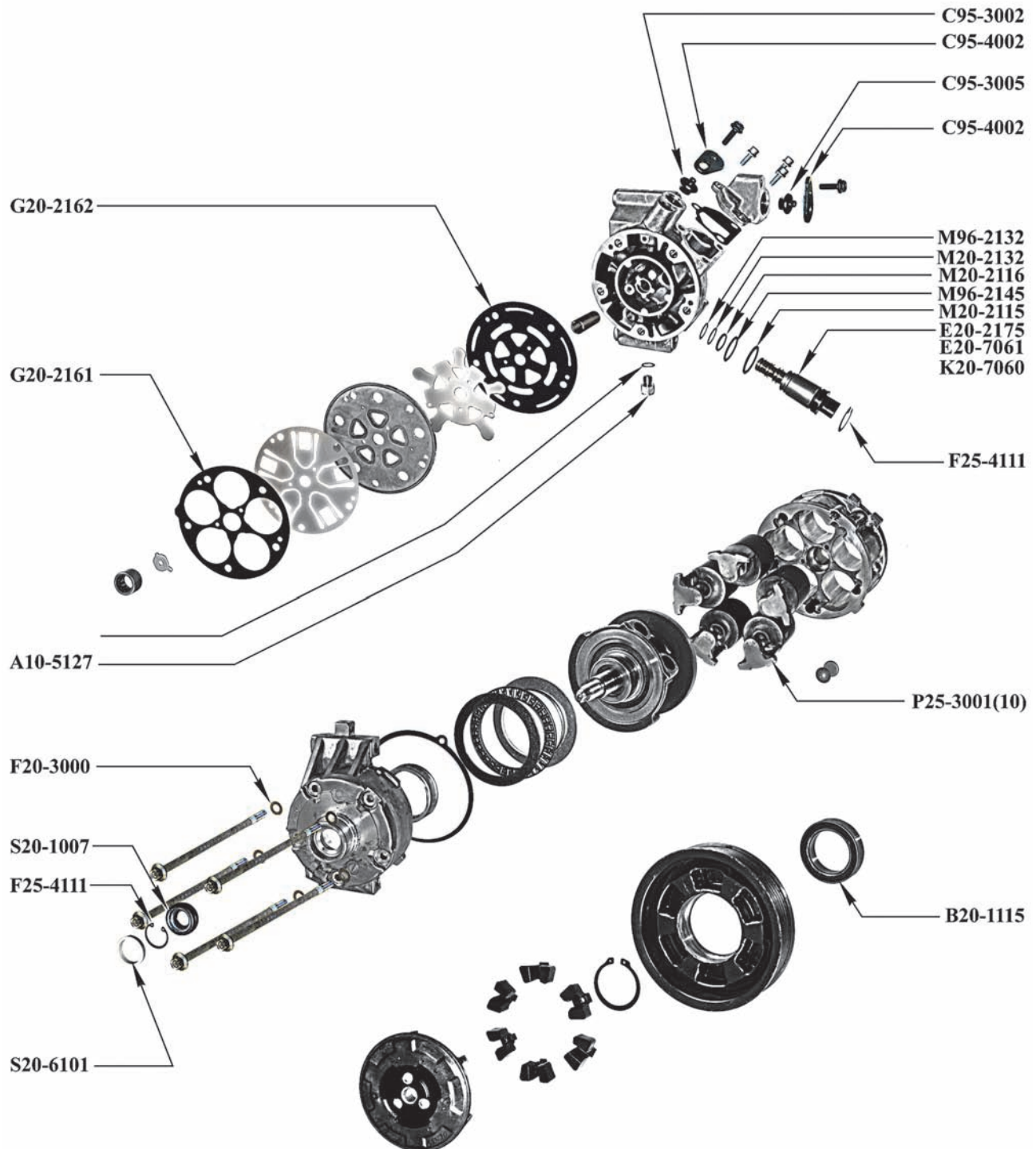



## DENSO 5SE09C

O-Rings	R134a and R-12 Compatible	Green HNBR	Black Nitrile
Control Valve Inner Middle O-Ring		M20-2132	M20-1032
Control Valve Inner O-Ring		M96-2132	M96-1032
Control Valve Middle O-Ring		M20-2116	M20-1016
Control Valve Outer Middle O-Ring		M96-2145	
Control Valve Outer O-Ring		M20-2115	M20-1015
High Pressure Relief Valve O-Ring		M96-2118	M96-1018

### Bearings

Pulley Bearing (35mm x 52mm x 12mm) **B20-1115**

### Chemicals

Ultra PAG Oil 46 - 6pk, 8 oz Bottle **MT3012**

Ultra PAG Oil 46 - 6pk, Quart Bottle **MT3018**

Ultra PAG Oil 46 - Drum (52 gal) **A10-6163**

### Clutch Components

Generation II Direct Drive Hub **H20-7203**

Generation II Direct Drive Hub Rubber Damper **H20-7204**

Generation II Hub Metal Retaining Ring **H20-7208**

### Control Valves

Connector for Electronic Control Valves **E20-4010**

Control Valve (90° Terminal) **E20-7061**

Control Valve (Straight Terminal) **E20-7060**

Control Valve Kit Electronic **K20-2175**



Replaces:  
E20-7010, E20-7011, E20-7012, E20-7013, E20-7015, E20-7017

O-Ring Kit, Control Valve (5 O-Rings) Green HNBR **K20-2165**

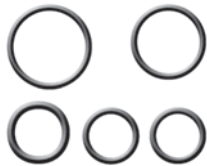

### Electrical

Pigtail - Denso 5SE Control Valve Connector **E95-4020**

### Fasteners

Bolt - Shipping Plate **F20-2110**

Retaining Ring - Clutch Pulley **F25-4112**

Retaining Ring - Lip Seal / Control Valve **F25-4111**

Washer - Head Bolt **F20-3000**

### Gaskets

Denso 5SE09C Cylinder Gasket (Metal) Metal **G20-2161**

Denso 5SE09C Front Head Gasket (Metal) Metal **G20-2160**

Denso 5SE09C Rear Head Gasket (Metal) Metal **G20-2162**

Denso 5SE09C Suction Port Gasket (Metal) Metal **G20-2163**

Gasket Kit Green HNBR **K20-2140**

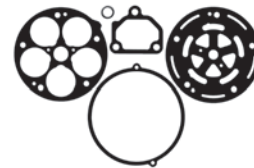

Includes: Front Head Gasket(1), Cylinder Gasket(1), Rear Head Gasket(1), and Suction Cavity Gasket(1)

### Service Items

High Pressure Relief Valve **A20-5203**

### Shaft Seals

Felt Wiper **S20-6101**

Lip Seal (Black Rubber Coated) HNBR **S20-1007**

Lip Seal Kit Green HNBR **K20-3100**



Includes: Shaft Seal Retaining Ring (1), Lip Seal (1)

Lip Seal Kit Green HNBR **K20-3149**



Includes: Retaining Ring (1), Lip Seal (1), Felt Wiper (1)

## DENSO

### 5SE09C

#### Shipping Closures

Shipping Pad (Suction and Discharge) (Use with C50-4101) **C50-3001**

Shipping Plate (Use with C50-3001) **C50-4101**

Shipping Plate (Use with C95-3003 & C95-3005) **C95-4002**

Shipping Plug (Discharge) (Use with C95-4002) **C95-3003**

Shipping Plug (Suction) (Use with C95-4002) **C95-3005**

#### Tools

Shaft Seal Protector, Adjustable **T95-1227**



## DENSO 5SE12C

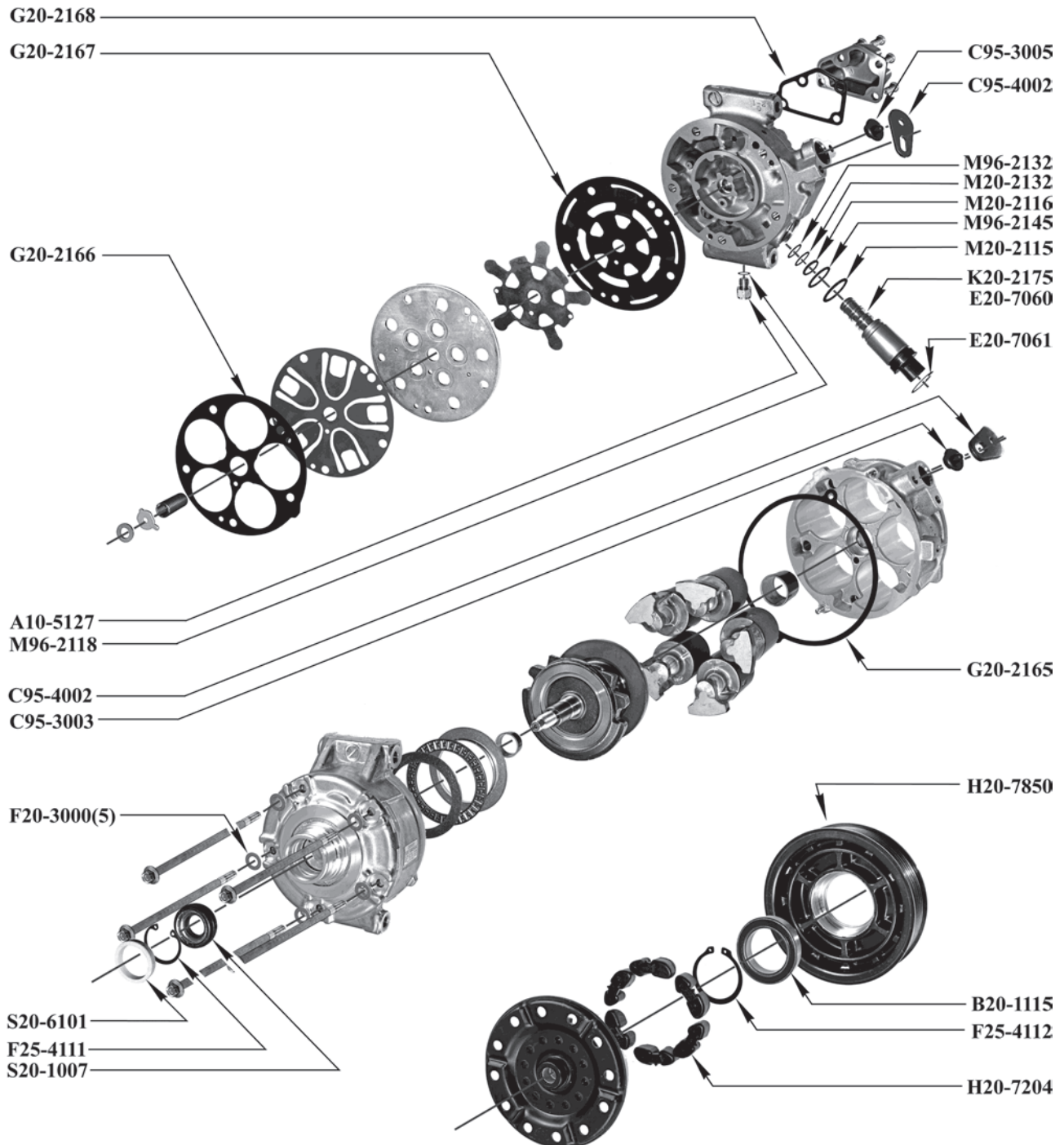

## DENSO

### 5SE12C

O-Rings	R134a and R-12 Compatible	Green HNBR	Black Nitrile
Control Valve Inner Middle O-Ring		M20-2132	M20-1032
Control Valve Inner O-Ring		M96-2132	M96-1032
Control Valve Middle O-Ring		M20-2116	M20-1016
Control Valve Outer Middle O-Ring		M96-2145	
Control Valve Outer O-Ring		M20-2115	M20-1015
High Pressure Relief Valve O-Ring		M96-2118	M96-1018

#### Bearings

Pulley Bearing (35mm x 52mm x 12mm) **B20-1115**

#### Chemicals

Ultra PAG Oil 46 - 6pk, 8 oz Bottle **MT3012**

Ultra PAG Oil 46 - 6pk, Quart Bottle **MT3018**

Ultra PAG Oil 46 - Drum (52 gal) **A10-6163**

#### Clutch Components

Generation II Direct Drive Hub Rubber Damper **H20-7204**

Generation III Metal Pulley - 6 Groove - Total OD: 105 mm **H20-7850**

#### Control Valves

Connector for Electronic Control Valves **E20-4010**

Control Valve (90° Terminal) **E20-7061**

Control Valve (Straight Terminal) **E20-7060**

Control Valve Kit Electronic **K20-2175**



Replaces:  
E20-7010, E20-7011, E20-7012, E20-7013, E20-7015, E20-7017

O-Ring Kit, Control Valve (5 O-Rings) Green HNBR **K20-2165**

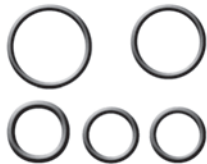

#### Electrical

Pigtail - Denso 5SE Control Valve Connector **E95-4020**

#### Fasteners

Retaining Ring - Lip Seal / Control Valve **F25-4111**

Retaining Ring - Pulley **F25-4112**

Washer - Head Bolt **F20-3000**

#### Gaskets

Denso 5SE12C Cylinder Gasket (Metal) Metal **G20-2166**

Denso 5SE12C Front Head Gasket (Metal) Metal **G20-2165**

Denso 5SE12C Rear Head Gasket (Metal) Metal **G20-2167**

Denso 5SE12C Suction Port Gasket (Metal) Metal **G20-2168**

Gasket Kit Green HNBR **K20-2143**

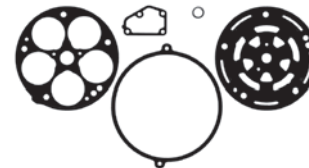

Includes: Front Head Gasket(1), Cylinder Gasket(1), Rear Head Gasket(1), and Suction Cavity Gasket(1)

#### Service Items

High Pressure Relief Valve **A20-5203**

#### Shaft Seals

Felt Wiper **S20-6101**

Lip Seal (Black Rubber Coated) HNBR **S20-1007**

Lip Seal Kit Green HNBR **K20-3100**



Includes: Shaft Seal Retaining Ring (1), Lip Seal (1)

Lip Seal Kit Green HNBR **K20-3149**



Includes: Retaining Ring (1), Lip Seal (1), Felt Wiper (1)

## DENSO

### 5SE12C

#### Shipping Closures

Shipping Pad (Suction and Discharge) (Use with C50-4101) **C50-3001**

Shipping Plate (Use with C50-3001) **C50-4101**

Shipping Plate (Use with C95-3003 & C95-3005) **C95-4002**

Shipping Plug (Discharge) (Use with C95-4002) **C95-3003**

Shipping Plug (Suction) (Use with C95-4002) **C95-3005**

#### Tools

Direct Drive Hub Remover **T20-3006**

Shaft Seal Protector, Adjustable **T95-1227**

## DENSO

5SL12, 5SL12CJ, 5SL142

O-Rings	R134a and R-12 Compatible	Green HNBR	Black Nitrile
Control Valve Inner O-Ring		<b>M96-2171</b>	
Control Valve Middle O-Ring		<b>M96-2155</b>	
Control Valve Outer O-Ring		<b>M20-2164</b>	
<b>Bearings</b>		<b>Shipping Closures</b>	
Clutch Bearing (35mm x 52mm x 12mm)	<b>B20-1115</b>	Shipping Plug (Discharge) (Use with C95-4002)	<b>C95-3003</b>
<b>Chemicals</b>		Shipping Plug (Suction) (Use with C95-4002)	
Ultra PAG Oil 100 - 6pk, 8 oz Bottle	<b>MT3013</b>	<b>C95-3005</b>	
Ultra PAG Oil 100 - 6pk, Quart Bottle	<b>MT3019</b>	<b>Tools</b>	
Ultra PAG Oil 100 - Drum (52 gal)	<b>A10-6164</b>	Helical Insert Drill for 8-1.25mm Inserts	<b>T10-6053</b>
<b>Control Valves</b>		Helical Insert Tap 8-1.25mm	<b>T10-6254</b>
Control Valve Filter	<b>A20-5121</b>	Helical Insert Tool 8-1.25mm - Bolt Style	<b>T10-6554</b>
Main Control Valve	<b>A20-5071</b>	Shaft Seal Protector	<b>T11-1000</b>
O-Ring Kit, Control Valve (3 O-Rings)	Green HNBR <b>K20-2176</b>	Shaft Seal Protector, Adjustable	<b>T95-1228</b>
		Helical Insert Repair Kit (8-1.25mm)	<b>K10-1180</b>



Includes: Helical Inserts (25), Drill (1), Tap (1), Installation Tool - Bolt Style (1)

<b>Fasteners</b>	
Bolt - Shipping Plate	<b>F20-2110</b>
Helical Insert - Rear Head / Shipping Plate (8-1.25 x 12mm)	<b>F10-6211</b>
Retaining Ring - Coil	<b>F10-4130</b>
Retaining Ring - Control Valve	<b>F11-4121</b>
Retaining Ring - Lip Seal	<b>F25-4111</b>
Retaining Ring - Pulley	<b>F12-4110</b>
Washer - Head Bolt	<b>F20-3000</b>

<b>Shaft Seals</b>	
Lip Seal (Black Rubber Coated)	HNBR <b>S20-1007</b>
Lip Seal Kit	Green HNBR <b>K20-3100</b>



Includes: Shaft Seal Retaining Ring (1), Lip Seal (1)

<b>Shipping Closures</b>	
Shipping Plate (Use with C95-3003 & C95-3005)	<b>C95-4002</b>

## DENSO 6CA17C

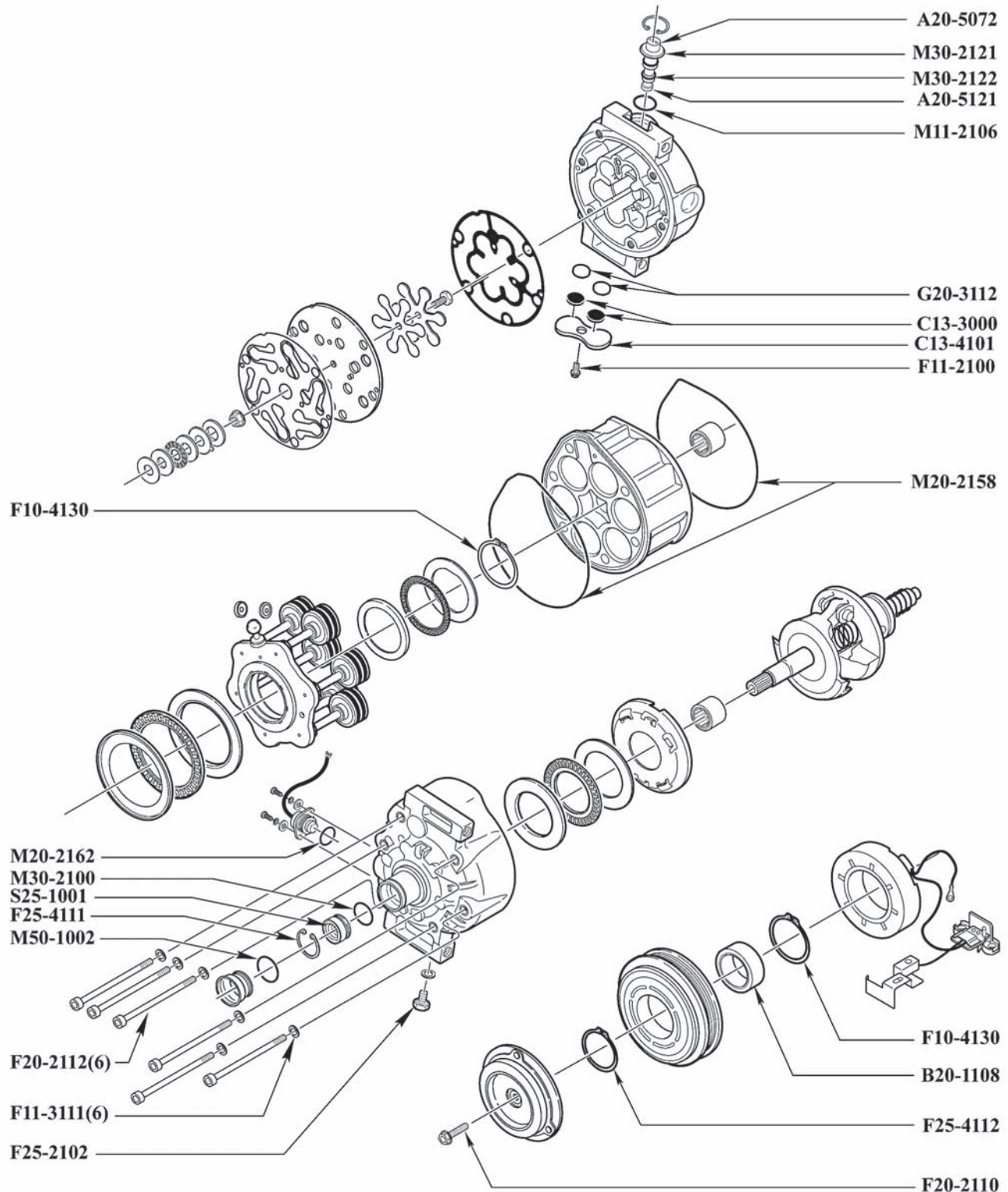



## DENSO

### 6CA17C

O-Rings	R134a and R-12 Compatible	Green HNBR	Black Nitrile
Case O-Ring		<b>M20-2158</b>	<b>M20-1058</b>
Control Valve Inner O-Ring		<b>M30-2122</b>	
Control Valve Outer O-Ring		<b>M30-2121</b>	
Control Valve Seat O-Ring		<b>M11-2106</b>	<b>M11-1006</b>
Lip Seal O-Ring		<b>M30-2100</b>	<b>M30-1000</b>
Suction/Discharge O-Ring w/Tabs		<b>G20-3112</b>	
Suction/Discharge/Dust Shield O-Ring			<b>M50-1002</b>
Temperature Switch O-Ring		<b>M20-2162</b>	

#### Bearings

Clutch Bearing (35mm x 52mm x 22mm) **B20-1108**

#### Chemicals

Ultra PAG Oil 46 - 6pk, 8 oz Bottle **MT3012**

Ultra PAG Oil 46 - 6pk, Quart Bottle **MT3018**

Ultra PAG Oil 46 - Drum (52 gal) **A10-6163**

#### Control Valves

Control Valve Filter **A20-5121**

Control Valve, Early **A20-5072**

O-Ring Kit, Control Valve (3 O-Rings) Green HNBR **K20-2178**



*Includes: Control Valve O-Ring (Inside) (1), Control Valve O-Ring (Outside) (1), Control Valve Seat O-Ring (1),*

#### Fasteners

Bolt - Head **F20-2112**

Bolt - Oil Plug **F25-2102**

Bolt - Shaft **F20-2110**

Bolt - Shipping Plate **F11-2100**

Helical Insert - Rear Head / Shipping Plate (8-1.25 x 12mm) **F10-6211**

Retaining Ring - Clutch Pulley **F25-4112**

Retaining Ring - Lip Seal **F25-4111**

Retaining Ring - Piston Assembly / Clutch Coil **F10-4130**

Washer - Head Bolt **F11-3111**

#### Gaskets

Gasket Kit Green HNBR **K20-2168**

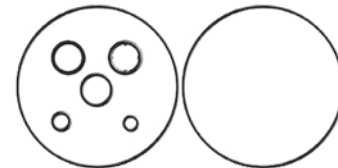

*Control Valve O-Ring(Outer)(1), Control Valve O-Ring(Inner)(1), Control Valve Set O-Ring(1), Suction/Discharge O-Ring(2), Case O-Ring(2).*

#### Shaft Seals

Lip Seal HNBR **S25-1001**

Lip Seal Kit Black Nitrile **K25-3156**



*Includes: Lip Seal (1), Lip Seal Felt Ring (1), Lip Seal Retaining Ring (1).*

#### Shipping Closures

Shipping Pad (Use with C13-4101) **C13-3000**

Shipping Plate (Rounded) (Use with 2 C13-3000) **C13-4101**

#### Tools

Helical Insert Drill for 8-1.25mm Inserts **T10-6053**

Helical Insert Tap 8-1.25mm **T10-6254**

Helical Insert Tool 8-1.25mm - Bolt Style **T10-6554**

Shaft Seal Protector, Adjustable **T95-1227**

## DENSO

### 6E171, 6E171A

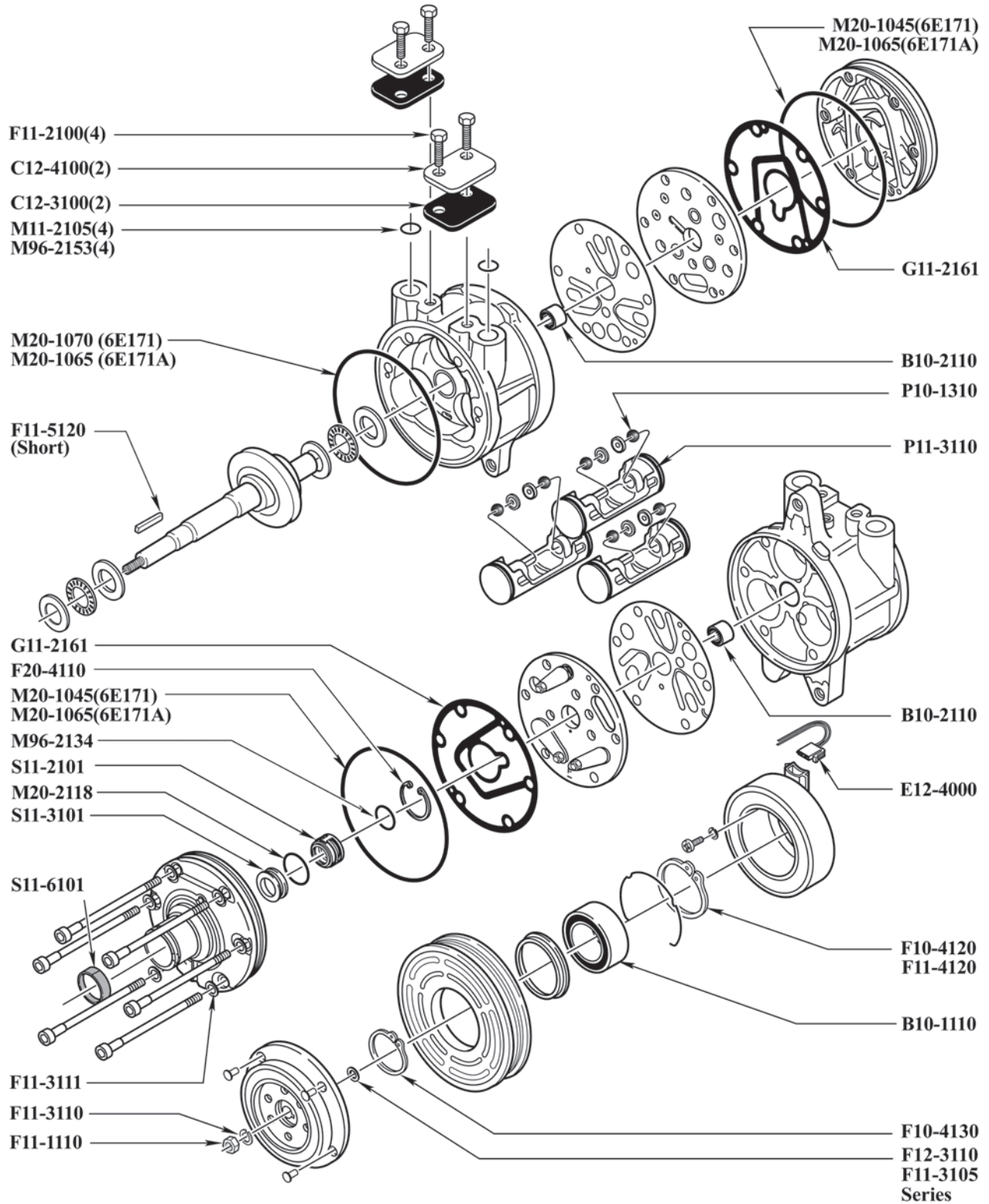

## DENSO

### 6E171, 6E171A

O-Rings	R134a and R-12 Compatible	Green HNBR	Black Nitrile
Carbon Shaft Seal O-Ring		<b>M96-2134</b>	<b>M96-1034</b>
Case O-Ring (Front, Rear & Center) (6E171A)			<b>M20-1065</b>
Case O-Ring (Center) (6E171)			<b>M20-1070</b>
Case O-Ring (Front & Rear) (6E171)			<b>M20-1045</b>
Shaft Seal Seat O-Ring		<b>M20-2118</b>	<b>M20-1018</b>
Suction / Discharge Port O-Ring (Aftermarket Hose Assembly)		<b>M11-2105</b>	<b>M11-1005</b>
Suction / Discharge Port O-Ring (Factory Hose Assembly)		<b>M96-2153</b>	<b>M96-1053</b>

#### Bearings

Case Bearing (16mm x 23mm x 21.9mm)	<b>B10-2110</b>
Clutch Bearing (40mm x 62mm x 20.6mm-24mm)	<b>B10-1110</b>

#### Chemicals

Ultra PAG Oil 46 - 6pk, 8 oz Bottle	<b>MT3012</b>
Ultra PAG Oil 46 - 6pk, Quart Bottle	<b>MT3018</b>
Ultra PAG Oil 46 - Drum (52 gal)	<b>A10-6163</b>

#### Electrical

Clutch Coil Pigtail	<b>E12-4000</b>
---------------------	-----------------

#### Fasteners

Bolt - Shipping Plate	<b>F11-2100</b>
Helical Insert - Rear Head / Shipping Plate (8-1.25 x 12mm)	<b>F10-6211</b>
Nut - Shaft	<b>F11-1110</b>
Shaft Key (Short - 11.9mm x 4.0mm)	<b>F11-5120</b>
Retaining Ring - Coil (1.57mm)	<b>F11-4120</b>
Retaining Ring - Coil (1.98mm)	<b>F10-4120</b>
Retaining Ring - Pulley	<b>F10-4130</b>
Retaining Ring - Shaft Seal Seat	<b>F20-4110</b>
Lockwasher - Shaft	<b>F11-3110</b>
Shim - Clutch (0.20mm)	<b>F11-3105</b>
Shim - Clutch (0.38mm)	<b>F12-3110</b>
Shim - Clutch (0.51mm)	<b>F11-3115</b>
Washer - Head Bolt	<b>F11-3111</b>
Clutch Installation Kit	<b>K20-5010</b>



Includes: Coil Retaining Ring (0.078" - 1.198 mm Thick) (1), Coil Retaining Ring - (0.062 - 1.57 mm Thick) (1), Pulley Retaining Ring (1), Shaft Locknut (1), Shaft Lockwasher (1), Hub Shim - .020" Thick (5)

#### Fasteners

Clutch Installation Kit	<b>K20-5110</b>
-------------------------	-----------------



Includes: Coil Retaining Ring (0.078" - 1.198 mm Thick) (1), Coil Retaining Ring - (0.062 - 1.57 mm Thick) (1), Pulley Retaining Ring (1), Shaft Locknut (1), Shaft Lockwasher (1), Hub Shim - .020" Thick (5), Shaft Key (Long) (1), Shaft Key (Short) (1)

#### Gaskets

Gasket - Head	Metal <b>G11-2161</b>
Gasket Kit (Metal) (6E171 only)	Black Nitrile <b>K20-2005</b>

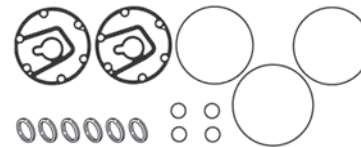

Includes: Head Bolt Washer (6), Head Gasket (Metal) (2), Case O-Ring (Front & Rear) (2), Case O-Ring (Center) (1), Suction / Discharge Port O-Ring (4)

#### Piston Components

Piston Ball (13.49mm) (Standard)	<b>P10-1310</b>
Piston Ball (13.50mm) (Oversize)	<b>P10-1315</b>
Piston Ball (13.51mm) (Oversize)	<b>P10-1320</b>
Piston Ring (1.91mm) (Standard)	<b>P11-3110</b>

#### Service Items

Fitting (Refrigerant) - 1/8" NPT Brass Port w/ Valve	<b>A10-1024</b>
--	-----------------

#### Shaft Seals

Carbon Shaft Seal	HNBR <b>S11-2101</b>
Felt Wiper	<b>S11-6101</b>
Metal Shaft Seal Seat	<b>S11-3101</b>

## DENSO

6E171, 6E171A

### Shaft Seals

Carbon Shaft Seal Kit

Black Nitrile **K20-3005**

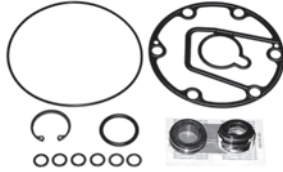

*Includes: Shaft Seal Retaining Ring (1), Carbon Seal (1), Seal Seat (1), Shaft Seal Seat O-Ring (1), Head Bolt Washers (6), Valve Plate Gasket (1), Case O-Ring (1)*

Carbon Shaft Seal Kit

Green HNBR **K20-3115**



*Includes: Head Bolt Washer (6), Lip Seal/Metal Shaft Seal Retaining Ring (1), Lip Seal/Metal Shaft Seal Seat O-Ring (Pre-92) (1), Carbon Shaft Seal (Pre-92) (1), Metal Shaft Seal Seat (1)*

### Tools

Helical Insert Repair Kit (8-1.25mm)

**K10-1180**



*Includes: Helical Inserts (25), Drill (1), Tap (1), Installation Tool - Bolt Style (1)*

### Shipping Closures

Cap - 1/4" Low Side **C10-1000**

Shipping Pad (Use with C12-4100 or C12-4101) **C12-3100**

Shipping Plate (Use with 2 C12-3100) (Covers all 4 ports) **C12-4101**

Shipping Plate (Use with C12-3100) **C12-4100**

Shipping Plate (Use with C95-3002 & C95-3003) **C95-4001**

Shipping Plug (Discharge) (Use with C95-4001) **C95-3003**

Shipping Plug (Suction) (Use with C95-4001) **C95-3002**

### Tools

Helical Insert Drill for 8-1.25mm Inserts **T10-6053**

Helical Insert Tap 8-1.25mm **T10-6254**

Helical Insert Tool 8-1.25mm - Bolt Style **T10-6554**

Shaft Seal Installer / Remover (Aftermarket) **T20-3002**

Shaft Seal Protector **T11-1000**

Shaft Seal Protector, Adjustable **T95-1228**

Shaft Seal Seat Installer / Remover (O.E.) **T60-3001**



## DENSO

### 6P127A, 6P127B, 6P127D

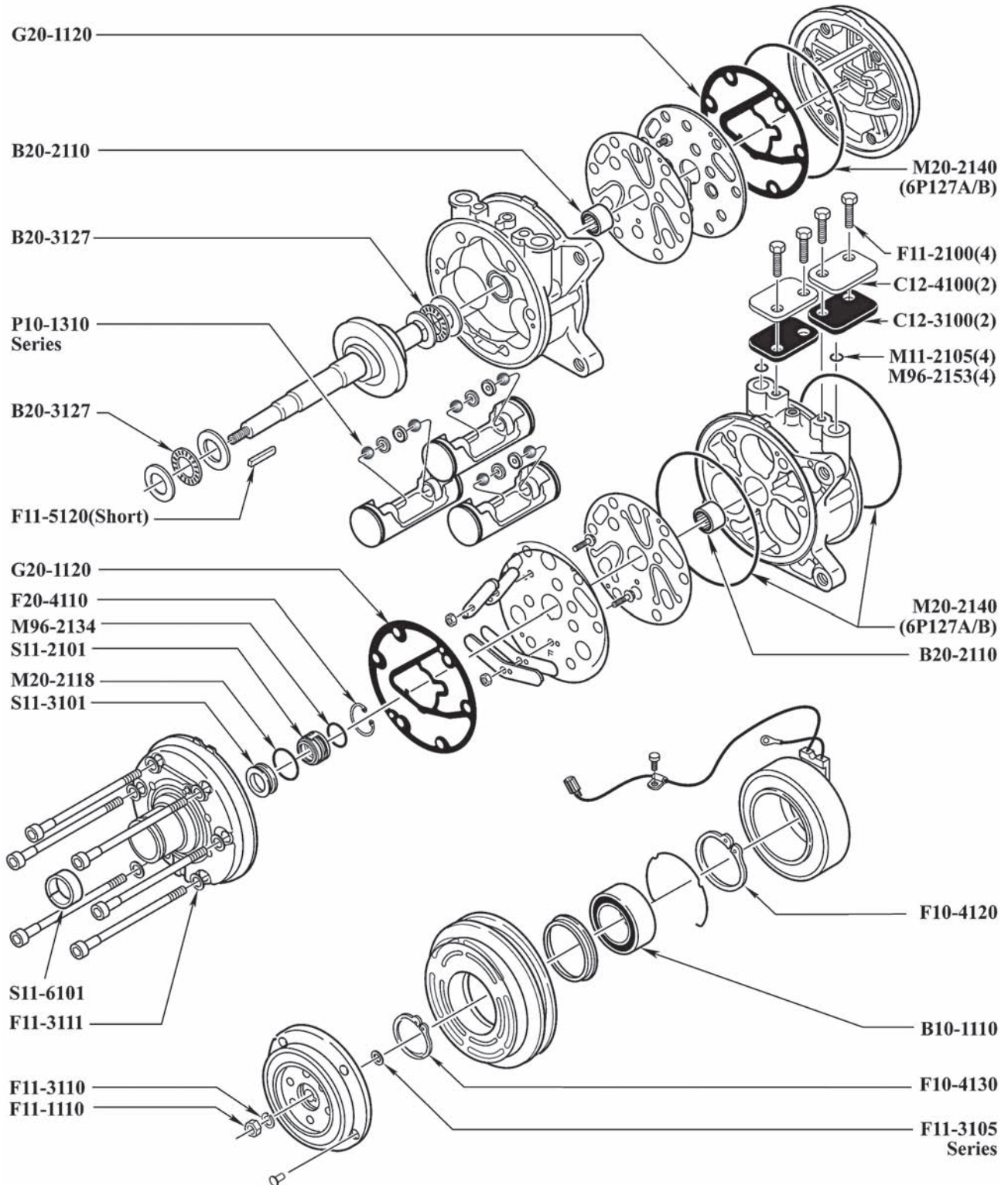

## DENSO

### 6P127A, 6P127B, 6P127D

O-Rings	R134a and R-12 Compatible	Green HNBR	Black Nitrile
Carbon Shaft Seal O-Ring		<b>M96-2134</b>	<b>M96-1034</b>
Case O-Ring		<b>M20-2140</b>	<b>M20-1040</b>
Internal Valve Plate O-Ring		<b>M20-2115</b>	<b>M20-1015</b>
Shaft Seal Seat O-Ring		<b>M20-2118</b>	<b>M20-1018</b>
Suction / Discharge Port O-Ring (Aftermarket Hose Assembly)		<b>M11-2105</b>	<b>M11-1005</b>
Suction / Discharge Port O-Ring (Factory Hose Assembly)		<b>M96-2153</b>	<b>M96-1053</b>

#### Bearings

Case Bearing (16mm x 23mm x 16mm)	<b>B20-2110</b>
Clutch Bearing (40mm x 62mm x 20.6mm-24mm)	<b>B10-1110</b>
Thrust Bearing (17mm x 34mm x 2.4mm)	<b>B20-3127</b>

#### Chemicals

Ultra PAG Oil 46 - 6pk, 8 oz Bottle	<b>MT3012</b>
Ultra PAG Oil 46 - 6pk, Quart Bottle	<b>MT3018</b>
Ultra PAG Oil 46 - Drum (52 gal)	<b>A10-6163</b>

#### Fasteners

Bolt - Shipping Plate	<b>F11-2100</b>
Helical Insert - Rear Head / Shipping Plate (8-1.25 x 12mm)	<b>F10-6211</b>
Nut - Shaft	<b>F11-1110</b>
Shaft Key (Short - 11.9mm x 4.0mm)	<b>F11-5120</b>
Retaining Ring - Coil	<b>F10-4120</b>
Retaining Ring - Pulley	<b>F10-4130</b>
Retaining Ring - Shaft Seal Seat	<b>F20-4110</b>
Lockwasher - Shaft	<b>F11-3110</b>
Shim - Clutch (0.20mm)	<b>F11-3105</b>
Shim - Clutch (0.51mm)	<b>F11-3115</b>
Washer - Head Bolt	<b>F11-3111</b>
Clutch Installation Kit	<b>K20-5010</b>

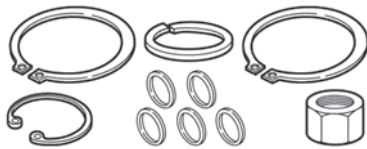

Includes: Coil Retaining Ring (0.078" - 1.198 mm Thick) (1), Coil Retaining Ring - (0.062 - 1.57 mm Thick) (1), Pully Retaining Ring (1), Shaft Locknut (1), Shaft Lockwasher (1), Hub Shim - .020" Thick (5)

#### Fasteners

Clutch Installation Kit	<b>K20-5110</b>
-------------------------	-----------------



Includes: Coil Retaining Ring (0.078" - 1.198 mm Thick) (1), Coil Retaining Ring - (0.062 - 1.57 mm Thick) (1), Pully Retaining Ring (1), Shaft Locknut (1), Shaft Lockwasher (1), Hub Shim - .020" Thick (5), Shaft Key (Long) (1), Shaft Key (Short) (1)

#### Gaskets

Gasket - Head	Fiber <b>G20-1120</b>
Gasket Kit (Fiber)	Green HNBR <b>K20-2101</b>

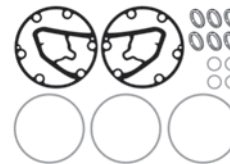

Includes: Head Bolt Washer (6), Head Gasket (Fiber) (2), Case O-Ring (3), Suction / Discharge Port O-Ring (4)

Gasket Kit (Fiber)	Black Nitrile <b>K20-2001</b>
--------------------	-------------------------------

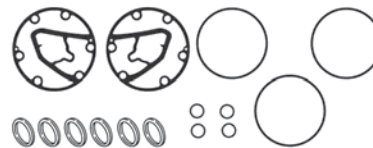

Includes: Head Bolt Washer (6), Head Gasket (Fiber) (2), Case O-Ring (3), Suction / Discharge Port O-Ring (4)

#### Piston Components

Piston Ball (13.49mm) (Standard)	<b>P10-1310</b>
Piston Ball (13.50mm) (Oversize)	<b>P10-1315</b>
Piston Ball (13.51mm) (Oversize)	<b>P10-1320</b>

#### Service Items

Fitting (Refrigerant) - 1/8" NPT Brass Port w/ Valve	<b>A10-1024</b>
--	-----------------

## DENSO

6P127A, 6P127B, 6P127D

### Shaft Seals

Carbon Shaft Seal	HNBR <b>S11-2101</b>
Felt Wiper	<b>S11-6101</b>
Felt Wiper - Wick Type	<b>S13-4101</b>
Metal Shaft Seal Seat	<b>S11-3101</b>
Carbon Shaft Seal Kit	Green HNBR <b>K20-3115</b>



*Includes: Head Bolt Washer (6), Lip Seal/Metal Shaft Seal Retaining Ring (1), Lip Seal/Metal Shaft Seal Seat O-Ring (Pre-92) (1), Carbon Shaft Seal (Pre-92) (1), Metal Shaft Seal Seat (1)*

### Shipping Closures

Cap - 1/4" Low Side	<b>C10-1000</b>
Shipping Pad (Use with C12-4100 or C12-4101)	<b>C12-3100</b>
Shipping Plate (Use with 2 C12-3100) (Covers all 4 ports)	<b>C12-4101</b>
Shipping Plate (Use with C12-3100)	<b>C12-4100</b>
Shipping Plate (Use with C95-3003 & C95-3004)	<b>C95-4001</b>
Shipping Plug (Discharge) (Use with C95-4001)	<b>C95-3003</b>
Shipping Plug (Suction) (Use with C95-4001)	<b>C95-3004</b>

### Tools

Helical Insert Drill for 8-1.25mm Inserts	<b>T10-6053</b>
Helical Insert Tap 8-1.25mm	<b>T10-6254</b>
Helical Insert Tool 8-1.25mm - Bolt Style	<b>T10-6554</b>
Shaft Seal Installer / Remover (Aftermarket)	<b>T20-3002</b>
Shaft Seal Protector	<b>T11-1000</b>
Shaft Seal Protector, Adjustable	<b>T95-1228</b>
Shaft Seal Seat Installer / Remover (O.E.)	<b>T60-3001</b>
Helical Insert Repair Kit (8-1.25mm)	<b>K10-1180</b>



*Includes: Helical Inserts (25), Drill (1), Tap (1), Installation Tool - Bolt Style (1)*





## DENSO

### 6P134

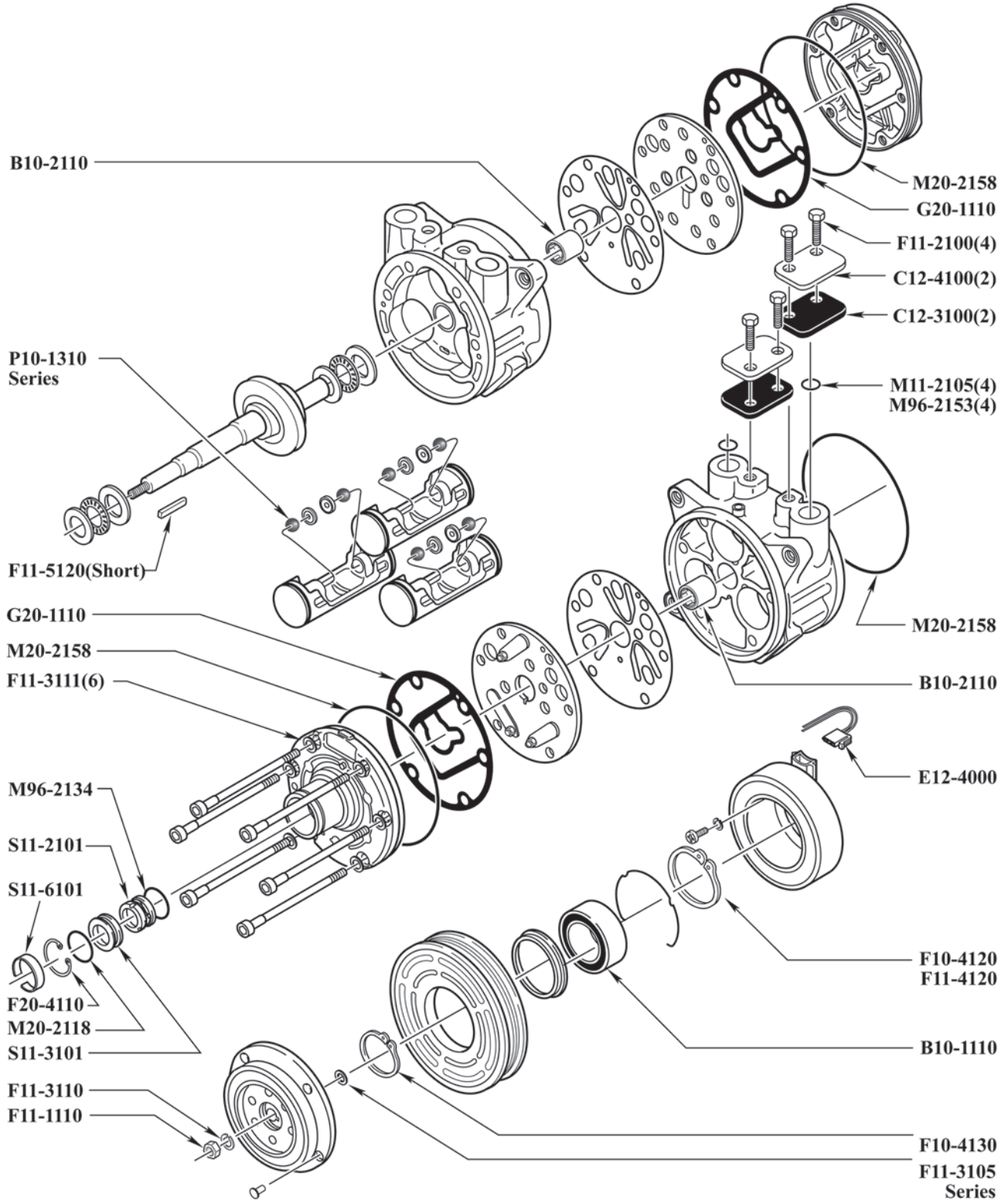

## DENSO

### 6P134

O-Rings	R134a and R-12 Compatible	Green HNBR	Black Nitrile
Carbon Shaft Seal O-Ring		<b>M96-2134</b>	<b>M96-1034</b>
Case O-Ring		<b>M20-2158</b>	<b>M20-1058</b>
Shaft Seal Seat O-Ring		<b>M20-2118</b>	<b>M20-1018</b>
Suction / Discharge Port O-Ring (Aftermarket Hose Assembly)		<b>M11-2105</b>	<b>M11-1005</b>
Suction / Discharge Port O-Ring (Factory Hose Assembly)		<b>M96-2153</b>	<b>M96-1053</b>

#### Bearings

Case Bearing (16mm x 23mm x 21.9mm)	<b>B10-2110</b>
Clutch Bearing (40mm x 62mm x 20.6mm-24mm)	<b>B10-1110</b>

#### Chemicals

Ultra PAG Oil 46 - 6pk, 8 oz Bottle	<b>MT3012</b>
Ultra PAG Oil 46 - 6pk, Quart Bottle	<b>MT3018</b>
Ultra PAG Oil 46 - Drum (52 gal)	<b>A10-6163</b>

#### Electrical

Clutch Coil Pigtail	<b>E12-4000</b>
---------------------	-----------------

#### Fasteners

Bolt - Shipping Plate	<b>F11-2100</b>
Helical Insert - Rear Head / Shipping Plate (8-1.25 x 12mm)	<b>F10-6211</b>
Nut - Shaft	<b>F11-1110</b>
Shaft Key (Short - 11.9mm x 4.0mm)	<b>F11-5120</b>
Retaining Ring - Coil (1.57mm)	<b>F11-4120</b>
Retaining Ring - Coil (1.98mm)	<b>F10-4120</b>
Retaining Ring - Pulley	<b>F10-4130</b>
Retaining Ring - Shaft Seal Seat	<b>F20-4110</b>
Lockwasher - Shaft	<b>F11-3110</b>
Shim - Clutch (0.20mm)	<b>F11-3105</b>
Shim - Clutch (0.51mm)	<b>F11-3115</b>
Washer - Head Bolt	<b>F11-3111</b>
Clutch Installation Kit	<b>K20-5010</b>

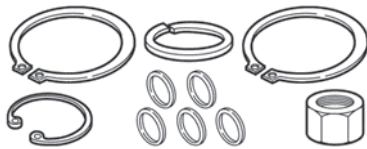

Includes: Coil Retaining Ring (0.078" - 1.198 mm Thick) (1), Coil Retaining Ring - (0.062 - 1.57 mm Thick) (1), Pulley Retaining Ring (1), Shaft Locknut (1), Shaft Lockwasher (1), Hub Shim - .020" Thick (5)

#### Fasteners

Clutch Installation Kit	<b>K20-5110</b>
-------------------------	-----------------



Includes: Coil Retaining Ring (0.078" - 1.198 mm Thick) (1), Coil Retaining Ring - (0.062 - 1.57 mm Thick) (1), Pulley Retaining Ring (1), Shaft Locknut (1), Shaft Lockwasher (1), Hub Shim - .020" Thick (5), Shaft Key (Long) (1), Shaft Key (Short) (1)

#### Gaskets

Gasket - Head	Fiber <b>G20-1110</b>
Gasket Kit (Metal)	Green HNBR <b>K20-2115</b>

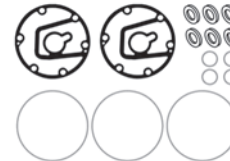

Includes: Head Bolt Washer (6), Head Gasket (2), Case O-Ring (3), Suction / Discharge Port O-Ring (4)

Gasket Kit (Metal)	Black Nitrile <b>K20-2015</b>
--------------------	-------------------------------

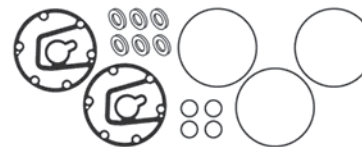

Includes: Head Bolt Washer (6), Head Gasket (Metal) (2), Case O-Ring (3), Suction/Discharge Port O-Ring (4).

#### Piston Components

Piston Ball (13.49mm) (Standard)	<b>P10-1310</b>
Piston Ball (13.50mm) (Oversize)	<b>P10-1315</b>
Piston Ball (13.51mm) (Oversize)	<b>P10-1320</b>

#### Service Items

Fitting (Refrigerant) - 1/8" NPT Brass Port w/ Valve	<b>A10-1024</b>
--	-----------------

#### Shaft Seals

Carbon Shaft Seal	<b>HNBR S11-2101</b>
-------------------	----------------------

## DENSO

6P134

### Shaft Seals

Felt Wiper	<b>S11-6101</b>
Felt Wiper - Wick Type	<b>S13-4101</b>
Metal Shaft Seal Seat	<b>S11-3101</b>
Carbon Shaft Seal Kit	Green HNBR <b>K20-3115</b>



*Includes: Head Bolt Washer (6), Lip Seal/Metal Shaft Seal Retaining Ring (1), Lip Seal/Metal Shaft Seal Seat O-Ring (Pre-92) (1), Carbon Shaft Seal (Pre-92) (1), Metal Shaft Seal Seat (1)*

### Shipping Closures

Cap - 1/4" Low Side	<b>C10-1000</b>
Shipping Pad (Use with C12-4100 or C12-4101)	<b>C12-3100</b>
Shipping Plate (Use with 2 C12-3100) (Covers all 4 ports)	<b>C12-4101</b>
Shipping Plate (Use with C12-3100)	<b>C12-4100</b>
Shipping Plate (Use with C95-3003 & C95-3004)	<b>C95-4001</b>
Shipping Plug (Discharge) (Use with C95-4001)	<b>C95-3003</b>
Shipping Plug (Suction) (Use with C95-4001)	<b>C95-3004</b>

### Tools

Helical Insert Drill for 8-1.25mm Inserts	<b>T10-6053</b>
Helical Insert Tap 8-1.25mm	<b>T10-6254</b>
Helical Insert Tool 8-1.25mm - Bolt Style	<b>T10-6554</b>
Shaft Seal Installer / Remover (Aftermarket)	<b>T20-3002</b>
Shaft Seal Protector	<b>T11-1000</b>
Shaft Seal Protector, Adjustable	<b>T95-1228</b>
Shaft Seal Seat Installer / Remover (O.E.)	<b>T60-3001</b>
Helical Insert Repair Kit (8-1.25mm)	<b>K10-1180</b>



*Includes: Helical Inserts (25), Drill (1), Tap (1), Installation Tool - Bolt Style (1)*



## DENSO

6P148, 6P148A, 6P148C

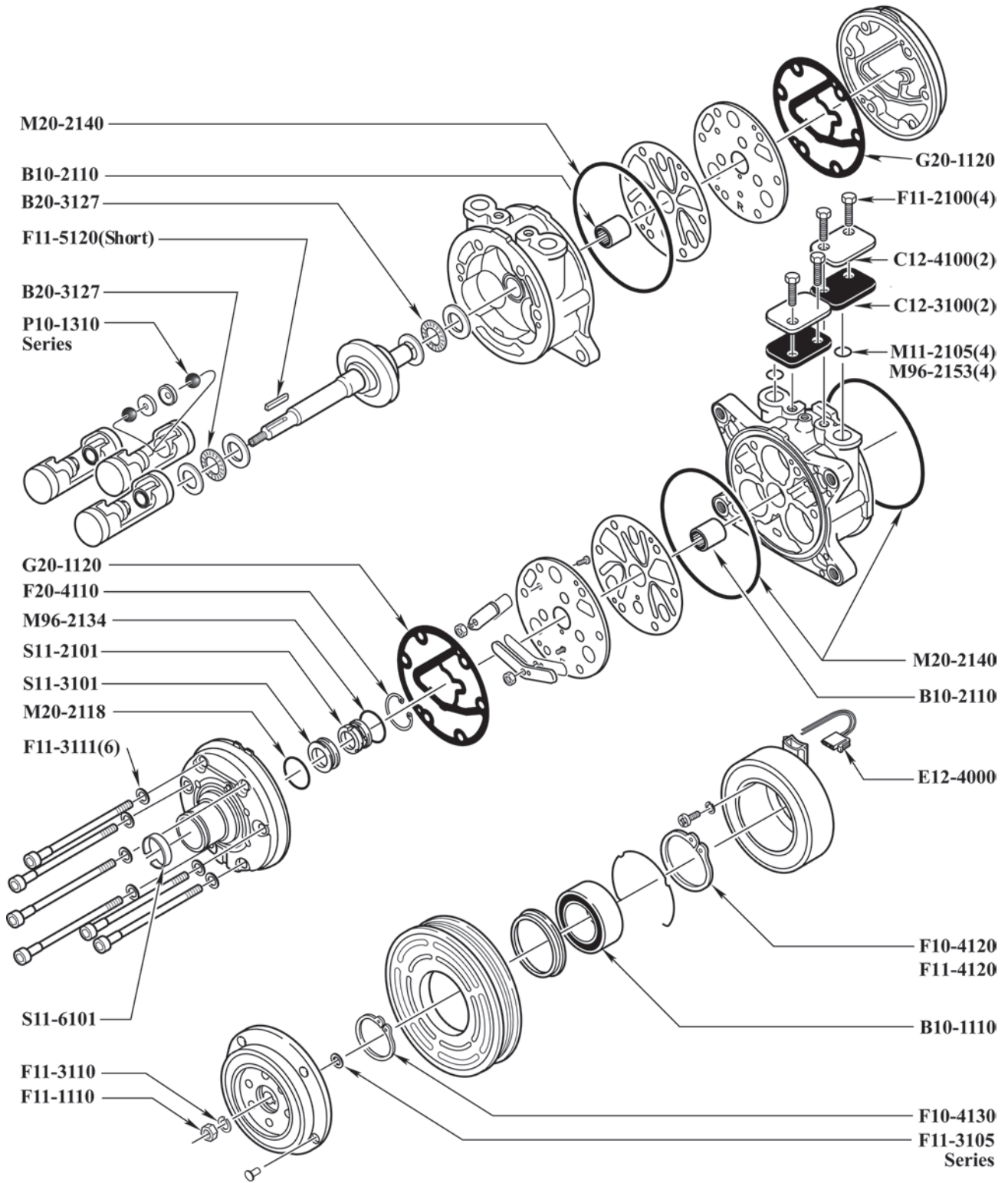

## DENSO

### 6P148, 6P148A, 6P148C

O-Rings	R134a and R-12 Compatible	Green HNBR	Black Nitrile
Carbon Shaft Seal O-Ring		<b>M96-2134</b>	<b>M96-1034</b>
Case O-Ring		<b>M20-2140</b>	<b>M20-1040</b>
Shaft Seal Seat O-Ring		<b>M20-2118</b>	<b>M20-1018</b>
Suction / Discharge Port O-Ring (Aftermarket Hose Assembly)		<b>M11-2105</b>	<b>M11-1005</b>
Suction / Discharge Port O-Ring (Factory Hose Assembly)		<b>M96-2153</b>	<b>M96-1053</b>

Bearings	
Case Bearing (16mm x 23mm x 21.9mm)	<b>B10-2110</b>
Clutch Bearing (40mm x 62mm x 20.6mm-24mm)	<b>B10-1110</b>
Thrust Bearing (17mm x 34mm x 2.4mm)	<b>B20-3127</b>

Chemicals	
Ultra PAG Oil 46 - 6pk, 8 oz Bottle	<b>MT3012</b>
Ultra PAG Oil 46 - 6pk, Quart Bottle	<b>MT3018</b>
Ultra PAG Oil 46 - Drum (52 gal)	<b>A10-6163</b>

Electrical	
Clutch Coil Pigtail	<b>E12-4000</b>

Fasteners	
Bolt - Shipping Plate	<b>F11-2100</b>
Helical Insert - Rear Head / Shipping Plate (8-1.25 x 12mm)	<b>F10-6211</b>
Nut - Shaft	<b>F11-1110</b>
Shaft Key (Short - 11.9mm x 4.0mm)	<b>F11-5120</b>
Retaining Ring - Coil (1.57mm)	<b>F11-4120</b>
Retaining Ring - Coil (1.98mm)	<b>F10-4120</b>
Retaining Ring - Pulley	<b>F10-4130</b>
Retaining Ring - Shaft Seal Seat	<b>F20-4110</b>
Lockwasher - Shaft	<b>F11-3110</b>
Shim - Clutch (0.20mm)	<b>F11-3105</b>
Shim - Clutch (0.51mm)	<b>F11-3115</b>
Washer - Head Bolt	<b>F11-3111</b>
Clutch Installation Kit	<b>K20-5010</b>



Includes: Coil Retaining Ring (0.078" - 1.198 mm Thick) (1), Coil Retaining Ring - (0.062 - 1.57 mm Thick) (1), Pulley Retaining Ring (1), Shaft Locknut (1), Shaft Lockwasher (1), Hub Shim - .020" Thick (5)

Fasteners	
Clutch Installation Kit	<b>K20-5110</b>



Includes: Coil Retaining Ring (0.078" - 1.198 mm Thick) (1), Coil Retaining Ring - (0.062 - 1.57 mm Thick) (1), Pulley Retaining Ring (1), Shaft Locknut (1), Shaft Lockwasher (1), Hub Shim - .020" Thick (5), Shaft Key (Long) (1), Shaft Key (Short) (1)

Gaskets	
Gasket - Head	Fiber <b>G20-1120</b>
Gasket Kit (Fiber)	Green HNBR <b>K20-2101</b>

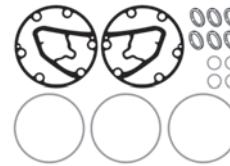

Includes: Head Bolt Washer (6), Head Gasket (Fiber) (2), Case O-Ring (3), Suction / Discharge Port O-Ring (4)

Gasket Kit (Fiber)	Black Nitrile <b>K20-2001</b>
--------------------	-------------------------------

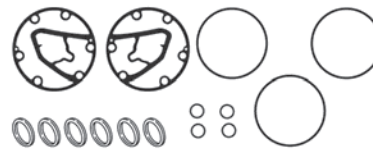

Includes: Head Bolt Washer (6), Head Gasket (Fiber) (2), Case O-Ring (3), Suction / Discharge Port O-Ring (4)

Piston Components	
Piston Ball (13.49mm) (Standard)	<b>P10-1310</b>
Piston Ball (13.50mm) (Oversize)	<b>P10-1315</b>
Piston Ball (13.51mm) (Oversize)	<b>P10-1320</b>

Service Items	
Fitting (Refrigerant) - 1/8" NPT Brass Port w/ Valve	<b>A10-1024</b>

Shaft Seals	
Carbon Shaft Seal	HNBR <b>S11-2101</b>

## DENSO

6P148, 6P148A, 6P148C

### Shaft Seals

Felt Wiper	<b>S11-6101</b>
Felt Wiper - Wick Type	<b>S13-4101</b>
Metal Shaft Seal Seat	<b>S11-3101</b>
Carbon Shaft Seal Kit	Green HNBR <b>K20-3115</b>



*Includes: Head Bolt Washer (6), Lip Seal/Metal Shaft Seal Retaining Ring (1), Lip Seal/Metal Shaft Seal Seat O-Ring (Pre-92) (1), Carbon Shaft Seal (Pre-92) (1), Metal Shaft Seal Seat (1)*

### Shipping Closures

Shipping Pad (Use with C12-4100 or C12-4101)	<b>C12-3100</b>
Shipping Plate (Use with 2 C12-3100) (Covers all 4 ports)	<b>C12-4101</b>
Shipping Plate (Use with C12-3100)	<b>C12-4100</b>
Shipping Plate (Use with C95-3003 & C95-3004)	<b>C95-4001</b>
Shipping Plug (Discharge) (Use with C95-4001)	<b>C95-3003</b>
Shipping Plug (Suction) (Use with C95-4001)	<b>C95-3004</b>

### Tools

Helical Insert Drill for 8-1.25mm Inserts	<b>T10-6053</b>
Helical Insert Tap 8-1.25mm	<b>T10-6254</b>
Helical Insert Tool 8-1.25mm - Bolt Style	<b>T10-6554</b>
Shaft Seal Installer / Remover (Aftermarket)	<b>T20-3002</b>
Shaft Seal Protector, Adjustable	<b>T95-1228</b>
Shaft Seal Seat Installer / Remover (O.E.)	<b>T60-3001</b>
Helical Insert Repair Kit (8-1.25mm)	<b>K10-1180</b>



*Includes: Helical Inserts (25), Drill (1), Tap (1), Installation Tool - Bolt Style (1)*





## DENSO 6SEU12

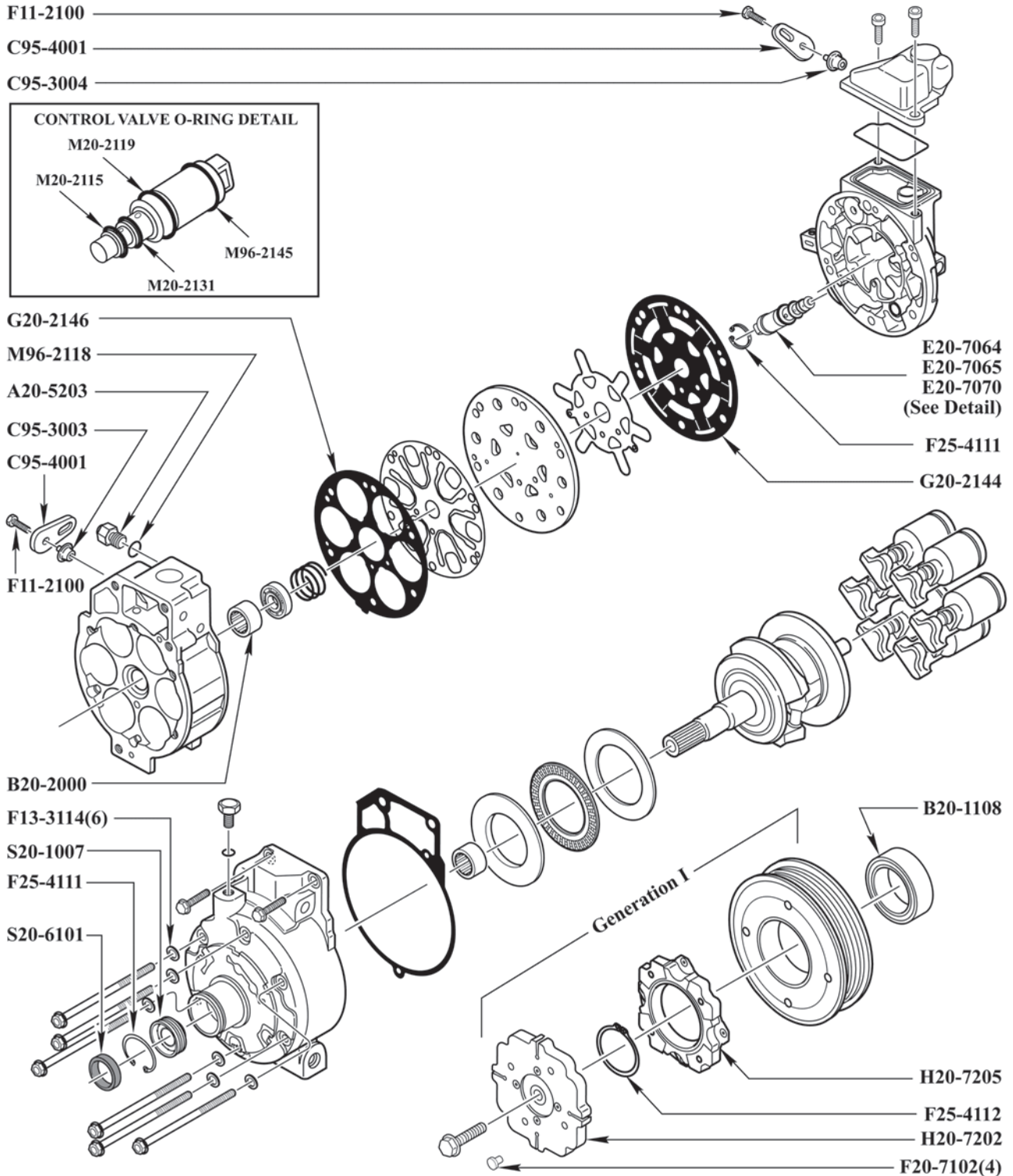

## DENSO

### 6SEU12

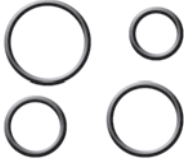
O-Rings	R134a and R-12 Compatible	Green HNBR	Black Nitrile
Control Valve Inner Center O-Ring		<b>M20-2131</b>	
Control Valve Inner O-Ring		<b>M20-2115</b>	<b>M20-1015</b>
Control Valve Outer Center O-Ring		<b>M20-2119</b>	
Control Valve Outer O-Ring		<b>M96-2145</b>	
High Pressure Relief Valve O-Ring		<b>M96-2118</b>	<b>M96-1018</b>
<b>Bearings</b>			
Case Bearing (Rear) (15mm x 23mm x 16mm Hardened)	<b>B20-2000</b>		
Clutch Bearing (35mm x 52mm x 22mm)	<b>B20-1108</b>		
<b>Chemicals</b>			
Ultra PAG Oil 46 - 6pk, 8 oz Bottle	<b>MT3012</b>		
Ultra PAG Oil 46 - 6pk, Quart Bottle	<b>MT3018</b>		
Ultra PAG Oil 46 - Drum (52 gal)	<b>A10-6163</b>		
<b>Clutch Components</b>			
Generation I Metal Pulley Assembly	<b>H20-7961</b>		
Generation I Metal Pulley Assembly	<b>H20-7962</b>		
Generation I Metal Pulley Assembly	<b>H20-7963</b>		
Generation I Direct Drive Hub	<b>H20-7205</b>		
Generation I Direct Drive Hub Cover	<b>H20-7202</b>		
Generation I Splined Drive Shaft	<b>H20-7950</b>		
Generation II Direct Drive Hub	<b>H20-7203</b>		
Generation II Direct Drive Hub Rubber Damper	<b>H20-7204</b>		
Generation II Hub Metal Retaining Ring	<b>H20-7208</b>		
Generation III Direct Drive Hub	<b>H20-7206</b>		
Generation III Direct Drive Hub Rubber Damper	<b>H20-7207</b>		
Generation I Metal Pulley - 6 Groove - Total OD: 110 mm	<b>H20-7841</b>		
Generation III Metal Pulley - 6 Groove - Total OD: 105 mm	<b>H20-7860</b>		
<b>Control Valves</b>			
Connector for Electronic Control Valves	<b>E20-4010</b>		
Control Valve (90° Terminal - Long Connector - No Diode)	<b>E20-7070</b>		
Control Valve (90° Terminal - No Diode)	<b>E20-7064</b>		
Control Valve (90° Terminal w/ Diode) (Mercedes & BMW)	<b>E20-7065</b>		
<b>Control Valves</b>			
Control Valve Kit (No Diode)		Electronic	<b>K20-2174</b>
			
<i>Replaces:</i> <i>E20-7000, E20-7001, E20-7002, E20-7003, E20-7004, E20-7005, E20-7006, E20-7007, E20-7008, E20-7009, E20-7018, E20-7019</i>			
<b>O-Ring Kit, Control Valve (4 O-Rings)</b>			
		Green HNBR	<b>K20-2166</b>
			
<i>Includes: Gaskets: Control Valve O-Rings (4).</i>			
<b>Fasteners</b>			
Bolt - Shipping Plate			<b>F11-2100</b>
Denso constant drive hub and pulley assembly rivet			<b>F20-7102</b>
Helical Insert - Rear Head / Shipping Plate (8-1.25 x 12mm)			<b>F10-6211</b>
Retaining Ring - Lip Seal / Control Valve			<b>F25-4111</b>
Retaining Ring - Pulley			<b>F25-4112</b>
Washer - Head Bolt			<b>F13-3114</b>
<b>Gaskets</b>			
Gasket - Cylinder		Metal	<b>G20-2146</b>
Gasket - Rear Head		Metal	<b>G20-2144</b>
<b>Service Items</b>			
High Pressure Relief Valve			<b>A20-5203</b>
<b>Shaft Seals</b>			
Felt Wiper			<b>S20-6101</b>
Lip Seal (Black Rubber Coated)		HNBR	<b>S20-1007</b>

## DENSO

### 6SEU12

#### Shaft Seals

Lip Seal Kit

Green HNBR **K20-3100**



*Includes: Shaft Seal Retaining Ring (1), Lip Seal (1)*

Lip Seal Kit

Green HNBR **K20-3149**



*Includes: Retaining Ring (1), Lip Seal (1), Felt Wiper (1)*

#### Shipping Closures

Shipping Plate (Use with C95-3003 & C95-3004) **C95-4001**

Shipping Plug (Discharge) (Use with C95-4001) **C95-3003**

Shipping Plug (Suction) (Use with C95-4001) **C95-3004**

#### Tools

Direct Drive Hub Remover **T20-3004**

Helical Insert Drill for 8-1.25mm Inserts **T10-6053**

Helical Insert Tap 8-1.25mm **T10-6254**

Helical Insert Tool 8-1.25mm - Bolt Style **T10-6554**

Shaft Seal Protector, Adjustable **T95-1228**

Helical Insert Repair Kit (8-1.25mm) **K10-1180**



*Includes: Helical Inserts (25), Drill (1), Tap (1), Installation Tool - Bolt Style (1)*



## DENSO

### 6SEU12C, 6SEU14C

O-Rings	R134a and R-12 Compatible	Green HNBR	Black Nitrile
Control Valve Inner Middle O-Ring		<b>M20-2131</b>	
Control Valve Inner O-Ring		<b>M20-2115</b>	<b>M20-1015</b>
Control Valve Outer Middle O-Ring		<b>M20-2119</b>	
Control Valve Outer O-Ring		<b>M96-2145</b>	
High Pressure Relief Valve O-Ring		<b>M96-2118</b>	<b>M96-1018</b>

Bearings	
Clutch Bearing (35mm x 52mm x 22mm)	<b>B20-1108</b>

Chemicals	
Ultra PAG Oil 46 - 6pk, 8 oz Bottle	<b>MT3012</b>
Ultra PAG Oil 46 - 6pk, Quart Bottle	<b>MT3018</b>
Ultra PAG Oil 46 - Drum (52 gal)	<b>A10-6163</b>

Clutch Components	
Generation I Metal Pulley Assembly	<b>H20-7961</b>
Generation I Metal Pulley Assembly	<b>H20-7962</b>
Generation I Metal Pulley Assembly	<b>H20-7963</b>
Generation I Direct Drive Hub	<b>H20-7205</b>
Generation I Direct Drive Hub Cover	<b>H20-7202</b>
Generation I Splined Drive Shaft	<b>H20-7950</b>
Generation II Direct Drive Hub	<b>H20-7203</b>
Generation II Direct Drive Hub Rubber Damper	<b>H20-7204</b>
Generation II Hub Metal Retaining Ring	<b>H20-7208</b>
Generation III Direct Drive Hub	<b>H20-7206</b>
Generation III Direct Drive Hub Rubber Damper	<b>H20-7207</b>
Generation I Metal Pulley - 6 Groove - Total OD: 110 mm	<b>H20-7841</b>
Generation III Metal Pulley - 6 Groove - Total OD: 105 mm	<b>H20-7860</b>
Generation III Metal Pulley - 6 Groove - Total OD: 120 mm	<b>H20-7870</b>

Control Valves	
Connector for Electronic Control Valves	<b>E20-4010</b>
Control Valve (90° Terminal)	<b>E20-7064</b>
Control Valve Kit	Electronic <b>K20-2174</b>



Replaces:  
E20-7000, E20-7001, E20-7002, E20-7003, E20-7004, E20-7005,  
E20-7006, E20-7007, E20-7008, E20-7009, E20-7018, E20-7019

Control Valves	
O-Ring Kit, Control Valve (4 O-Rings)	Green HNBR <b>K20-2166</b>



Includes: Gaskets: Control Valve O-Rings (4).

Fasteners	
Bolt - Shaft	<b>F20-2110</b>
Bolt - Shipping Plate	<b>F45-2101</b>
Rivet - Generation I Direct Drive Hub	<b>F20-7102</b>
Retaining Ring - Lip Seal / Control Valve	<b>F25-4111</b>
Retaining Ring - Pulley	<b>F25-4112</b>
Washer - Head Bolt	<b>F13-3114</b>

Gaskets	
Gasket - Cylinder	Metal <b>G20-2146</b>
Gasket - Front Head	Metal <b>G20-2145</b>
Gasket - Rear Head	Metal <b>G20-2144</b>
Gasket - Discharge Housing	Green HNBR <b>G20-3116</b>
Gasket Kit (Metal)	Green HNBR <b>K20-2132</b>

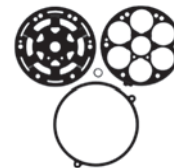

Includes: Cylinder Gasket (1), Valve Plate Gasket (1), Front Head Gasket (1), Pressure Relief Valve O-Ring (1).

Service Items	
High Pressure Relief Valve	<b>A20-5203</b>

Shaft Seals	
Felt Wiper	<b>S20-6101</b>
Lip Seal (Black Rubber Coated)	HNBR <b>S20-1007</b>

## DENSO

6SEU12C, 6SEU14C

### Shaft Seals

Lip Seal Kit

Green HNBR **K20-3149**



*Includes: Retaining Ring (1), Lip Seal (1), Felt Wiper (1)*

### Shipping Closures

Shipping Plate (Use with C95-3003 & C95-3005) **C95-4002**

Shipping Plug (Discharge) (Use with C95-4002) **C95-3003**

Shipping Plug (Suction) (Use with C95-4002) **C95-3005**

### Tools

Shaft Seal Protector, Adjustable **T95-1229**

## DENSO 6SEU16, 6SEU16C

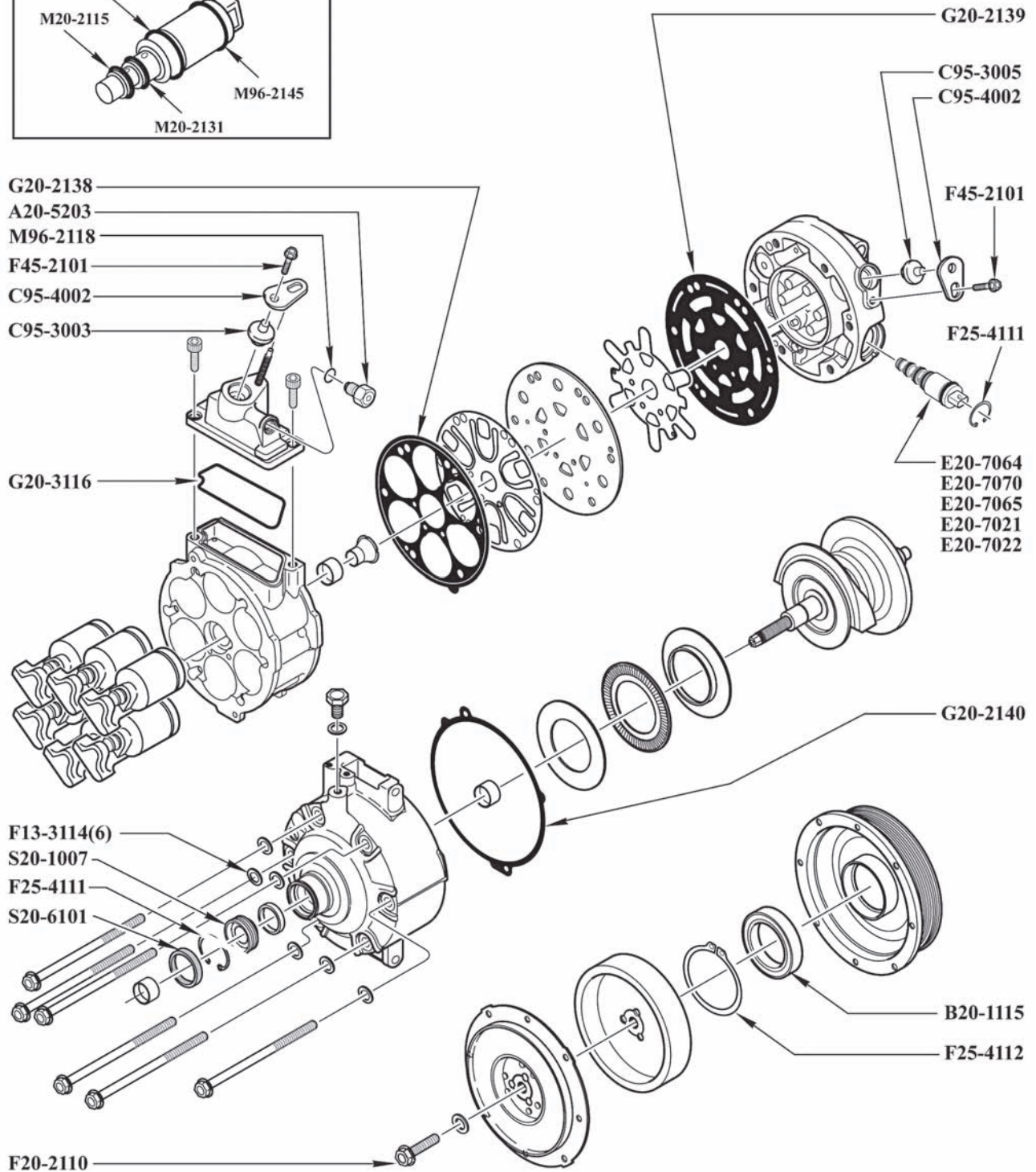
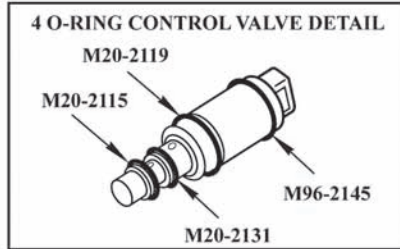



## DENSO

### 6SEU16, 6SEU16C

O-Rings	R134a and R-12 Compatible	Green HNBR	Black Nitrile
Control Valve (4 O-Ring) Inner Middle O-Ring		<b>M20-2131</b>	
Control Valve (4 O-Ring) Inner O-Ring		<b>M20-2115</b>	<b>M20-1015</b>
Control Valve (4 O-Ring) Outer Middle O-Ring		<b>M20-2119</b>	
Control Valve (4 O-Ring) Outer O-Ring		<b>M96-2145</b>	
Control Valve (7 O-Ring) O-Ring 1 (Inner / Smallest)		<b>M96-2131</b>	
Control Valve (7 O-Ring) O-Ring 2		<b>M96-2132</b>	<b>M96-1032</b>
Control Valve (7 O-Ring) O-Ring 3		<b>M96-2137</b>	<b>M96-1037</b>
Control Valve (7 O-Ring) O-Ring 4		<b>M65-2106</b>	<b>M65-1006</b>
Control Valve (7 O-Ring) O-Ring 5		<b>M20-2133</b>	
Control Valve (7 O-Ring) O-Ring 6		<b>M95-2107</b>	<b>M95-1007</b>
Control Valve (7 O-Ring) O-Ring 7 (Outer / Largest)		<b>M96-2149</b>	
High Pressure Relief Valve O-Ring		<b>M96-2118</b>	<b>M96-1018</b>

#### Bearings

Clutch Bearing (35mm x 52mm x 12mm) **B20-1115**

#### Chemicals

Ultra PAG Oil 46 - 6pk, 8 oz Bottle **MT3012**

Ultra PAG Oil 46 - 6pk, Quart Bottle **MT3018**

Ultra PAG Oil 46 - Drum (52 gal) **A10-6163**

#### Clutch Components

Generation I Metal Pulley Assembly **H20-7965**

Direct Drive Hub (Toyota Camry 2007-) **H20-7220**

Generation II Direct Drive Hub **H20-7203**

Generation II Direct Drive Hub Rubber Damper **H20-7204**

Generation II Hub Metal Retaining Ring **H20-7208**

#### Control Valves

Connector for Electronic Control Valves **E20-4010**

Control Valve (4 O-Ring - 90° Term w/ Diode)(Mercedes & BMW) **E20-7065**

Control Valve (4 O-Ring - 90° Terminal - Long Connector - No Diode) **E20-7070**

Control Valve (4 O-Ring - 90° Terminal - No Diode) **E20-7064**

Control Valve (extended connector) **E20-7074**

Main Control Valve **A20-5070**

Control Valve Kit (4 O-Ring - No Diode) Electronic **K20-2174**



Replaces:

E20-7000, E20-7001, E20-7002, E20-7003, E20-7004, E20-7005, E20-7006, E20-7007, E20-7008, E20-7009, E20-7018, E20-7019

#### Control Valves

O-Ring Kit, Control Valve (4 O-Rings) Green HNBR **K20-2166**



Includes: Gaskets: Control Valve O-Rings (4).

O-Ring Kit, Control Valve (7 O-Rings) Green HNBR **K20-2180**



Includes all 7 o-rings needed to reseal the shaft of the control valve. For both straight and 90 degree connection valves (E20-7021 and E20-7022)

#### Fasteners

Bolt - Shaft **F20-2110**

Bolt - Shipping Plate **F45-2101**

Retaining Ring - Lip Seal / Control Valve **F25-4111**

Retaining Ring - Pulley **F25-4112**

Washer - Head Bolt **F13-3114**

#### Gaskets

Gasket - Cylinder Metal **G20-2138**

Gasket - Front Head Metal **G20-2140**

Gasket - Rear Head Metal **G20-2139**

Gasket - Discharge Housing Green HNBR **G20-3116**

## DENSO

6SEU16, 6SEU16C

### Service Items

High Pressure Relief Valve **A20-5203**

### Shaft Seals

Felt Wiper **S20-6101**

Lip Seal (Black Rubber Coated) **HNBR S20-1007**

Lip Seal Kit **Green HNBR K20-3149**



*Includes: Retaining Ring (1), Lip Seal (1), Felt Wiper (1)*

### Shipping Closures

Shipping Plate (Use with C95-3003 & C95-3005) **C95-4002**

Shipping Plug (Discharge) (Use with C95-4002) **C95-3003**

Shipping Plug (Suction) (Use with C95-4002) **C95-3005**

### Tools

Direct Drive Hub Remover **T20-3004**

Shaft Seal Protector, Adjustable **T95-1229**



## DENSO 7SB16C

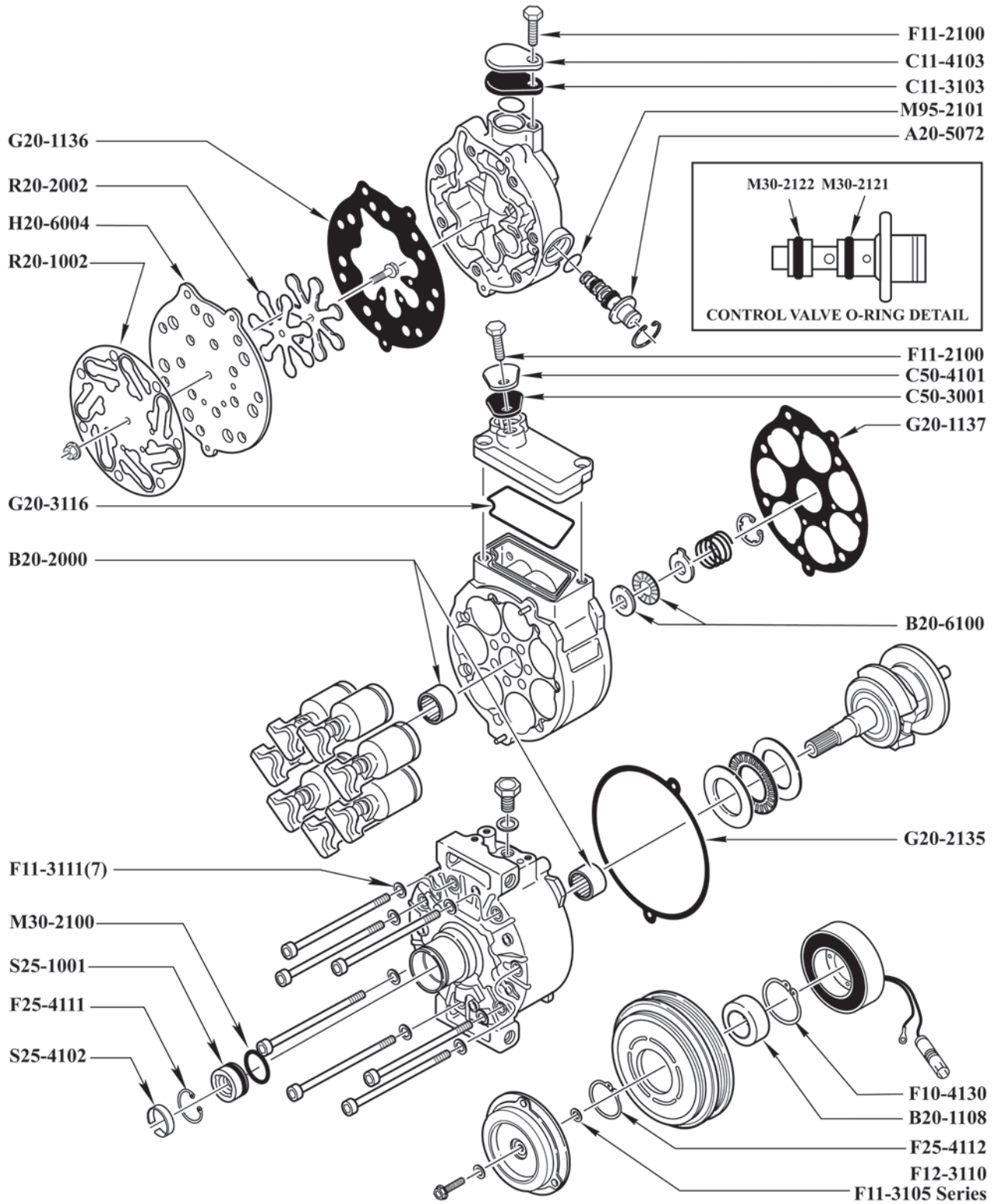

## DENSO

### 7SB16C

O-Rings	R134a and R-12 Compatible	Green HNBR	Black Nitrile
Control Valve Inner O-Ring		<b>M30-2122</b>	
Control Valve Outer O-Ring		<b>M30-2121</b>	
Control Valve Seat O-Ring		<b>M95-2101</b>	<b>M95-1001</b>
Lip Seal O-Ring		<b>M30-2100</b>	<b>M30-1000</b>
<b>Bearings</b>		<b>Reeds and Valve Plates</b>	
Case Bearing (15mm x 23mm x 16mm Hardened)	<b>B20-2000</b>	Valve Plate	<b>H20-6004</b>
Clutch Bearing (35mm x 52mm x 22mm)	<b>B20-1108</b>	Reed - Discharge Valve	<b>R20-2002</b>
Bearing Pack	<b>B20-6100</b>	Reed - Suction Valve	<b>R20-1002</b>
<b>Chemicals</b>		<b>Shaft Seals</b>	
Ultra PAG Oil 46 - 6pk, 8 oz Bottle	<b>MT3012</b>	Felt Ring	<b>S25-4102</b>
Ultra PAG Oil 46 - 6pk, Quart Bottle	<b>MT3018</b>	Lip Seal	HNBR <b>S25-1001</b>
Ultra PAG Oil 46 - Drum (52 gal)	<b>A10-6163</b>	Lip Seal Kit	Black Nitrile <b>K25-3156</b>
<b>Control Valves</b>			
Control Valve Filter	<b>A20-5121</b>		
Control Valve, Early	<b>A20-5072</b>		
<b>Fasteners</b>		<b>Shipping Closures</b>	
Bolt - Shipping Plate	<b>F11-2100</b>	Shipping Pad (Discharge) (Use with C50-4101)	<b>C50-3001</b>
Helical Insert - Rear Head / Shipping Plate (8-1.25 x 12mm)	<b>F10-6211</b>	Shipping Pad (Suction) (Use with C11-4103)	<b>C11-3103</b>
Retaining Ring - Clutch Pulley	<b>F25-4112</b>	Shipping Plate (Discharge) (Use with C50-3001)	<b>C50-4101</b>
Retaining Ring - Coil	<b>F10-4130</b>	Shipping Plate (Suction) (Use with C11-3103)	<b>C11-4103</b>
Retaining Ring - Lip Seal	<b>F25-4111</b>	<b>Tools</b>	
Shim - Clutch (0.20mm)	<b>F11-3105</b>	Shaft Seal Protector	<b>T11-1000</b>
Shim - Clutch (0.38mm)	<b>F12-3110</b>	Shaft Seal Protector, Adjustable	<b>T95-1227</b>
Shim - Clutch (0.51mm)	<b>F11-3115</b>		
Washer - Head Bolt	<b>F11-3111</b>		
<b>Gaskets</b>			
Gasket - Cylinder	Fiber <b>G20-1137</b>		
Gasket - Front Head	Fiber <b>G20-1135</b>		
Gasket - Rear Head	Fiber <b>G20-1136</b>		
Gasket - Front Head	Metal <b>G20-2135</b>		
Gasket - Discharge Housing	Green HNBR <b>G20-3116</b>		
Gasket Kit (Fiber)	Green HNBR <b>K20-2156</b>		



Includes: Front Head Gasket (1), Rear Head Gasket (1), Cylinder Gasket (1), Discharge Housing Gasket (1), Control Valve O-Ring (Inner)(1), Control Valve O-Ring (Outer )(1), Control Valve O-Ring (Intermediate) (1).





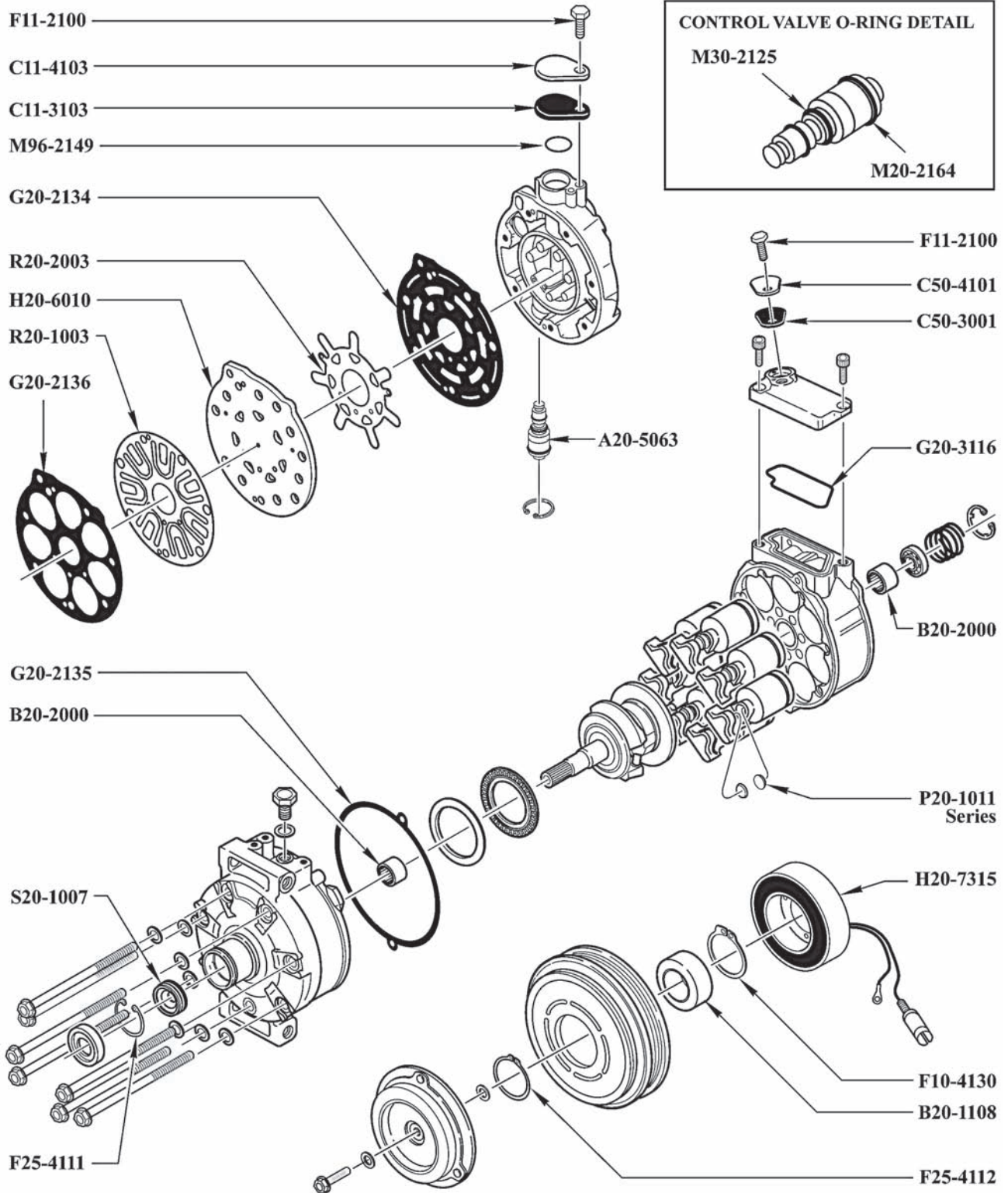

## DENSO 7SBU16C





## DENSO

### 7SBU16C

O-Rings	R134a and R-12 Compatible	Green HNBR	Black Nitrile
Control Valve Inner O-Ring		<b>M96-2171</b>	
Control Valve Middle O-Ring		<b>M96-2155</b>	
Control Valve Outer O-Ring		<b>M20-2164</b>	
Suction Port O-Ring		<b>M96-2149</b>	
<b>Bearings</b>		<b>Piston Components</b>	
Case Bearing (15mm x 23mm x 16mm Hardened)	<b>B20-2000</b>	Ball Shoe, 4.939mm	<b>P20-1014</b>
Clutch Bearing (35mm x 52mm x 22mm)	<b>B20-1108</b>	Ball Shoe, 4.942mm	<b>P20-1015</b>
		Ball Shoe, 4.951mm	<b>P20-1018</b>
<b>Chemicals</b>		<b>Reeds and Valve Plates</b>	
Ultra PAG Oil 46 - 6pk, 8 oz Bottle	<b>MT3012</b>	Valve Plate	<b>H20-6010</b>
Ultra PAG Oil 46 - 6pk, Quart Bottle	<b>MT3018</b>	Reed - Discharge Valve	<b>R20-2003</b>
Ultra PAG Oil 46 - Drum (52 gal)	<b>A10-6163</b>	Reed - Suction Valve	<b>R20-1003</b>
<b>Clutch Components</b>		<b>Service Items</b>	
Clutch Coil - OD/ID: 96.6mm / 61.6mm	<b>H20-7315</b>	High Pressure Relief Valve	<b>A20-5203</b>
<b>Control Valves</b>		<b>Shaft Seals</b>	
Control Valve Filter	<b>A20-5121</b>	Lip Seal (Black Rubber Coated)	<b>HNBR S20-1007</b>
Control Valve, Early	<b>A20-5063</b>	Lip Seal Kit	<b>Green HNBR K20-3100</b>
Control Valve, Late	<b>A20-5071</b>		
<b>Fasteners</b>			
Bolt - Shipping Plate	<b>F11-2100</b>	<i>Includes: Shaft Seal Retaining Ring (1), Lip Seal (1)</i>	
Helical Insert - Rear Head / Shipping Plate (8-1.25 x 12mm)	<b>F10-6211</b>		
Retaining Ring - Clutch Pulley	<b>F25-4112</b>		
Retaining Ring - Coil	<b>F10-4130</b>		
Retaining Ring - Lip Seal	<b>F25-4111</b>		
<b>Gaskets</b>		<b>Shipping Closures</b>	
Gasket - Front Head	Fiber <b>G20-1135</b>	Shipping Pad (Discharge) (Use with C50-4101)	<b>C50-3001</b>
Gasket - Cylinder	Metal <b>G20-2136</b>	Shipping Pad (Suction) (Use with C11-4103)	<b>C11-3103</b>
Gasket - Front Head	Metal <b>G20-2135</b>	Shipping Plate (Discharge) (Use with C50-3001)	<b>C50-4101</b>
Gasket - Rear Head	Metal <b>G20-2134</b>	Shipping Plate (Suction) (Use with C11-3103)	<b>C11-4103</b>
Gasket - Discharge Housing	Green HNBR <b>G20-3116</b>	<b>Tools</b>	
Gasket Kit (Metal)	Green HNBR <b>K20-2131</b>	Helical Insert Drill for 8-1.25mm Inserts	<b>T10-6053</b>
		Helical Insert Tap 8-1.25mm	<b>T10-6254</b>
		Helical Insert Tool 8-1.25mm - Bolt Style	<b>T10-6554</b>
		Shaft Seal Protector	<b>T11-1000</b>
		Shaft Seal Protector, Adjustable	<b>T95-1227</b>
			
<i>Includes: Cylinder Gasket (1), Valve Plate Gasket (1), Front Head Gasket (1), Discharge Manifold Gasket, Pressure Relief Valve O-Ring (1).</i>			
<b>Piston Components</b>			
Ball Shoe, 4.933mm	<b>P20-1012</b>		
Ball Shoe, 4.936mm	<b>P20-1013</b>		

**DENSO**

**7SBU17C**

## DENSO

### 7SBU17C

O-Rings	R134a and R-12 Compatible	Green HNBR	Black Nitrile
Control Valve Inner Middle O-Ring		M20-2132	M20-1032
Control Valve Inner O-Ring		M96-2132	M96-1032
Control Valve Middle O-Ring		M20-2116	M20-1016
Control Valve Outer Middle O-Ring		M96-2145	
Control Valve Outer O-Ring		M20-2115	M20-1015
High Pressure Relief Valve O-Ring		M96-2118	M96-1018

#### Bearings

Clutch Bearing (35mm x 52mm x 22mm) **B20-1108**

#### Clutch Components

Clutch Coil - OD/ID: 80mm / 55mm **H20-7302**

#### Control Valves

Connector for Electronic Control Valves **E20-4010**

Control Valve (90° Terminal) **E20-7061**

Control Valve Kit **E20-2175** Electronic



Replaces:

E20-7010, E20-7011, E20-7012, E20-7013, E20-7015, E20-7017

O-Ring Kit, Control Valve (5 O-Rings) Green HNBR **K20-2165**



#### Fasteners

Bolt - Shipping Plate / Shaft **F20-2110**

Retaining Ring - Clutch Pulley **F25-4112**

Retaining Ring - Coil **F10-4130**

Retaining Ring - Lip Seal / Control Valve **F25-4111**

#### Gaskets

Gasket - Cylinder Metal **G20-2136**

Gasket - Front Head Metal **G20-2135**

Gasket - Rear Head Metal **G20-2134**

Gasket - Discharge Housing Green HNBR **G20-3116**

#### Reeds and Valve Plates

Valve Plate **H20-6010**

Reed - Discharge Valve **R20-2003**

#### Service Items

High Pressure Relief Valve **A20-5203**

#### Shaft Seals

Lip Seal (Black Rubber Coated) HNBR **S20-1007**

Lip Seal Kit Green HNBR **K20-3100**



Includes: Shaft Seal Retaining Ring (1), Lip Seal (1)

#### Tools

Shaft Seal Protector **T11-1000**

Shaft Seal Protector, Adjustable **T95-1227**

## DENSO 7SE16

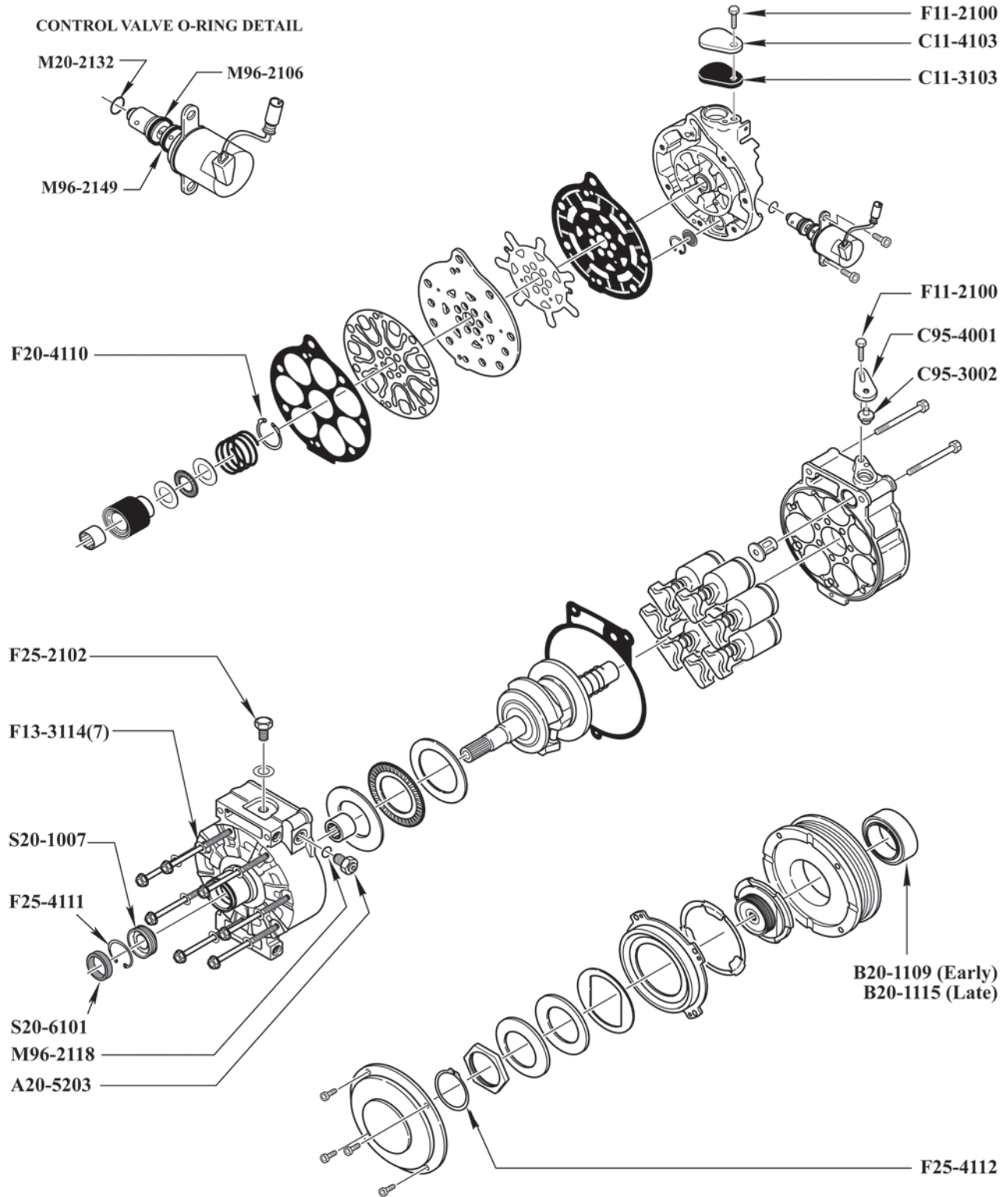

## DENSO

### 7SE16

O-Rings	R134a and R-12 Compatible	Green HNBR	Black Nitrile
Control Valve Inner O-Ring		<b>M20-2132</b>	<b>M20-1032</b>
Control Valve Middle O-Ring		<b>M65-2106</b>	<b>M65-1006</b>
Control Valve Outer O-Ring		<b>M96-2149</b>	
High Pressure Relief Valve O-Ring		<b>M96-2118</b>	<b>M96-1018</b>
Bearings		Shipping Closures	
Clutch Bearing (Early) (35mm x 52mm x 20mm)	<b>B20-1109</b>	Shipping Pad (Suction) (Use with C11-4103)	<b>C11-3103</b>
Clutch Bearing (Late) (35mm x 52mm x 12mm)	<b>B20-1115</b>	Shipping Plate (Suction) (Use with C11-3103)	<b>C11-4103</b>
Chemicals		Shipping Plate (Discharge) (Use with C95-3002)	<b>C95-4001</b>
Ultra PAG Oil 46 - 6pk, 8 oz Bottle	<b>MT3012</b>	Shipping Plug (Discharge) (Use with C95-4001)	<b>C95-3002</b>
Ultra PAG Oil 46 - 6pk, Quart Bottle	<b>MT3018</b>	Tools	
Ultra PAG Oil 46 - Drum (52 gal)	<b>A10-6163</b>	Helical Insert Drill for 8-1.25mm Inserts	<b>T10-6053</b>
Fasteners		Helical Insert Tap 8-1.25mm	<b>T10-6254</b>
Bolt - Oil Plug	<b>F25-2102</b>	Helical Insert Tool 8-1.25mm - Bolt Style	<b>T10-6554</b>
Bolt - Shipping Plate	<b>F11-2100</b>	Shaft Seal Protector, Adjustable	<b>T95-1228</b>
Helical Insert - Rear Head / Shipping Plate (8-1.25 x 12mm)	<b>F10-6211</b>	Helical Insert Repair Kit (8-1.25mm)	<b>K10-1180</b>
Retaining Ring - Lip Seal	<b>F25-4111</b>		
Retaining Ring - Pulley	<b>F25-4112</b>		
Retaining Ring - Thrust Washer Assembly	<b>F20-4110</b>		
Washer - Head Bolt	<b>F13-3114</b>		
Service Items			
High Pressure Relief Valve 3/8-24 w/Non-Captive O-Ring	<b>A10-5122</b>		
Shaft Seals			
Felt Wiper	<b>S20-6101</b>		
Lip Seal (Black Rubber Coated)	HNBR <b>S20-1007</b>		
Lip Seal Kit	Green HNBR <b>K20-3100</b>		



Includes: Helical Inserts (25), Drill (1), Tap (1), Installation Tool - Bolt Style (1)



Includes: Shaft Seal Retaining Ring (1), Lip Seal (1)

Lip Seal Kit Green HNBR **K20-3149**



Includes: Retaining Ring (1), Lip Seal (1), Felt Wiper (1)

## DENSO

### 7SEU16, 7SEU16C

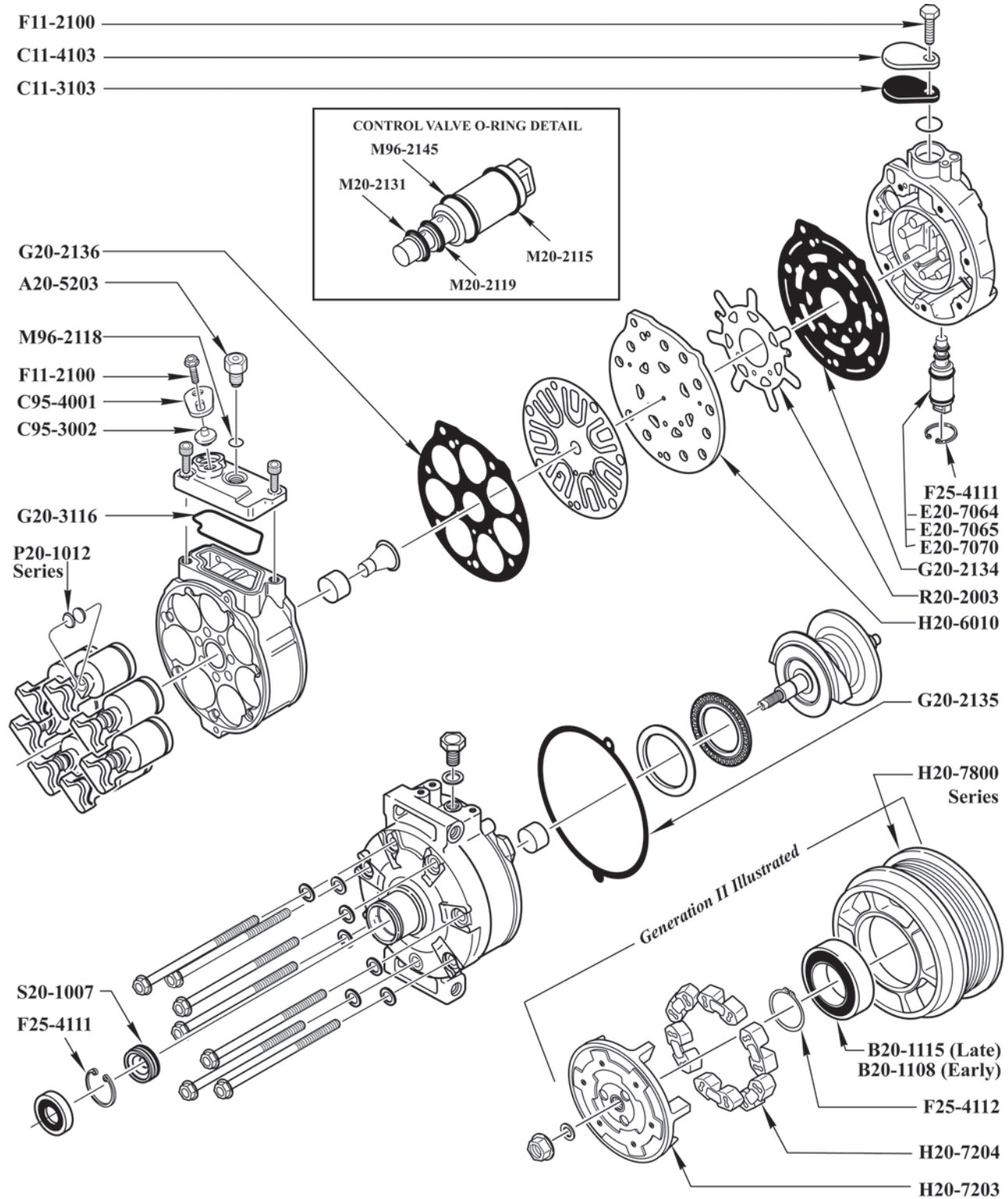

## DENSO

### 7SEU16, 7SEU16C

O-Rings	R134a and R-12 Compatible	Green HNBR	Black Nitrile
Control Valve Inner Center O-Ring		<b>M20-2119</b>	
Control Valve Inner O-Ring		<b>M20-2131</b>	
Control Valve Outer Center O-Ring		<b>M96-2145</b>	
Control Valve Outer O-Ring		<b>M20-2115</b>	<b>M20-1015</b>
High Pressure Relief Valve O-Ring		<b>M96-2118</b>	<b>M96-1018</b>

#### Bearings

Clutch Bearing (Early) (35mm x 52mm x 12mm)	<b>B20-1108</b>
Clutch Bearing (Late) (35mm x 52mm x 12mm)	<b>B20-1115</b>

#### Chemicals

Ultra PAG Oil 46 - 6pk, 8 oz Bottle	<b>MT3012</b>
Ultra PAG Oil 46 - 6pk, Quart Bottle	<b>MT3018</b>
Ultra PAG Oil 46 - Drum (52 gal)	<b>A10-6163</b>

#### Clutch Components

Generation I Metal Pulley Assembly	<b>H20-7966</b>
Generation I Direct Drive Hub	<b>H20-7205</b>
Generation I Direct Drive Hub Cover	<b>H20-7202</b>
Generation I Splined Drive Shaft	<b>H20-7950</b>
Generation II Direct Drive Hub	<b>H20-7203</b>
Generation II Direct Drive Hub Rubber Damper	<b>H20-7204</b>
Generation II Hub Metal Retaining Ring	<b>H20-7208</b>
Generation III Direct Drive Hub	<b>H20-7206</b>
Generation III Direct Drive Hub Rubber Damper	<b>H20-7207</b>
Generation I Metal Pulley - 4 Groove - Total OD: 110mm	<b>H20-7846</b>
Generation I Metal Pulley - 4 Groove - Total OD: 114mm	<b>H20-7840</b>
Generation III Metal Pulley - 4 Groove - Total OD: 100 mm	<b>H20-7871</b>
Generation III Metal Pulley - 6 Groove - Total OD: 130 mm	<b>H20-7859</b>

#### Control Valves

Connector for Electronic Control Valves	<b>E20-4010</b>
Control Valve (90° Terminal - Long Connector - No Diode)	<b>E20-7070</b>
Control Valve (90° Terminal - No Diode)	<b>E20-7064</b>
Control Valve (90° Terminal w/ Diode) (Mercedes & BMW)	<b>E20-7065</b>

#### Control Valves

Control Valve Kit (No Diode)	Electronic <b>K20-2174</b>
------------------------------	----------------------------



Replaces:

E20-7000, E20-7001, E20-7002, E20-7003, E20-7004, E20-7005, E20-7006, E20-7007, E20-7008, E20-7009, E20-7018, E20-7019

O-Ring Kit, Control Valve (4 O-Rings)	Green HNBR <b>K20-2166</b>
---------------------------------------	----------------------------



Includes: Gaskets: Control Valve O-Rings (4).

#### Fasteners

Bolt - Shipping Plate	<b>F11-2100</b>
Retaining Ring - Lip Seal / Control Valve	<b>F25-4111</b>
Retaining Ring - Pulley	<b>F25-4112</b>

#### Gaskets

Gasket - Cylinder	Metal <b>G20-2136</b>
Gasket - Front Head	Metal <b>G20-2135</b>
Gasket - Rear Head	Metal <b>G20-2134</b>
Gasket - Discharge Housing	Green HNBR <b>G20-3116</b>
Gasket Kit (Metal)	Green HNBR <b>K20-2131</b>

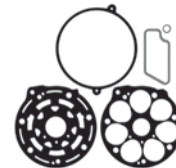

Includes: Cylinder Gasket (1), Valve Plate Gasket (1), Front Head Gasket (1), Discharge Manifold Gasket, Pressure Relief Valve O-Ring (1).

#### Piston Components

Ball Shoe, 4.933mm	<b>P20-1012</b>
--------------------	-----------------

## DENSO

7SEU16, 7SEU16C

### Piston Components

Ball Shoe, 4.936mm	<b>P20-1013</b>
Ball Shoe, 4.939mm	<b>P20-1014</b>
Ball Shoe, 4.942mm	<b>P20-1015</b>
Ball Shoe, 4.951mm	<b>P20-1018</b>

### Reeds and Valve Plates

Valve Plate	<b>H20-6010</b>
Reed - Discharge Valve	<b>R20-2003</b>

### Service Items

High Pressure Relief Valve	<b>A20-5203</b>
----------------------------	-----------------

### Shaft Seals

Felt Wiper	<b>S20-6101</b>
Lip Seal (Black Rubber Coated)	<b>HNBR S20-1007</b>
Lip Seal Kit	Green HNBR <b>K20-3100</b>



*Includes: Shaft Seal Retaining Ring (1), Lip Seal (1)*

Lip Seal Kit	Green HNBR <b>K20-3149</b>
--------------	----------------------------



*Includes: Retaining Ring (1), Lip Seal (1), Felt Wiper (1)*

### Shipping Closures

Shipping Pad (Suction) (Use with C11-4103)	<b>C11-3103</b>
Shipping Plate (Suction) (Use with C11-3103)	<b>C11-4103</b>
Shipping Plate (Discharge) (Use with C95-3002)	<b>C95-4001</b>
Shipping Plug (Discharge) (Use with C95-4001)	<b>C95-3002</b>

### Tools

Direct Drive Hub Remover	<b>T20-3004</b>
Shaft Seal Protector, Adjustable	<b>T95-1228</b>





## DENSO 7SEU17C

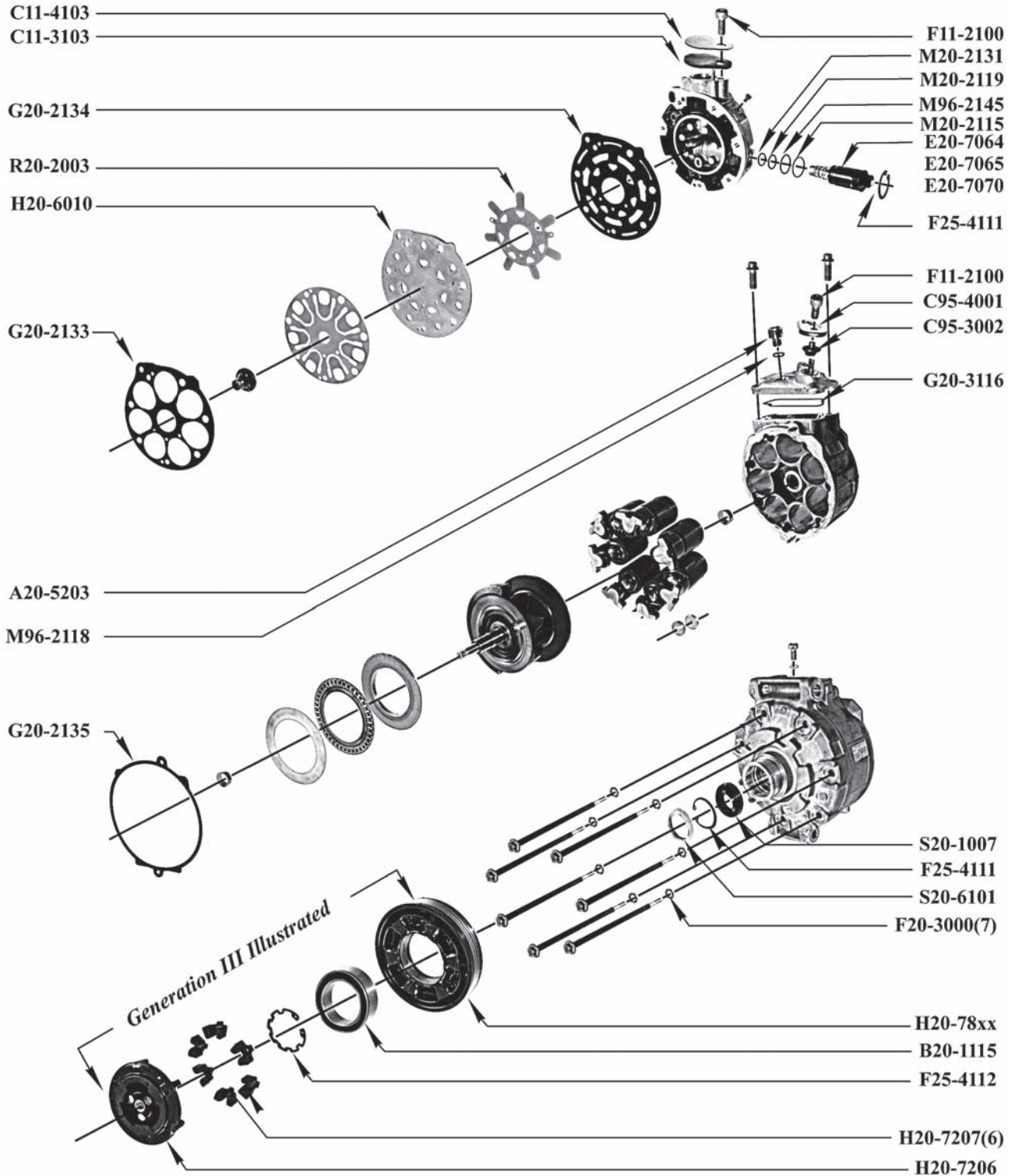

## DENSO

### 7SEU17C

O-Rings	R134a and R-12 Compatible	Green HNBR	Black Nitrile
Control Valve Inner Middle O-Ring		<b>M20-2119</b>	
Control Valve Inner O-Ring		<b>M20-2131</b>	
Control Valve Outer Middle O-Ring		<b>M96-2145</b>	
Control Valve Outer O-Ring		<b>M20-2115</b>	<b>M20-1015</b>
High Pressure Relief Valve O-Ring		<b>M96-2118</b>	<b>M96-1018</b>

Bearings	
Pulley Bearing (35mm x 52mm x 12mm)	<b>B20-1115</b>

Chemicals	
Ultra PAG Oil 46 - 6pk, 8 oz Bottle	<b>MT3012</b>
Ultra PAG Oil 46 - 6pk, Quart Bottle	<b>MT3018</b>
Ultra PAG Oil 46 - Drum (52 gal)	<b>A10-6163</b>

Clutch Components	
Breakaway Torque Drive Assembly	<b>H20-7969</b>
Generation I Metal Pulley Assembly	<b>H20-7966</b>
Generation II Composite Pulley Assembly	<b>H20-7954</b>
Generation III Direct Drive Hub	<b>H20-7206</b>
Generation III Direct Drive Hub Rubber Damper	<b>H20-7207</b>
Generation I Metal Pulley - 4 Groove - Total OD: 110mm	<b>H20-7846</b>
Generation II Composite Pulley	<b>H20-7809</b>
Generation II Composite Pulley	<b>H20-7816</b>
Generation III Metal Pulley - 6 Groove - Total OD: 105 mm	<b>H20-7866</b>
Generation III Metal Pulley - 6 Groove - Total OD: 115 mm	<b>H20-7867</b>
Generation III Metal Pulley - 6 Groove - Total OD: 130 mm	<b>H20-7859</b>

Control Valves	
Connector for Electronic Control Valves	<b>E20-4010</b>
Control Valve (90° Terminal - Long Connector)	<b>E20-7070</b>
Control Valve (90° Terminal)	<b>E20-7064</b>
Control Valve Kit	Electronic <b>K20-2174</b>



Replaces:  
E20-7000, E20-7001, E20-7002, E20-7003, E20-7004, E20-7005,  
E20-7006, E20-7007, E20-7008, E20-7009, E20-7018, E20-7019

Control Valves	
O-Ring Kit, Control Valve (4 O-Rings)	Green HNBR <b>K20-2166</b>



Includes: Gaskets: Control Valve O-Rings (4).

Fasteners	
Bolt - Shipping Plate	<b>F11-2100</b>
Retaining Ring - Clutch Pulley	<b>F25-4112</b>
Retaining Ring - Lip Seal / Control Valve	<b>F25-4111</b>
Washer - Head Bolt	<b>F20-3000</b>

Gaskets	
Gasket - Cylinder	Metal <b>G20-2136</b>
Gasket - Front Head	Metal <b>G20-2135</b>
Gasket - Rear Head	Metal <b>G20-2134</b>
Gasket - Discharge Housing	Green HNBR <b>G20-3116</b>
Gasket Kit (Metal)	Green HNBR <b>K20-2131</b>

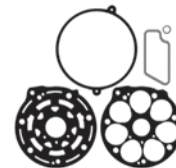

Includes: Cylinder Gasket (1), Valve Plate Gasket (1), Front Head Gasket (1), Discharge Manifold Gasket, Pressure Relief Valve O-Ring (1).

Reeds and Valve Plates	
Valve Plate	<b>H20-6010</b>
Reed - Discharge Valve	<b>R20-2003</b>

Service Items	
High Pressure Relief Valve	<b>A20-5203</b>

Shaft Seals	
Felt Wiper	<b>S20-6101</b>
Lip Seal (Black Rubber Coated)	HNBR <b>S20-1007</b>

## DENSO 7SEU17C

### Shaft Seals

Lip Seal Kit

Green HNBR **K20-3100**



*Includes: Shaft Seal Retaining Ring (1), Lip Seal (1)*

### Shipping Closures

Shipping Pad (Suction) (Use with C11-4103) **C11-3103**

Shipping Plate (Suction) (Use with C11-3103) **C11-4103**

Shipping Plate (Discharge) (Use with C95-3002) **C95-4001**

Shipping Plug (Discharge) (Use with C95-4001) **C95-3002**

### Tools

Shaft Seal Protector, Adjustable **T95-1227**



## DENSO

### 10P08E

Note: Early models of the Nippondenso 10P08E use Carbon Seals.  
The Lip Seal does not retrofit for Carbon Seal units.

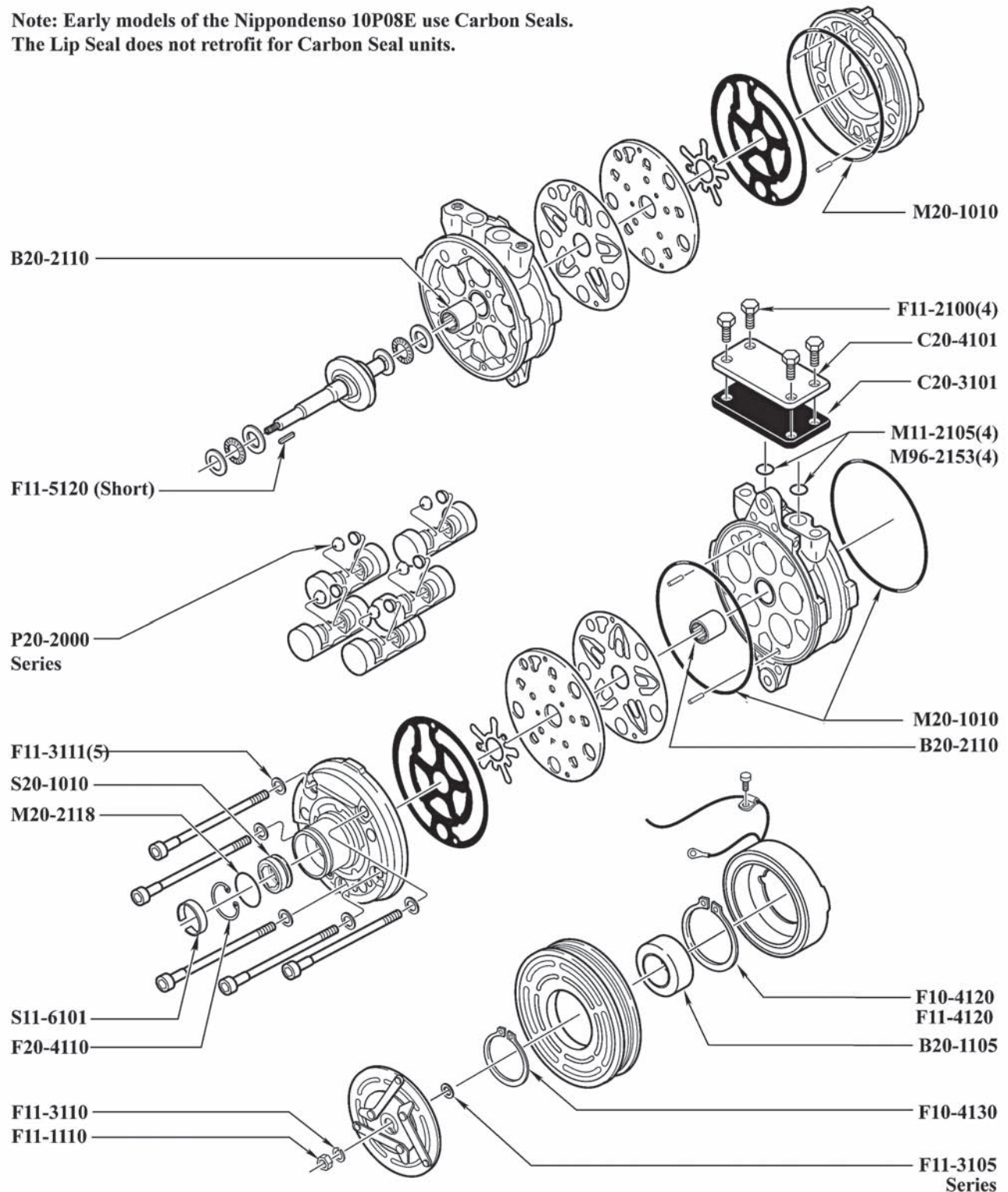

## DENSO

### 10P08E

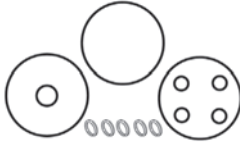
O-Rings	R134a and R-12 Compatible	Green HNBR	Black Nitrile
Carbon Shaft Seal O-Ring		<b>M96-2134</b>	<b>M96-1034</b>
Case O-Ring			<b>M20-1010</b>
Shaft Seal Seat (Pre 1992) /Lip Seal O-Ring		<b>M20-2118</b>	<b>M20-1018</b>
Suction / Discharge Port O-Ring (Aftermarket Hose Assembly)		<b>M11-2105</b>	<b>M11-1005</b>
Suction / Discharge Port O-Ring (Factory Hose Assembly)		<b>M96-2153</b>	<b>M96-1053</b>
Bearings		Fasteners	
Case Bearing (16mm x 23mm x 16mm)	<b>B20-2110</b>	Clutch Installation Kit	<b>K20-5110</b>
Clutch Bearing (38mm x 54mm x 17mm)	<b>B20-1105</b>	 <p><i>Includes: Coil Retaining Ring (0.078" - 1.198 mm Thick) (1), Coil Retaining Ring - (0.062 - 1.57 mm Thick) (1), Pulley Retaining Ring (1), Shaft Locknut (1), Shaft Lockwasher (1), Hub Shim - .020" Thick (5), Shaft Key (Long) (1), Shaft Key (Short) (1)</i></p>	
Chemicals			
Ultra PAG Oil 46 - 6pk, 8 oz Bottle	<b>MT3012</b>	Gaskets	
Ultra PAG Oil 46 - 6pk, Quart Bottle	<b>MT3018</b>	Gasket - Manifold / Diffuser	Green HNBR <b>G20-3107</b> (Geo/Suzuki)
Ultra PAG Oil 46 - Drum (52 gal)	<b>A10-6163</b>	O-Ring Kit	Black Nitrile <b>K20-2025</b>
Clutch Components		 <p><i>Includes: Head Bolt Washer (5), Case O-Ring (3), Metal Shaft Seal Seat O-Ring (Pre 1992)/Lip Seal O-Ring (1), Suction / Discharge Port O-Ring (4)</i></p>	
Fasteners			
Bolt - Shipping Plate	<b>F11-2100</b>	Piston Components	
Helical Insert - Rear Head / Shipping Plate (8-1.25 x 12mm)	<b>F10-6211</b>	Ball Shoe No.10	<b>P20-2009</b>
Nut - Shaft	<b>F11-1110</b>	Ball Shoe No.8	<b>P20-2007</b>
Shaft Key (Short - 11.9mm x 4.0mm)	<b>F11-5120</b>	Ball Shoe No.9	<b>P20-2008</b>
Retaining Ring - Coil (1.57mm)	<b>F11-4120</b>	Service Items	
Retaining Ring - Coil (1.98mm)	<b>F10-4120</b>	Fitting (Refrigerant) - 1/8" NPT Brass Port w/ Valve	<b>A10-1024</b>
Retaining Ring - Lip Seal/Metal Shaft Seal Seat	<b>F20-4110</b>	Valve Core - Standard Pressure	<b>A10-1120</b>
Retaining Ring - Pulley	<b>F10-4130</b>	Shaft Seals	
Lockwasher - Shaft	<b>F11-3110</b>	Carbon Shaft Seal (Pre 1992)	HNBR <b>S11-2101</b>
Shim - Clutch (0.20mm)	<b>F11-3105</b>	Felt Wiper	<b>S11-6101</b>
Shim - Clutch (0.51mm)	<b>F11-3115</b>	Lip Seal (Triple)	Nitrile <b>S20-1010</b>
Washer - Head Bolt	<b>F11-3111</b>	Metal Shaft Seal Seat	<b>S11-3101</b>
Clutch Installation Kit	<b>K20-5010</b>		



*Includes: Coil Retaining Ring (0.078" - 1.198 mm Thick) (1), Coil Retaining Ring - (0.062 - 1.57 mm Thick) (1), Pulley Retaining Ring (1), Shaft Locknut (1), Shaft Lockwasher (1), Hub Shim - .020" Thick (5)*

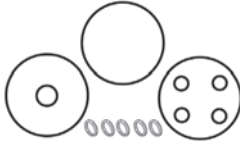

*Includes: Head Bolt Washer (5), Case O-Ring (3), Metal Shaft Seal Seat O-Ring (Pre 1992)/Lip Seal O-Ring (1), Suction / Discharge Port O-Ring (4)*

## DENSO 10P08E

### Shaft Seals

Carbon Shaft Seal Kit (Pre 1992) Green HNBR **K20-3115**



*Includes: Head Bolt Washer (6), Lip Seal/Metal Shaft Seal Retaining Ring (1), Lip Seal/Metal Shaft Seal Seat O-Ring (Pre-92) (1), Carbon Shaft Seal (Pre-92) (1), Metal Shaft Seal Seat (1)*

Lip Seal Kit Green HNBR **K20-3130**



*Includes: Lip Seal Retaining Ring (1), Lip Seal (1), Lip Seal O-Ring (1).*

### Shipping Closures

Cap - 1/4" Low Side **C10-1000**  
Shipping Pad (Use with C20-4101) **C20-3101**  
Shipping Plate (Use with C20-3101) **C20-4101**

### Tools

Helical Insert Drill for 8-1.25mm Inserts **T10-6053**  
Helical Insert Tap 8-1.25mm **T10-6254**  
Helical Insert Tool 8-1.25mm - Bolt Style **T10-6554**  
Shaft Seal Installer / Remover (Aftermarket) **T20-3002**  
Shaft Seal Protector, Adjustable **T95-1228**  
Shaft Seal Seat Installer / Remover (O.E.) **T60-3001**  
Helical Insert Repair Kit (8-1.25mm) **K10-1180**



*Includes: Helical Inserts (25), Drill (1), Tap (1), Installation Tool - Bolt Style (1)*





## DENSO

10P13A, 10P13B, 10P13C, 10P13E, 10P13F, 10P15C, 10P15E, 10P15F

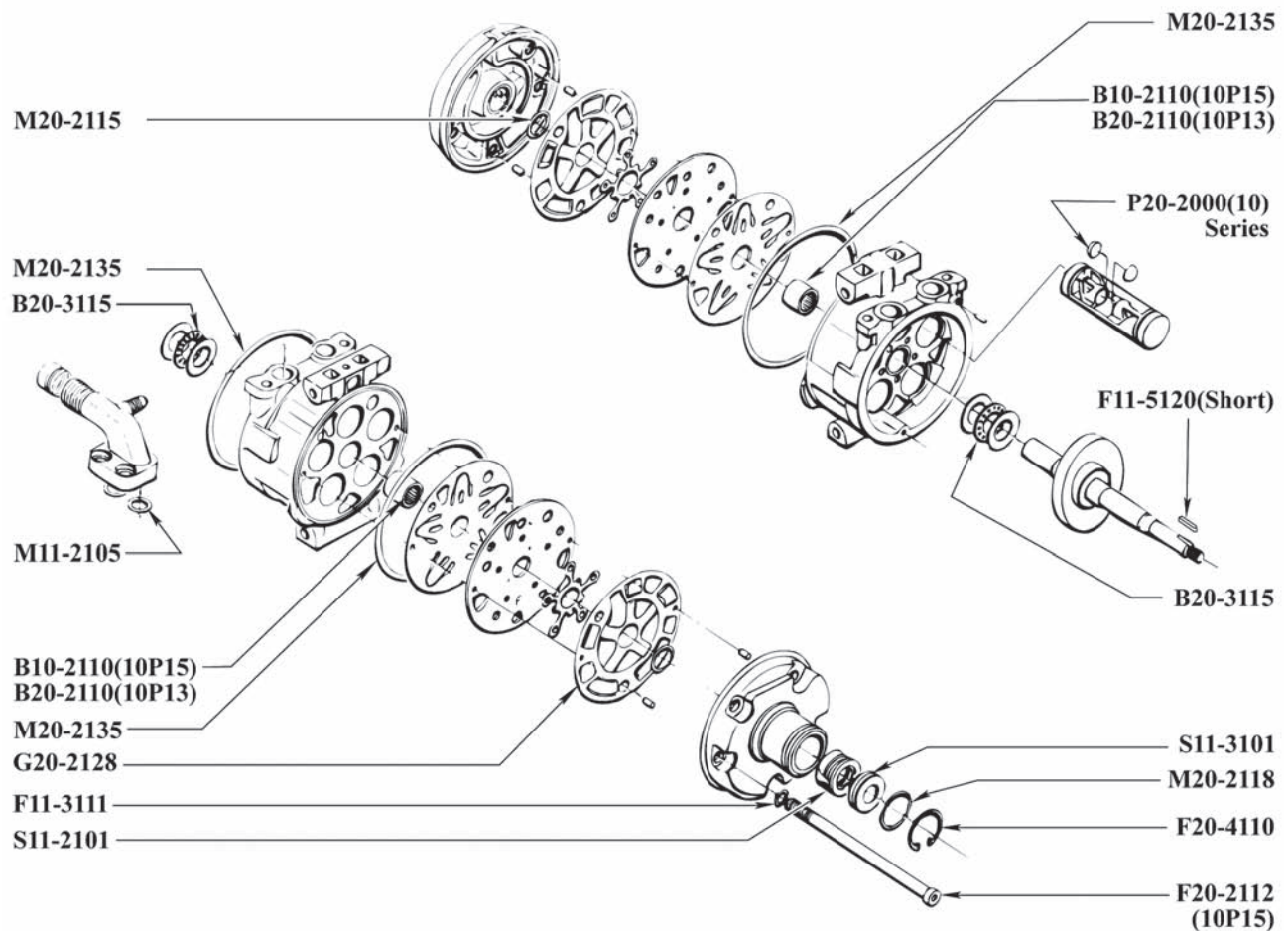

## DENSO

10P13A, 10P13B, 10P13C, 10P13E, 10P13F, 10P15C, 10P15E, 10P15F

O-Rings	R134a and R-12 Compatible	Green HNBR	Black Nitrile
Body Sensor Port O-Ring		M20-2116	M20-1016
Carbon Shaft Seal O-Ring		M96-2134	M96-1034
Carbon Shaft Seal O-Ring (for O.E. Seal)		M96-2133	M96-1033
Case O-Ring		M20-2135	M20-1035
Fitting (Refrigerant) - 1/8" NPT Brass Port w/ Valve O-Ring		M20-2160	
Rear Head Sensor Port O-Ring (For C20-2001-Toyota/Mercedes)		M20-2171	M20-1071
Shaft Seal Seat/Lip Seal O-Ring		M20-2118	M20-1018
Suc/Disch Port (All) / Rear Sensor Port (10P15C) O-Ring		M96-2153	M96-1053
Suction / Discharge Port O-Ring (Aftermarket Hose Assembly)		M11-2105	M11-1005
Suction Port O-Ring (use with G11-2165) (Jeep Only)		M20-2160	
Valve Plate O-Ring		M20-2115	M20-1015
Bearings		Fasteners	
Case Bearing (16mm x 23mm x 16mm) (10P13)	B20-2110	Clutch Installation Kit	K20-5010
Case Bearing (16mm x 23mm x 21.9mm) (10P15)	B10-2110		
Clutch Bearing (40mm x 62mm x 24mm)	B25-1100	<p><i>Includes: Coil Retaining Ring (0.078" - 1.198 mm Thick) (1), Coil Retaining Ring - (0.062 - 1.57 mm Thick) (1), Pully Retaining Ring (1), Shaft Locknut (1), Shaft Lockwasher (1), Hub Shim - .020" Thick (5)</i></p>	
Thrust Bearing (17.3mm x 34mm x 3mm)	B20-3115	Clutch Installation Kit	K20-5110
Chemicals			
Ultra PAG Oil 46 - 6pk, 8 oz Bottle	MT3012	<p><i>Includes: Coil Retaining Ring (0.078" - 1.198 mm Thick) (1), Coil Retaining Ring - (0.062 - 1.57 mm Thick) (1), Pully Retaining Ring (1), Shaft Locknut (1), Shaft Lockwasher (1), Hub Shim - .020" Thick (5), Shaft Key (Long) (1), Shaft Key (Short) (1)</i></p>	
Ultra PAG Oil 46 - 6pk, Quart Bottle	MT3018		
Ultra PAG Oil 46 - Drum (52 gal)	A10-6163		
Clutch Components			
Clutch Coil - OD/ID: 107mm / 71mm	H20-7325		
Electrical			
Clutch Coil Pigtail	E12-4000		
Fasteners			
Bolt - Head (10P15)	F20-2112		
Bolt - Shipping Plate	F11-2100		
Helical Insert - Rear Head / Shipping Plate (8-1.25 x 12mm)	F10-6211		
Nut - Shaft	F11-1110		
Shaft Key (Short - 11.9mm x 4.0mm)	F11-5120		
Retaining Ring - Coil (1.57mm)	F11-4120		
Retaining Ring - Coil (1.98mm)	F10-4120		
Retaining Ring - Pulley	F10-4130		
Retaining Ring - Rear Head Sensor Port	F20-4000		
Retaining Ring - Shaft Seal Seat	F20-4110		
Lockwasher - Shaft	F11-3110		
Shim - Clutch (0.20mm)	F11-3105		
Shim - Clutch (0.51mm)	F11-3115		
Washer - Head Bolt	F11-3111		
Gaskets			
Gasket - Front Housing	Metal G20-2128		
Gasket - Manifold / Diffuser	Green HNBR G20-3107		
Gasket - Manifold / Diffuser (10P15)	Black HNBR G20-3114		
Gasket - Manifold / Diffuser (10P15)	Black HNBR G20-3115		

## DENSO

10P13A, 10P13B, 10P13C, 10P13E, 10P13F, 10P15C, 10P15E, 10P15F

### Gaskets

O-Ring Kit

Green HNBR **K20-2130**

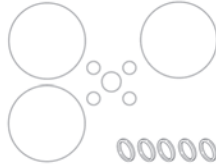

Includes: Head Bolt Washer (5), Case O-Ring (3), Metal Shaft Seal Seat O-Ring (Pre 1992)/Lip Seal O-Ring (1), Suction / Discharge Port O-Ring (4)

O-Ring Kit

Black Nitrile **K20-2030**

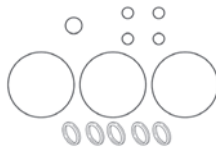

Includes: Head Bolt Washer (5), Case O-Ring (3), Metal Shaft Seal Seat (1), Suction/Discharge Port O-Ring (4).

### Shaft Seals

Carbon Shaft Seal Kit

Green HNBR **K20-3135**

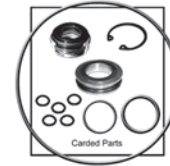

Includes: Head Bolt Washer (5), Metal Shaft Seal Seat Retaining Ring (1), Metal Shaft Seal Seat O-Ring (1), Carbon Shaft Seal (1), Metal Shaft Seal Seat (1), Case O-Ring (1), Valve Plate O-Ring (1)

Lip Seal Kit

Green HNBR **K20-3130**



Includes: Lip Seal Retaining Ring (1), Lip Seal (1), Lip Seal O-Ring (1).

### Piston Components

Ball Shoe No.10	<b>P20-2009</b>
Ball Shoe No.8	<b>P20-2007</b>
Ball Shoe No.9	<b>P20-2008</b>

### Service Items

Fitting (Refrigerant) - 1/8" NPT Brass Port w/ Valve	<b>A10-1024</b>
--	-----------------

### Shaft Seals

Carbon Shaft Seal	HNBR <b>S11-2101</b>
Felt Wiper	<b>S20-6101</b>
Lip Seal (Triple)	Nitrile <b>S20-1010</b>
Metal Shaft Seal Seat	<b>S11-3101</b>
Carbon Shaft Seal Kit	Green HNBR <b>K20-3115</b>



Includes: Head Bolt Washer (6), Lip Seal/Metal Shaft Seal Retaining Ring (1), Lip Seal/Metal Shaft Seal Seat O-Ring (Pre-92) (1), Carbon Shaft Seal (Pre-92) (1), Metal Shaft Seal Seat (1)

### Shipping Closures

Cap - 1/4" Low Side	<b>C10-1000</b>
Discharge Cap w/ O-Ring - 4/5" (.800") Height	<b>C25-1112</b>
Discharge Cap w/ O-Ring - 5/8" (.625") Height	<b>C25-1110</b>
Plug - Rear Head Sensor Port (Mercedes) (use M96-2153)	<b>C20-2000</b>
Plug - Rear Head Sensor Port (Toyota/Mercedes)(use M20-2171)	<b>C20-2001</b>
Suction Cap w/ Disc - 1" Height	<b>C25-1113</b>
Suction Cap w/ Disc - 7/9" (.701") Height	<b>C25-1111</b>
Shipping Pad (Use with C20-4100)	<b>C12-3100</b>
Shipping Plate (Use with 2 C12-3100) (Covers all 4 ports)	<b>C20-4100</b>
Shipping Plate (Use with C95-3003 & C95-3004)	<b>C95-4001</b>
Shipping Plug (Discharge) (Use with C95-4001)	<b>C95-3004</b>
Shipping Plug (Suction) (Use with C95-4001)	<b>C95-3003</b>

### Tools

Clutch Puller	<b>T65-1000</b>
Helical Insert Drill for 8-1.25mm Inserts	<b>T10-6053</b>
Helical Insert Tap 8-1.25mm	<b>T10-6254</b>
Helical Insert Tool 8-1.25mm - Bolt Style	<b>T10-6554</b>
Shaft Seal Installer / Remover (Aftermarket)	<b>T20-3002</b>
Shaft Seal Protector, Adjustable	<b>T95-1228</b>
Shaft Seal Seat Installer / Remover (O.E.)	<b>T60-3001</b>

## DENSO

10P13A, 10P13B, 10P13C, 10P13E, 10P13F, 10P15C, 10P15E, 10P15F

### Tools

Helical Insert Repair Kit (8-1.25mm)

**K10-1180**



*Includes: Helical Inserts (25), Drill (1), Tap (1), Installation Tool - Bolt Style (1)*

## DENSO

### 10P17, 10P17C, 10P17VC

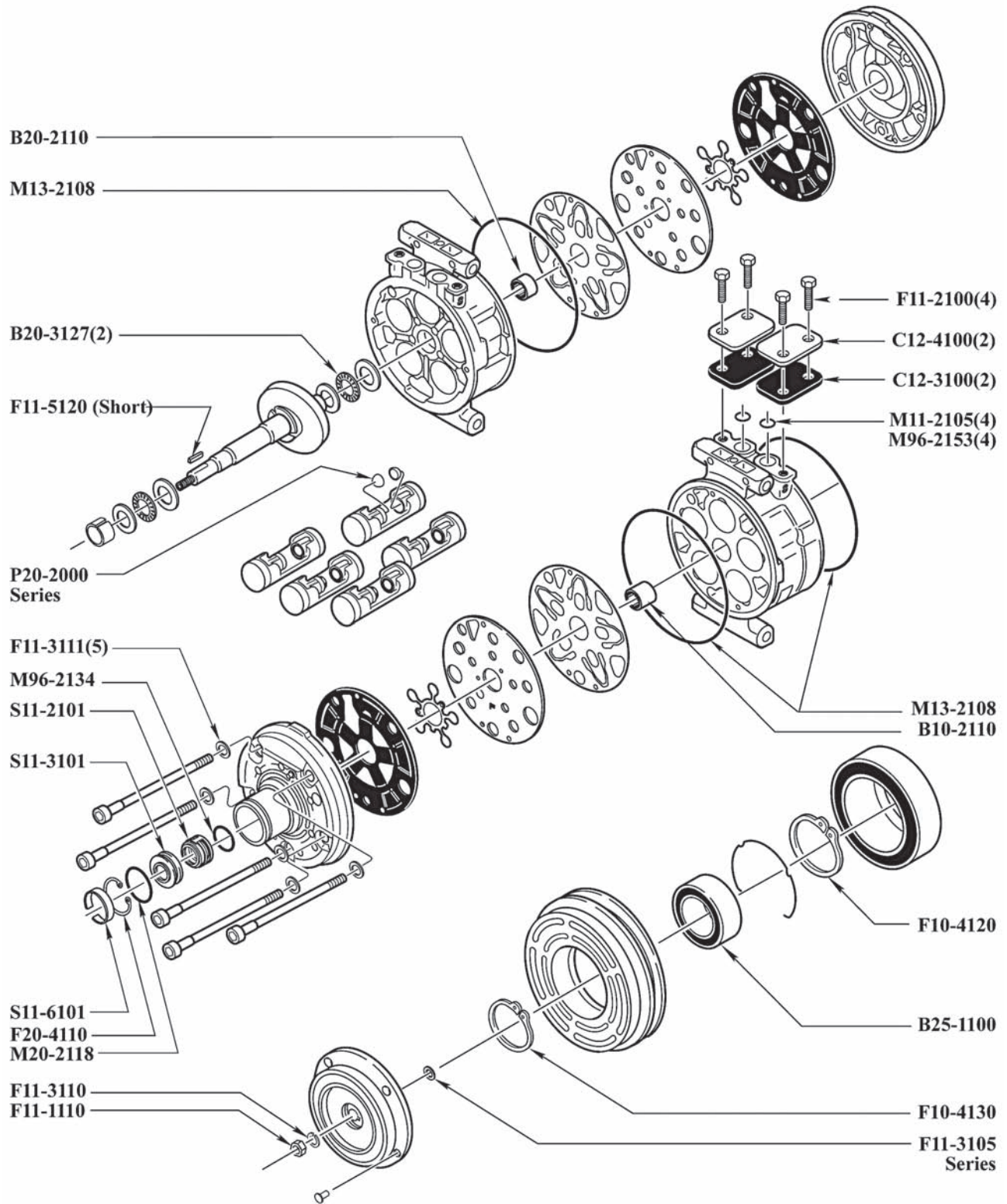

## DENSO

### 10P17, 10P17C, 10P17VC

O-Rings	R134a and R-12 Compatible	Green HNBR	Black Nitrile
Body Sensor Port O-Ring		<b>M20-2116</b>	<b>M20-1016</b>
Carbon Shaft Seal O-Ring		<b>M96-2134</b>	<b>M96-1034</b>
Case O-Ring		<b>M13-2108</b>	<b>M13-1008</b>
Fitting (Refrigerant) - 1/8" NPT Brass Port w/ Valve O-Ring		<b>M20-2160</b>	
Shaft Seal Seat O-Ring		<b>M20-2118</b>	<b>M20-1018</b>
Suction / Discharge Port O-Ring (Aftermarket Hose Assembly)		<b>M11-2105</b>	<b>M11-1005</b>
Suction / Discharge Port O-Ring (Factory Hose Assembly)		<b>M96-2153</b>	<b>M96-1053</b>

#### Bearings

Case Bearing (Front) (16mm x 23mm x 21.9mm)	<b>B10-2110</b>
Case Bearing (Rear) (16mm x 23mm x 16mm)	<b>B20-2110</b>
Clutch Bearing (40mm x 57mm x 20mm-24mm) (Audi & Mercedes)	<b>B20-1107</b>
Clutch Bearing (40mm x 62mm x 24mm)	<b>B25-1100</b>
Thrust Bearing (17mm x 34mm x 2.4mm)	<b>B20-3127</b>

#### Chemicals

Ultra PAG Oil 46 - 6pk, 8 oz Bottle	<b>MT3012</b>
Ultra PAG Oil 46 - 6pk, Quart Bottle	<b>MT3018</b>
Ultra PAG Oil 46 - Drum (52 gal)	<b>A10-6163</b>

#### Fasteners

Bolt - Shipping Plate	<b>F11-2100</b>
Helical Insert - Rear Head / Shipping Plate (8-1.25 x 12mm)	<b>F10-6211</b>
Nut - Shaft	<b>F11-1110</b>
Shaft Key (Short - 11.9mm x 4.0mm)	<b>F11-5120</b>
Retaining Ring - Coil (1.57mm)	<b>F11-4120</b>
Retaining Ring - Coil (1.98mm)	<b>F10-4120</b>
Retaining Ring - Pulley	<b>F10-4130</b>
Retaining Ring - Shaft Seal Seat	<b>F20-4110</b>
Lockwasher - Shaft	<b>F11-3110</b>
Shim - Clutch (0.20mm)	<b>F11-3105</b>
Shim - Clutch (0.51mm)	<b>F11-3115</b>
Washer - Head Bolt	<b>F11-3111</b>
Clutch Installation Kit	<b>K20-5010</b>



Includes: Coil Retaining Ring (0.078" - 1.198 mm Thick) (1), Coil Retaining Ring - (0.062 - 1.57 mm Thick) (1), Pulley Retaining Ring (1), Shaft Locknut (1), Shaft Lockwasher (1), Hub Shim - .020" Thick (5)

#### Fasteners

Clutch Installation Kit	<b>K20-5110</b>
-------------------------	-----------------



Includes: Coil Retaining Ring (0.078" - 1.198 mm Thick) (1), Coil Retaining Ring - (0.062 - 1.57 mm Thick) (1), Pulley Retaining Ring (1), Shaft Locknut (1), Shaft Lockwasher (1), Hub Shim - .020" Thick (5), Shaft Key (Long) (1), Shaft Key (Short) (1)

#### Gaskets

Gasket - Manifold (Audi)	Black HNBR <b>G20-3117</b>
Gasket - Manifold / Diffuser	Green HNBR <b>G20-3107</b>
O-Ring Kit	Green HNBR <b>K20-2102</b>

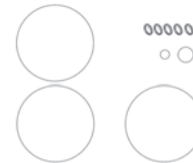

Includes: Head Bolt Washer (5), Metal Shaft Seal Seat O-Ring (1), Carbon Shaft Seal O-Ring (1), Case O-Ring (3)

#### O-Ring Kit

Black Nitrile **K20-2002**

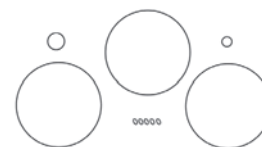

Includes: Head Bolt Washer (5), Metal Shaft Seal Seat O-Ring (1), Carbon Shaft Seal O-Ring (1), Case O-Ring (3)

#### Piston Components

Ball Shoe No.10	<b>P20-2009</b>
Ball Shoe No.8	<b>P20-2007</b>
Ball Shoe No.9	<b>P20-2008</b>

## DENSO

10P17, 10P17C, 10P17VC

### Service Items

Fitting (Refrigerant) - 1/8" NPT Brass Port w/ Valve **A10-1024**

### Shaft Seals

Carbon Shaft Seal **HNBR S11-2101**

Felt Wiper **S11-6101**

Metal Shaft Seal Seat **S11-3101**

Carbon Shaft Seal Kit **Green HNBR K20-3115**



*Includes: Head Bolt Washer (6), Lip Seal/Metal Shaft Seal Retaining Ring (1), Lip Seal/Metal Shaft Seal Seat O-Ring (Pre-92) (1), Carbon Shaft Seal (Pre-92) (1), Metal Shaft Seal Seat (1)*

### Shipping Closures

Shipping Pad (Use with C12-4100 or C12-4101) **C12-3100**

Shipping Plate (Use with 2 C12-3100) (Covers all 4 ports) **C12-4101**

Shipping Plate (Use with C12-3100) **C12-4100**

Shipping Plate (Use with C95-3002 & C95-3004) **C95-4001**

Shipping Plug (Discharge) (Use with C95-4001) **C95-3002**

Shipping Plug (Suction) (Use with C95-4001) **C95-3004**

### Tools

Clutch Puller **T65-1000**

Helical Insert Drill for 8-1.25mm Inserts **T10-6053**

Helical Insert Tap 8-1.25mm **T10-6254**

Helical Insert Tool 8-1.25mm - Bolt Style **T10-6554**

Shaft Seal Installer / Remover (Aftermarket) **T20-3002**

Shaft Seal Protector, Adjustable **T95-1228**

Shaft Seal Seat Installer / Remover (O.E.) **T60-3001**

Helical Insert Repair Kit (8-1.25mm) **K10-1180**



*Includes: Helical Inserts (25), Drill (1), Tap (1), Installation Tool - Bolt Style (1)*





## DENSO

10PA15A, 10PA15C, 10PA15E, 10PA15L, 10PA15LC, 10PA15SC, 10PA17A, 10PA17C, 10PA17E,  
10PA17H, 10PA17J, 10PA17K

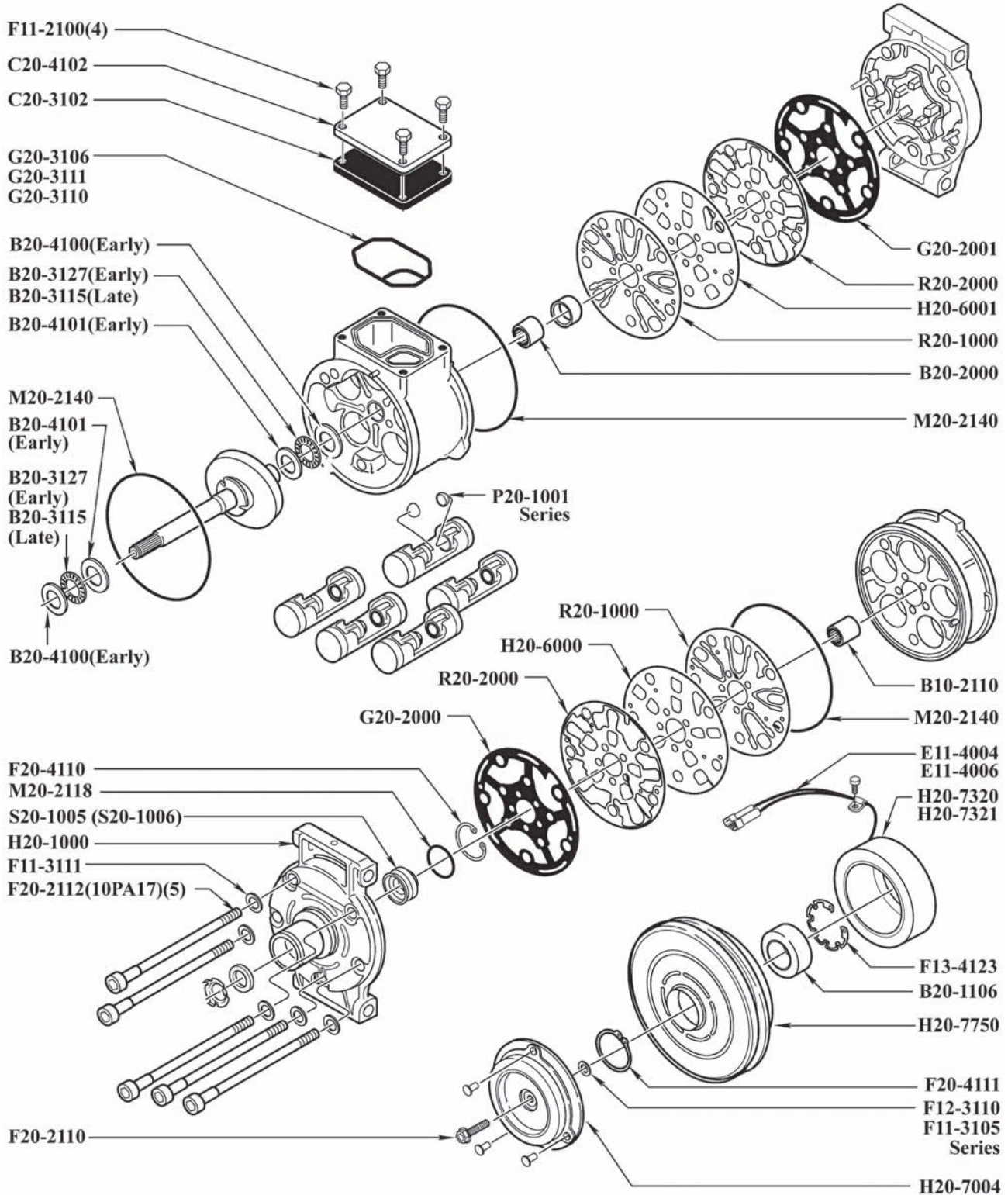

## DENSO

10PA15A, 10PA15C, 10PA15E, 10PA15L, 10PA15LC, 10PA15SC, 10PA17A, 10PA17C, 10PA17E, 10PA17H, 10PA17J, 10PA17K

O-Rings	R134a and R-12 Compatible	Green HNBR	Black Nitrile
Body Sensor Port O-Ring		M20-2116	M20-1016
Carbon Shaft Seal O-Ring		M96-2134	M96-1034
Case O-Ring		M20-2140	M20-1040
Rear Head Sensor Port O-Ring		M20-2171	M20-1071
Rear Head Sensor Port O-Ring		M96-2144	M96-1044
Rear Head Sensor Port O-Ring (for C20-2000) (Mercedes)		M96-2153	M96-1053
Shaft Seal Seat / Lip Seal O-Ring		M20-2118	M20-1018
Suction/Discharge O-Ring w/ Tabs (Mercedes)		G20-3112	
Bearings		Fasteners	
Case Bearing (Front) (16mm x 23mm x 21.9mm)	B10-2110	Helical Insert - Rear Head / Shipping Plate (8-1.25 x 12mm)	F10-6211
Case Bearing (Rear) (15mm x 23mm x 16mm Hardened)	B20-2000	Retaining Ring - Clutch Coil	F13-4123
Clutch Bearing (30mm x 52mm x 22mm)	B20-1106	Retaining Ring - Lip Seal	F20-4110
Clutch Bearing (30mm x 52mm x 22mm) O.E.	B20-1906	Retaining Ring - Pulley	F12-4110
Clutch Bearing (35mm x 52mm x 22mm) (Mercedes)	B20-1108	Retaining Ring - Pulley	F20-4111
Thrust Bearing (Early) (17mm x 34mm x 2.4mm)	B20-3127	Retaining Ring - Pulley (Mercedes)	F25-4112
Thrust Bearing (Late) (17.3mm x 34mm x 3mm)	B20-3115	Retaining Ring - Rear Head Sensor Port	F20-4000
Thrust Race (Early) (Cylinder Side) (17mm x 34mm x 2.24mm)	B20-4100	Shim - Clutch (0.20mm)	F11-3105
Thrust Race (Early) (Swash Plate Side) (17mm x 37mm x 2.24mm)	B20-4101	Shim - Clutch (0.38mm)	F12-3110
		Shim - Clutch (0.51mm)	F11-3115
Chemicals		Washer - Head Bolt	F11-3111
Ultra PAG Oil 46 - 6pk, 8 oz Bottle	MT3012	Clutch Installation Kit	K20-5107
Ultra PAG Oil 46 - 6pk, Quart Bottle	MT3018		
Ultra PAG Oil 46 - Drum (52 gal)	A10-6163		
Clutch Components			
Clutch Coil - 12 Volt	H20-7320		
Clutch Coil - 24 Volt	H20-7321		
Clutch Hub - OD: 102mm	H20-7004		
Clutch Pulley - 1 Groove w/Bearing (123.8mm)	H20-7750		
Clutch Pulley - 6 Groove w/ Bearing (135mm)	H20-7722		
Electrical			
Clutch Coil Connector - 3 Pin (BMW 10PA17C)	E20-4000		
Clutch Coil Pigtail - 1-Pin	E11-4006		
Clutch Coil Pigtail - 2-Pin	E11-4004		
Fasteners			
Bolt - Head (10PA17)	F20-2112		
Bolt - Shaft	F20-2110		
Bolt - Shipping Plate	F11-2100		
		Gaskets	
		Gasket - Front Head	Metal G20-2000
		Gasket - Rear Head	Metal G20-2001
		Gasket - Suction / Discharge Port	Green HNBR G20-3106
		Gasket - Suction / Discharge Port (10PA15C Mercedes)	Green HNBR G20-3111
		Gasket - Suction / Discharge Port (10PA17C BMW)	Green HNBR G20-3110



Includes: Coil Retaining Ring (1), Pulley Retaining Ring (1), Shaft Bolt (1), Shim (0.20mm) (1), Shim (0.38mm) (1), Shim (0.51mm) (1).

## DENSO

10PA15A, 10PA15C, 10PA15E, 10PA15L, 10PA15LC, 10PA15SC, 10PA17A, 10PA17C, 10PA17E, 10PA17H, 10PA17J, 10PA17K

### Gaskets

Gasket Kit

Metal **K20-2048**



Includes: Front Head Metal Gasket (1), Rear Head Metal Gasket (1).

Gasket Kit

Green HNBR **K20-2146**

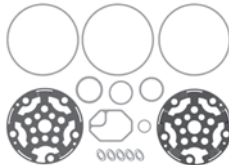

Includes: Head Gaskets (2), Head Bolt Washer (5), Suction / Discharge Port Gasket - HNBR (1), Bottom/Side Switch O-Ring (1), Metal Shaft Seal Seat O-Ring (1), Case O-Ring (3), Lip Seal O-Ring (1), Switch Port O-Ring (1)

Gasket Kit (BMW Only)

Green HNBR **K20-2159**

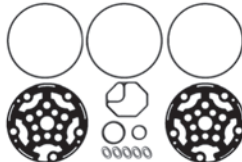

Includes: Front Head Gasket (1), Rear Head Gasket (1), Suction/Discharge Port Gasket (1), Head Bolt Washer (5), Case O-Ring (3), Lip Seal O-Ring (1), Body Sensor O-Ring (1).

Gasket Kit (Mercedes)

Green HNBR **K20-2158**

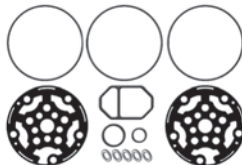

Includes: Front Head Gasket (1), Rear Head Gasket (1), Suction/Discharge Port Gasket (1), Head Bolt Washer (5), Case O-Ring (3), Lip Seal O-Ring (1), Body Sensor O-Ring (1).

### Gaskets

10PA15/10PA17 O-ring Kit -  
Nitrile W/O gaskets

Black Nitrile **K20-2045**

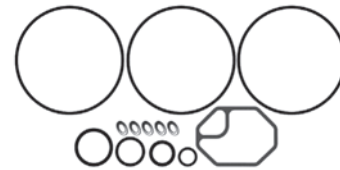

Includes: Head Bolt Washer (5), Suction / Discharge Port Gasket - HNBR (1), Bottom/Side Switch O-Ring (1), Metal Shaft Seal Seat O-Ring (1), Case O-Ring (3), Lip Seal O-Ring (1), Switch Port O-Ring (1)

Gasket Kit

Black Nitrile **K20-2046**

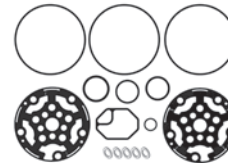

Includes: Head Gaskets (2), Head Bolt Washer (5), Suction / Discharge Port Gasket - HNBR (1), Bottom/Side Switch O-Ring (1), Metal Shaft Seal Seat O-Ring (1), Case O-Ring (3), Lip Seal O-Ring (1), Switch Port O-Ring (1)

### Hard Components

Housing (Head) - Front **H20-1000**

Housing (Head) - Front **H20-1000**

(10PA15C/17C/17E/17K)

### Piston Components

Ball Shoe 7.890 - 7.895mm **P20-1001**

Ball Shoe 7.895 - 7.900mm **P20-1002**

Ball Shoe 7.900 - 7.905mm **P20-1003**

Ball Shoe 7.905 - 7.910mm **P20-1004**

Ball Shoe 7.910 - 7.915mm **P20-1005**

Ball Shoe 7.915 - 7.920mm **P20-1006**

Ball Shoe 7.920 - 7.925mm **P20-1007**

Ball Shoe 7.925 - 7.930mm **P20-1008**

Ball Shoe 7.930 - 7.935mm **P20-1009**

Ball Shoe 7.935 - 7.940mm **P20-1010**

### Reeds and Valve Plates

Valve Plate (Front) **H20-6000**

Valve Plate (Rear) **H20-6001**

Reed - Discharge Valve **R20-2000**

Reed - Suction Valve **R20-1000**

### Service Items

High Pressure Relief Valve **A20-5203**

Fitting (Refrigerant) - 1/8" NPT Brass Port w/ Valve **A10-1024**

## DENSO

**10PA15A, 10PA15C, 10PA15E, 10PA15L, 10PA15LC, 10PA15SC, 10PA17A, 10PA17C, 10PA17E, 10PA17H, 10PA17J, 10PA17K**

### Shaft Seals

Carbon Shaft Seal (Early)	HNBR <b>S11-2101</b>
Lip Seal (Black Rubber Coated)	HNBR <b>S20-1006</b>
Lip Seal (Metal Can)	Nitrile <b>S20-1005</b>
Metal Shaft Seal Seat (Early)	<b>S11-3101</b>
Carbon Shaft Seal Kit	Green HNBR <b>K20-3115</b>



*Includes: Head Bolt Washer (6), Lip Seal/Metal Shaft Seal Retaining Ring (1), Lip Seal/Metal Shaft Seal Seat O-Ring (Pre-92) (1), Carbon Shaft Seal (Pre-92) (1), Metal Shaft Seal Seat (1)*

Lip Seal Kit Black Nitrile **K20-3045**



*Includes: Shaft Seal Retaining Ring (1), Lip Seal (1), Head Bolt Washers (5), Case O-Ring (1)*

Lip Seal Kit Green HNBR **K20-3145**



*Includes: Head Bolt Washer (5), Metal Shaft Seal Seat Retaining Ring (1), Lip Seal (1), Case O-Ring (1)*

Lip Seal Kit (Black Rubber Coated) Green HNBR **K20-3146**



*Includes: Lip Seal (1), Lip Seal Retaining Ring (1)*

### Shaft Seals

Lip Seal Kit (Can Type) Green HNBR **K20-3147**



*Includes: Lip Seal (1), Lip Seal Retaining Ring (1)*

### Shipping Closures

Plug - Rear Head Sensor Port (Mercedes) (use M96-2153)	<b>C20-2000</b>
Shipping Cap - Nose Protector	<b>C20-1000</b>
Shipping Pad (Use with C20-4102)	<b>C20-3102</b>
Shipping Pad (Use with C25-4105) (Mercedes)	<b>C13-3000</b>
Shipping Plate (Use with 2 C13-3000) (Mercedes)	<b>C25-4105</b>
Shipping Plate (Use with C20-3102)	<b>C20-4102</b>

### Tools

Helical Insert Drill for 8-1.25mm Inserts	<b>T10-6053</b>
Helical Insert Tap 8-1.25mm	<b>T10-6254</b>
Helical Insert Tool 8-1.25mm - Bolt Style	<b>T10-6554</b>
Shaft Seal Installer / Remover (Aftermarket)	<b>T20-3002</b>
Shaft Seal Protector, Adjustable	<b>T95-1227</b>
Shaft Seal Seat Installer / Remover (O.E.)	<b>T60-3001</b>
Helical Insert Repair Kit (8-1.25mm)	<b>K10-1180</b>



*Includes: Helical Inserts (25), Drill (1), Tap (1), Installation Tool - Bolt Style (1)*

## DENSO

### 10PA15VC, 10PA17VC, 10PA17VSC

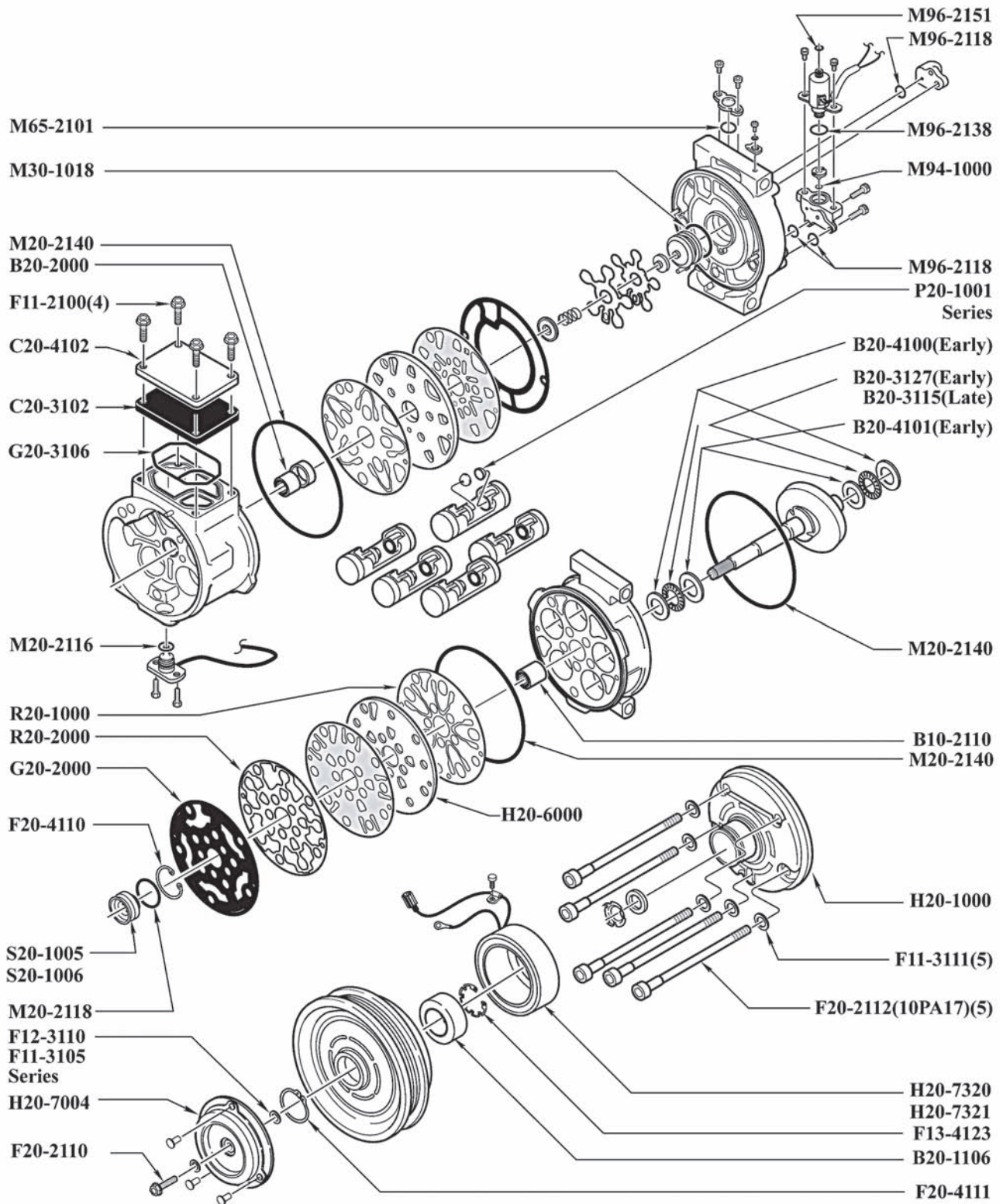

## DENSO

### 10PA15VC, 10PA17VC, 10PA17VSC

O-Rings	R134a and R-12 Compatible	Green HNBR	Black Nitrile
Body Sensor Port O-Ring		M20-2116	M20-1016
Case O-Ring		M20-2140	M20-1040
Control Valve Mount / High PSI Relief Valve O-Ring		M96-2118	M96-1018
Control Valve Plunger O-Ring (Bottom)			M94-1000
Control Valve Plunger O-Ring (Center)		M96-2138	M96-1038
Control Valve Plunger O-Ring (Top)		M96-2151	M96-1051
Rear Head Plate O-Ring		M65-2101	
Rear Plunger O-Ring			M30-1018
Shaft Seal Seat / Lip Seal O-Ring		M20-2118	M20-1018

Bearings	
Case Bearing (Front) (16mm x 23mm x 21.9mm)	B10-2110
Case Bearing (Rear) (15mm x 23mm x 16mm Hardened)	B20-2000
Clutch Bearing (30mm x 52mm x 22mm)	B20-1106
Thrust Bearing (Early) (17mm x 34mm x 2.4mm)	B20-3127
Thrust Bearing (Late) (17.3mm x 34mm x 3mm)	B20-3115
Thrust Race (Early) (Cylinder Side) (17mm x 34mm x 2.24mm)	B20-4100
Thrust Race (Early) (Swash Plate Side) (17mm x 37mm x 2.24mm)	B20-4101

Chemicals	
Ultra PAG Oil 46 - 6pk, 8 oz Bottle	MT3012
Ultra PAG Oil 46 - 6pk, Quart Bottle	MT3018
Ultra PAG Oil 46 - Drum (52 gal)	A10-6163

Clutch Components	
Clutch Coil - 12 Volt	H20-7320
Clutch Coil - 24 Volt	H20-7321
Clutch Hub - OD: 102mm	H20-7004

Control Valves	
Control Valve / Switch O-Ring Kit	Black Nitrile K20-2047



Includes: Bottom/Side Switch O-Ring (1), Control Valve Mount/PRV O-Ring (3), Control Valve Plunger O-Ring (Small) (1), Control Valve Plunger O-Ring (Large) (1), Control Valve Plunger Top O-Ring (1), Rear Plunger O-Ring (1).

Electrical	
Clutch Coil Pigtail	E11-4000
Fasteners	
Bolt - Head	F20-2112
Bolt - Head (10PA17)	F20-2112
Bolt - Shaft	F20-2110
Bolt - Shipping Plate	F11-2100
Helical Insert - Rear Head / Shipping Plate (8-1.25 x 12mm)	F10-6211
Retaining Ring - Clutch Coil	F13-4123
Retaining Ring - Lip Seal	F20-4110
Retaining Ring - Pulley	F12-4110
Retaining Ring - Pulley	F20-4111
Shim - Clutch (0.20mm)	F11-3105
Shim - Clutch (0.38mm)	F12-3110
Shim - Clutch (0.51mm)	F11-3115
Washer - Head Bolt	F11-3111
Clutch Installation Kit	K20-5107



Includes: Coil Retaining Ring (1), Pulley Retaining Ring (1), Shaft Bolt (1), Shim (0.20mm) (1), Shim (0.38mm) (1), Shim (0.51mm) (1).

Gaskets	
Gasket - Front Head	Metal G20-2000
Gasket - Suction / Discharge Port	Green HNBR G20-3106
Hard Components	
Housing (Head) - Front	H20-1000
Piston Components	
Ball Shoe 7.890 - 7.895mm	P20-1001
Ball Shoe 7.895 - 7.900mm	P20-1002

## DENSO

### 10PA15VC, 10PA17VC, 10PA17VSC

#### Piston Components

Ball Shoe 7.900 - 7.905mm	<b>P20-1003</b>
Ball Shoe 7.905 - 7.910mm	<b>P20-1004</b>
Ball Shoe 7.910 - 7.915mm	<b>P20-1005</b>
Ball Shoe 7.915 - 7.920mm	<b>P20-1006</b>
Ball Shoe 7.920 - 7.925mm	<b>P20-1007</b>
Ball Shoe 7.925 - 7.930mm	<b>P20-1008</b>
Ball Shoe 7.930 - 7.935mm	<b>P20-1009</b>
Ball Shoe 7.935 - 7.940mm	<b>P20-1010</b>

#### Reeds and Valve Plates

Valve Plate (Front)	<b>H20-6000</b>
Reed - Discharge Valve	<b>R20-2000</b>
Reed - Discharge Valve (Front)	<b>R20-2000</b>
Reed - Suction Valve	<b>R20-1000</b>
Reed - Suction Valve (Front)	<b>R20-1000</b>

#### Service Items

High Pressure Relief Valve	<b>A20-5203</b>
Fitting (Refrigerant) - 1/8" NPT Brass Port w/ Valve	<b>A10-1024</b>

#### Shaft Seals

Lip Seal (Black Rubber Coated)	HNBR <b>S20-1006</b>
Lip Seal (Metal Can)	Nitrile <b>S20-1005</b>
Lip Seal Kit (Black Rubber Coated)	Green HNBR <b>K20-3146</b>



Includes: Lip Seal (1), Lip Seal Retaining Ring (1).

Lip Seal Kit (Can Type)	Green HNBR <b>K20-3147</b>
-------------------------	----------------------------



Includes: Lip Seal (1), Lip Seal Retaining Ring (1).

#### Shipping Closures

Shipping Cap - Nose Protector	<b>C20-1000</b>
Shipping Pad (Use with C20-4102)	<b>C20-3102</b>
Shipping Plate (Use with C20-3102)	<b>C20-4102</b>

#### Tools

Shaft Seal Installer / Remover (Aftermarket)	<b>T20-3002</b>
Shaft Seal Protector, Adjustable	<b>T95-1227</b>
Shaft Seal Seat Installer / Remover (O.E.)	<b>T60-3001</b>
Helical Insert Repair Kit (8-1.25mm)	<b>K10-1180</b>



Includes: Helical Inserts (25), Drill (1), Tap (1), Installation Tool - Bolt Style (1)





## DENSO

### 10PA15VL, 10PA17VL

O-Rings	R134a and R-12 Compatible	Green HNBR	Black Nitrile
Bottom/Side Switch O-Ring		<b>M20-2116</b>	<b>M20-1016</b>
Case O-Ring		<b>M20-2140</b>	<b>M20-1040</b>
Control Valve Mount / High PSI Relief Valve O-Ring		<b>M96-2118</b>	<b>M96-1018</b>
Control Valve Plunger O-Ring (Bottom)			<b>M94-1000</b>
Control Valve Plunger O-Ring (Center)		<b>M96-2138</b>	<b>M96-1038</b>
Control Valve Plunger O-Ring (Top)		<b>M96-2151</b>	<b>M96-1051</b>
Rear Plunger O-Ring			<b>M30-1018</b>
Shaft Seal Seat / Lip Seal O-Ring		<b>M20-2118</b>	<b>M20-1018</b>

Bearings	
Case Bearing (Front) (16mm x 23mm x 21.9mm)	<b>B10-2110</b>
Case Bearing (Rear) (15mm x 23mm x 16mm Hardened)	<b>B20-2000</b>
Clutch Bearing (30mm x 52mm x 22mm)	<b>B20-1106</b>
Thrust Bearing (Early) (17mm x 34mm x 2.4mm)	<b>B20-3127</b>
Thrust Bearing (Late) (17.3mm x 34mm x 3mm)	<b>B20-3115</b>
Thrust Race (Early) (Cylinder Side) (17mm x 34mm x 2.24mm)	<b>B20-4100</b>
Thrust Race (Early) (Swash Plate Side) (17mm x 37mm x 2.24mm)	<b>B20-4101</b>

Chemicals	
Ultra PAG Oil 46 - 6pk, 8 oz Bottle	<b>MT3012</b>
Ultra PAG Oil 46 - 6pk, Quart Bottle	<b>MT3018</b>
Ultra PAG Oil 46 - Drum (52 gal)	<b>A10-6163</b>

Clutch Components	
Clutch Coil - 12 Volt	<b>H20-7320</b>
Clutch Coil - 24 Volt	<b>H20-7321</b>
Clutch Hub - OD: 102mm	<b>H20-7004</b>

Control Valves	
Control Valve / Switch O-Ring Kit	Black Nitrile <b>K20-2047</b>



Includes: Bottom/Side Switch O-Ring (1), Control Valve Mount/PRV O-Ring (3), Control Valve Plunger O-Ring (Small) (1), Control Valve Plunger O-Ring (Large) (1), Control Valve Plunger Top O-Ring (1), Rear Plunger O-Ring (1).

Fasteners	
Bolt - Shaft	<b>F20-2110</b>

Fasteners	
Retaining Ring - Clutch Coil	<b>F13-4123</b>
Retaining Ring - Pulley	<b>F12-4110</b>
Retaining Ring - Pulley	<b>F20-4111</b>
Shim - Clutch (0.20mm)	<b>F11-3105</b>
Shim - Clutch (0.38mm)	<b>F12-3110</b>
Shim - Clutch (0.51mm)	<b>F11-3115</b>
Washer - Head Bolt	<b>F11-3111</b>
Clutch Installation Kit	<b>K20-5107</b>



Includes: Coil Retaining Ring (1), Pulley Retaining Ring (1), Shaft Bolt (1), Shim (0.20mm) (1), Shim (0.38mm) (1), Shim (0.51mm) (1).

Gaskets	
Gasket - Front Head	Metal <b>G20-2000</b>
Gasket - Rear Head	Metal <b>G20-2001</b>
Gasket - Suction / Discharge Port	Green HNBR <b>G20-3106</b>

Piston Components	
Ball Shoe 7.890 - 7.895mm	<b>P20-1001</b>
Ball Shoe 7.895 - 7.900mm	<b>P20-1002</b>
Ball Shoe 7.900 - 7.905mm	<b>P20-1003</b>
Ball Shoe 7.905 - 7.910mm	<b>P20-1004</b>
Ball Shoe 7.910 - 7.915mm	<b>P20-1005</b>
Ball Shoe 7.915 - 7.920mm	<b>P20-1006</b>
Ball Shoe 7.920 - 7.925mm	<b>P20-1007</b>
Ball Shoe 7.925 - 7.930mm	<b>P20-1008</b>
Ball Shoe 7.930 - 7.935mm	<b>P20-1009</b>
Ball Shoe 7.935 - 7.940mm	<b>P20-1010</b>

Reeds and Valve Plates	
Valve Plate (Front)	<b>H20-6000</b>
Valve Plate (Rear)	<b>H20-6001</b>

## DENSO

### 10PA15VL, 10PA17VL

#### Reeds and Valve Plates

Reed - Discharge Valve **R20-2000**

Reed - Suction Valve **R20-1000**

#### Service Items

Fitting (Refrigerant) - 1/8" NPT Brass Port w/  
Valve **A10-1024**

#### Shaft Seals

Lip Seal (Black Rubber  
Coated) HNBR **S20-1006**

Lip Seal (Metal Can) Nitrile **S20-1005**

#### Shipping Closures

Shipping Cap - Nose Protector **C20-1000**



Shipping Pad (Use with C20-4102) **C20-3102**

Shipping Plate (Use with C20-3102) **C20-4102**

#### Tools

Shaft Seal Protector, Adjustable **T95-1227**

## DENSO 10PA17SC

O-Rings	R134a and R-12 Compatible	Green HNBR	Black Nitrile
Body Sensor Port O-Ring		<b>M20-2116</b>	<b>M20-1016</b>
Carbon Shaft Seal O-Ring		<b>M96-2134</b>	<b>M96-1034</b>
Case O-Ring		<b>M20-2140</b>	<b>M20-1040</b>
Shaft Seal Seat / Lip Seal O-Ring		<b>M20-2118</b>	<b>M20-1018</b>
Bearings		Fasteners	
Case Bearing (Front) (16mm x 23mm x 21.9mm)	<b>B10-2110</b>	Clutch Installation Kit	<b>K20-5107</b>
Case Bearing (Rear) (15mm x 23mm x 16mm Hardened)	<b>B20-2000</b>		
Clutch Bearing (30mm x 52mm x 22mm)	<b>B20-1106</b>		
Thrust Bearing (Early) (17mm x 34mm x 2.4mm)	<b>B20-3127</b>	<p><i>Includes: Coil Retaining Ring (1), Pulley Retaining Ring (1), Shaft Bolt (1), Shim (0.20mm) (1), Shim (0.38mm) (1), Shim (0.51mm) (1).</i></p>	
Thrust Bearing (Late) (17.3mm x 34mm x 3mm)	<b>B20-3115</b>	Gaskets	
Thrust Race (Early) (Cylinder Side) (17mm x 34mm x 2.24mm)	<b>B20-4100</b>	Gasket - Front Head	Metal <b>G20-2000</b>
Thrust Race (Early) (Swash Plate Side) (17mm x 37mm x 2.24mm)	<b>B20-4101</b>	Gasket - Rear Head	Metal <b>G20-2001</b>
Chemicals		Gasket - Suction / Discharge Port	Green HNBR <b>G20-3106</b>
Ultra PAG Oil 46 - 6pk, 8 oz Bottle	<b>MT3012</b>	Gasket Kit	Metal <b>K20-2048</b>
Ultra PAG Oil 46 - 6pk, Quart Bottle	<b>MT3018</b>		
Ultra PAG Oil 46 - Drum (52 gal)	<b>A10-6163</b>		
Clutch Components		<p><i>Includes: Front Head Metal Gasket (1), Rear Head Metal Gasket (1).</i></p>	
Clutch Coil - 12 Volt	<b>H20-7320</b>	Piston Components	
Clutch Coil - 24 Volt	<b>H20-7321</b>	Ball Shoe 7.890 - 7.895mm	<b>P20-1001</b>
Clutch Hub - OD: 102mm	<b>H20-7004</b>	Ball Shoe 7.895 - 7.900mm	<b>P20-1002</b>
Electrical		Ball Shoe 7.900 - 7.905mm	<b>P20-1003</b>
Clutch Coil Pigtail - 1-Pin	<b>E11-4006</b>	Ball Shoe 7.905 - 7.910mm	<b>P20-1004</b>
Clutch Coil Pigtail - 2-Pin	<b>E11-4004</b>	Ball Shoe 7.910 - 7.915mm	<b>P20-1005</b>
Fasteners		Ball Shoe 7.915 - 7.920mm	<b>P20-1006</b>
Bolt - Head	<b>F20-2112</b>	Ball Shoe 7.920 - 7.925mm	<b>P20-1007</b>
Bolt - Shaft	<b>F20-2110</b>	Ball Shoe 7.925 - 7.930mm	<b>P20-1008</b>
Bolt - Shipping Plate	<b>F11-2100</b>	Ball Shoe 7.930 - 7.935mm	<b>P20-1009</b>
Helical Insert - Rear Head / Shipping Plate (8-1.25 x 12mm)	<b>F10-6211</b>	Ball Shoe 7.935 - 7.940mm	<b>P20-1010</b>
Retaining Ring - Clutch Coil	<b>F13-4123</b>	Reeds and Valve Plates	
Retaining Ring - Lip Seal	<b>F20-4110</b>	Reed - Discharge Valve	<b>R20-2000</b>
Retaining Ring - Pulley	<b>F12-4110</b>	Reed - Suction Valve	<b>R20-1000</b>
Retaining Ring - Pulley	<b>F20-4111</b>	Service Items	
Shim - Clutch (0.20mm)	<b>F11-3105</b>	Fitting (Refrigerant) - 1/8" NPT Brass Port w/ Valve	<b>A10-1024</b>
Shim - Clutch (0.38mm)	<b>F12-3110</b>		
Shim - Clutch (0.51mm)	<b>F11-3115</b>		
Washer - Head Bolt	<b>F11-3111</b>		

## DENSO 10PA17SC

### Shaft Seals

Carbon Shaft Seal (Early)	HNBR <b>S11-2101</b>
Lip Seal (Black Rubber Coated)	HNBR <b>S20-1006</b>
Lip Seal (Metal Can)	Nitrile <b>S20-1005</b>
Metal Shaft Seal Seat (Early)	<b>S11-3101</b>
Carbon Shaft Seal Kit	Green HNBR <b>K20-3115</b>



*Includes: Head Bolt Washer (6), Lip Seal/Metal Shaft Seal Retaining Ring (1), Lip Seal/Metal Shaft Seal Seat O-Ring (Pre-92) (1), Carbon Shaft Seal (Pre-92) (1), Metal Shaft Seal Seat (1)*

Lip Seal Kit (Black Rubber Coated)	Green HNBR <b>K20-3146</b>
------------------------------------	----------------------------



*Includes: Lip Seal (1), Lip Seal Retaining Ring (1).*

Lip Seal Kit (Can Type)	Green HNBR <b>K20-3147</b>
-------------------------	----------------------------



*Includes: Lip Seal (1), Lip Seal Retaining Ring (1).*

### Shipping Closures

Shipping Cap - Nose Protector	<b>C20-1000</b>
Shipping Pad (Use with C20-4102)	<b>C20-3102</b>
Shipping Plate (Use with C20-3102)	<b>C20-4102</b>

### Tools

Shaft Seal Installer / Remover (Aftermarket)	<b>T20-3002</b>
Shaft Seal Seat Installer / Remover (O.E.)	<b>T60-3001</b>

### Tools

Helical Insert Repair Kit (8-1.25mm)	<b>K10-1180</b>
--------------------------------------	-----------------



*Includes: Helical Inserts (25), Drill (1), Tap (1), Installation Tool - Bolt Style (1)*

## DENSO

### 10PA17SH

O-Rings	R134a and R-12 Compatible	Green HNBR	Black Nitrile
Body Sensor Port O-Ring		<b>M20-2116</b>	<b>M20-1016</b>
Carbon Shaft Seal O-Ring		<b>M96-2134</b>	<b>M96-1034</b>
Case O-Ring		<b>M20-2140</b>	<b>M20-1040</b>
Shaft Seal Seat / Lip Seal O-Ring		<b>M20-2118</b>	<b>M20-1018</b>
Bearings			
Case Bearing (Front) (16mm x 23mm x 21.9mm)	<b>B10-2110</b>		
Case Bearing (Rear) (15mm x 23mm x 16mm Hardened)	<b>B20-2000</b>		
Clutch Bearing (30mm x 52mm x 22mm)	<b>B20-1106</b>		
Thrust Bearing (Early) (17mm x 34mm x 2.4mm)	<b>B20-3127</b>		
Thrust Bearing (Late) (17.3mm x 34mm x 3mm)	<b>B20-3115</b>		
Thrust Race (Early) (Cylinder Side) (17mm x 34mm x 2.24mm)	<b>B20-4100</b>		
Thrust Race (Early) (Swash Plate Side) (17mm x 37mm x 2.24mm)	<b>B20-4101</b>		
Chemicals			
Ultra PAG Oil 46 - 6pk, 8 oz Bottle	<b>MT3012</b>		
Ultra PAG Oil 46 - 6pk, Quart Bottle	<b>MT3018</b>		
Ultra PAG Oil 46 - Drum (52 gal)	<b>A10-6163</b>		
Clutch Components			
Clutch Coil - 12 Volt	<b>H20-7320</b>		
Clutch Coil - 24 Volt	<b>H20-7321</b>		
Clutch Hub - OD: 102mm	<b>H20-7004</b>		
Electrical			
Clutch Coil Pigtail - 1-Pin	<b>E11-4006</b>		
Clutch Coil Pigtail - 2-Pin	<b>E11-4004</b>		
Fasteners			
Bolt - Head	<b>F20-2112</b>		
Bolt - Shaft	<b>F20-2110</b>		
Bolt - Shipping Plate	<b>F11-2100</b>		
Helical Insert - Rear Head / Shipping Plate (8-1.25 x 12mm)	<b>F10-6211</b>		
Retaining Ring - Clutch Coil	<b>F13-4123</b>		
Retaining Ring - Lip Seal	<b>F20-4110</b>		
Retaining Ring - Pulley	<b>F12-4110</b>		
Retaining Ring - Pulley	<b>F20-4111</b>		
Shim - Clutch (0.20mm)	<b>F11-3105</b>		
Shim - Clutch (0.38mm)	<b>F12-3110</b>		
Shim - Clutch (0.51mm)	<b>F11-3115</b>		
Washer - Head Bolt	<b>F11-3111</b>		

#### Fasteners

Clutch Installation Kit

**K20-5107**



Includes: Coil Retaining Ring (1), Pulley Retaining Ring (1), Shaft Bolt (1), Shim (0.20mm) (1), Shim (0.38mm) (1), Shim (0.51mm) (1).

#### Gaskets

Gasket - Front Head

Metal **G20-2000**

Gasket - Rear Head

Metal **G20-2001**

Gasket - Suction / Discharge Port

Green HNBR **G20-3106**

Gasket Kit

Metal **K20-2048**

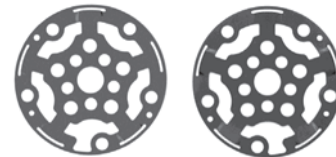

Includes: Front Head Metal Gasket (1), Rear Head Metal Gasket (1).

Gasket Kit

Green HNBR **K20-2146**

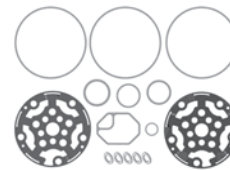

Includes: Head Gaskets (2), Head Bolt Washer (5), Suction / Discharge Port Gasket - HNBR (1), Bottom/Side Switch O-Ring (1), Metal Shaft Seal Seat O-Ring (1), Case O-Ring (3), Lip Seal O-Ring (1), Switch Port O-Ring (1)

## DENSO

### 10PA17SH

#### Gaskets

Gasket Kit

Black Nitrile **K20-2046**

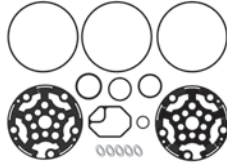

Includes: Head asks (2), Head Bolt Washer (5), Suction / Discharge Port Gasket - HNBR (1), Bottom/Side Switch O-Ring (1), Metal Shaft Seal Seat O-Ring (1), Case O-Ring (3), Lip Seal O-Ring (1), Switch Port O-Ring (1)

#### Piston Components

Ball Shoe 7.890 - 7.895mm	<b>P20-1001</b>
Ball Shoe 7.895 - 7.900mm	<b>P20-1002</b>
Ball Shoe 7.900 - 7.905mm	<b>P20-1003</b>
Ball Shoe 7.905 - 7.910mm	<b>P20-1004</b>
Ball Shoe 7.910 - 7.915mm	<b>P20-1005</b>
Ball Shoe 7.915 - 7.920mm	<b>P20-1006</b>
Ball Shoe 7.920 - 7.925mm	<b>P20-1007</b>
Ball Shoe 7.925 - 7.930mm	<b>P20-1008</b>
Ball Shoe 7.930 - 7.935mm	<b>P20-1009</b>
Ball Shoe 7.935 - 7.940mm	<b>P20-1010</b>

#### Reeds and Valve Plates

Reed - Discharge Valve	<b>R20-2000</b>
Reed - Suction Valve	<b>R20-1000</b>

#### Service Items

Fitting (Refrigerant) - 1/8" NPT Brass Port w/ Valve	<b>A10-1024</b>
--	-----------------

#### Shaft Seals

Carbon Shaft Seal (Early)	HNBR <b>S11-2101</b>
Lip Seal (Black Rubber Coated)	HNBR <b>S20-1006</b>
Lip Seal (Metal Can)	Nitrile <b>S20-1005</b>
Metal Shaft Seal Seat (Early)	<b>S11-3101</b>
Carbon Shaft Seal Kit	Green HNBR <b>K20-3115</b>



Includes: Head Bolt Washer (6), Lip Seal/Metal Shaft Seal Retaining Ring (1), Lip Seal/Metal Shaft Seal Seat O-Ring (Pre-92) (1), Carbon Shaft Seal (Pre-92) (1), Metal Shaft Seal Seat (1)

#### Shaft Seals

Lip Seal Kit (Black Rubber Coated)

Green HNBR **K20-3146**



Includes: Lip Seal (1), Lip Seal Retaining Ring (1).

Lip Seal Kit (Can Type)

Green HNBR **K20-3147**



Includes: Lip Seal (1), Lip Seal Retaining Ring (1).

#### Shipping Closures

Shipping Cap - Nose Protector	<b>C20-1000</b>
Shipping Pad (Use with C20-4102)	<b>C20-3102</b>
Shipping Plate (Use with C20-3102)	<b>C20-4102</b>

#### Tools

Shaft Seal Installer / Remover (Aftermarket)	<b>T20-3002</b>
Shaft Seal Seat Installer / Remover (O.E.)	<b>T60-3001</b>
Helical Insert Repair Kit (8-1.25mm)	<b>K10-1180</b>



Includes: Helical Inserts (25), Drill (1), Tap (1), Installation Tool - Bolt Style (1)

## DENSO

### 10PA20, 10PA20C, 10PA20H, 10PA20J

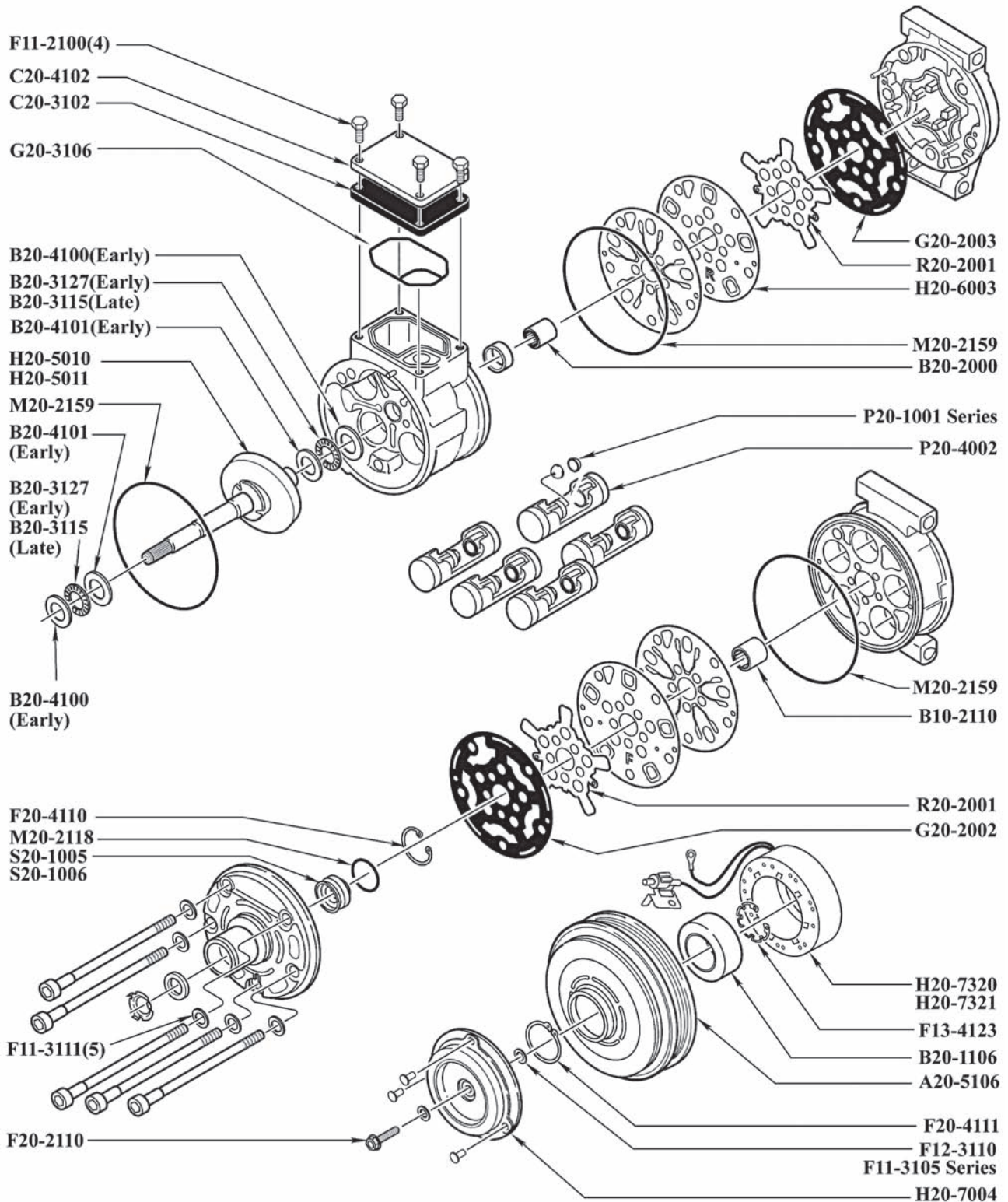



## DENSO

10PA20, 10PA20C, 10PA20H, 10PA20J

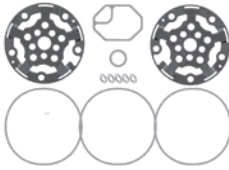
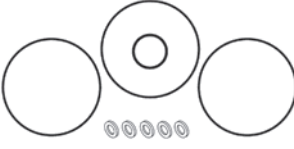
O-Rings	R134a and R-12 Compatible	Green HNBR	Black Nitrile
Body Sensor Port O-Ring		<b>M20-2116</b>	<b>M20-1016</b>
Case O-Ring		<b>M20-2159</b>	<b>M20-1059</b>
Lip Seal O-Ring		<b>M20-2118</b>	<b>M20-1018</b>
Rear Head Sensor Port O-Ring (for C20-2000) (Lexus)		<b>M96-2153</b>	<b>M96-1053</b>
<b>Bearings</b>		<b>Fasteners</b>	
Case Bearing (Front) (16mm x 23mm x 21.9mm)	<b>B10-2110</b>	Clutch Installation Kit	<b>K20-5107</b>
Case Bearing (Rear) (15mm x 23mm x 16mm Hardened)	<b>B20-2000</b>		
Clutch Bearing (30mm x 52mm x 22mm)	<b>B20-1106</b>	<p><i>Includes: Coil Retaining Ring (1), Pulley Retaining Ring (1), Shaft Bolt (1), Shim (0.20mm) (1), Shim (0.38mm) (1), Shim (0.51mm) (1).</i></p>	
Clutch Bearing (30mm x 52mm x 22mm) O.E.	<b>B20-1906</b>	<b>Gaskets</b>	
Thrust Bearing (Early) (17mm x 34mm x 2.4mm)	<b>B20-3127</b>	Gasket - Front Head	Metal <b>G20-2002</b>
Thrust Bearing (Late) (17.3mm x 34mm x 3mm)	<b>B20-3115</b>	Gasket - Rear Head	Metal <b>G20-2003</b>
Thrust Race (Early) (Cylinder Side) (17mm x 34mm x 2.24mm)	<b>B20-4100</b>	Gasket - Suction / Discharge Port	Green HNBR <b>G20-3106</b>
Thrust Race (Early) (Swash Plate Side) (17mm x 37mm x 2.24mm)	<b>B20-4101</b>	Gasket Kit	Green HNBR <b>K20-2160</b>
<b>Chemicals</b>			
Ultra PAG Oil 46 - 6pk, 8 oz Bottle	<b>MT3012</b>	<p><i>Includes: Front Head Gasket (1), Rear Head Gasket (1), Suction/Discharge Port Gasket (1), Head Bolt Washer (5), Case O-Ring (3), Lip Seal O-Ring (1).</i></p>	
Ultra PAG Oil 46 - 6pk, Quart Bottle	<b>MT3018</b>	<b>O-Ring Kit</b>	
Ultra PAG Oil 46 - Drum (52 gal)	<b>A10-6163</b>	<p>Green HNBR <b>K20-2120</b></p> 	
<b>Clutch Components</b>		<p><i>Includes: Head Bolt Washer (5), Case O-Ring (3), Lip Seal O-Ring (1)</i></p>	
Clutch Coil - 12 Volt	<b>H20-7320</b>	<b>Hard Components</b>	
Clutch Coil - 24 Volt	<b>H20-7321</b>	Housing (Head) - Front (10PA20C Mercedes)	<b>H20-1013</b>
Clutch Hub - OD: 102mm	<b>H20-7004</b>	Housing (Head) - Front (10PA20C)	<b>H20-1008</b>
Clutch Pulley - 6 Groove Recessed Face (10PA20C Lexus)	<b>A20-5106</b>	Shaft and Swash Plate (Late) (10PA20C)	<b>H20-5010</b>
<b>Fasteners</b>		Shaft and Swash Plate w/Sensor (Late) (10PA20C/20H)	<b>H20-5011</b>
Bolt - Shaft	<b>F20-2110</b>	<b>Piston Components</b>	
Bolt - Shipping Plate	<b>F11-2100</b>	Ball Shoe 7.890 - 7.895mm	<b>P20-1001</b>
Helical Insert - Rear Head / Shipping Plate (8-1.25 x 12mm)	<b>F10-6211</b>	Ball Shoe 7.895 - 7.900mm	<b>P20-1002</b>
Retaining Ring - Clutch Coil	<b>F13-4123</b>		
Retaining Ring - Lip Seal	<b>F20-4110</b>		
Retaining Ring - Pulley	<b>F12-4110</b>		
Retaining Ring - Pulley	<b>F20-4111</b>		
Retaining Ring - Rear Head Sensor Port	<b>F20-4000</b>		
Shim - Clutch (0.20mm)	<b>F11-3105</b>		
Shim - Clutch (0.38mm)	<b>F12-3110</b>		
Shim - Clutch (0.51mm)	<b>F11-3115</b>		
Washer - Head Bolt	<b>F11-3111</b>		

## DENSO

10PA20, 10PA20C, 10PA20H, 10PA20J

### Piston Components

Ball Shoe 7.900 - 7.905mm	<b>P20-1003</b>
Ball Shoe 7.905 - 7.910mm	<b>P20-1004</b>
Ball Shoe 7.910 - 7.915mm	<b>P20-1005</b>
Ball Shoe 7.915 - 7.920mm	<b>P20-1006</b>
Ball Shoe 7.920 - 7.925mm	<b>P20-1007</b>
Ball Shoe 7.925 - 7.930mm	<b>P20-1008</b>
Ball Shoe 7.930 - 7.935mm	<b>P20-1009</b>
Ball Shoe 7.935 - 7.940mm	<b>P20-1010</b>
Cylinder Piston	<b>P20-4002</b>

### Reeds and Valve Plates

Valve Plate (Rear)	<b>H20-6003</b>
Reed - Discharge Valve	<b>R20-2001</b>

### Service Items

High Pressure Relief Valve	<b>A20-5203</b>
Fitting (Refrigerant) - 1/8" NPT Brass Port w/ Valve	<b>A10-1024</b>

### Shaft Seals

Lip Seal (Black Rubber Coated)	HNBR <b>S20-1006</b>
Lip Seal (Metal Can)	Nitrile <b>S20-1005</b>
Lip Seal Kit (Black Rubber Coated)	Green HNBR <b>K20-3146</b>

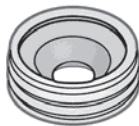

Includes: Lip Seal (1), Lip Seal Retaining Ring (1).

Lip Seal Kit (Can Type)	Green HNBR <b>K20-3147</b>
-------------------------	----------------------------



Includes: Lip Seal (1), Lip Seal Retaining Ring (1).

### Shipping Closures

Plug - Rear Head Sensor Port (Lexus) (use M96-2153)	<b>C20-2000</b>
Shipping Cap - Nose Protector	<b>C20-1000</b>
Shipping Pad (Use with C20-4102)	<b>C20-3102</b>
Shipping Plate (Use with C20-3102)	<b>C20-4102</b>

### Tools

Helical Insert Drill for 8-1.25mm Inserts	<b>T10-6053</b>
Helical Insert Tap 8-1.25mm	<b>T10-6254</b>
Helical Insert Tool 8-1.25mm - Bolt Style	<b>T10-6554</b>
Shaft Seal Installer / Remover (Aftermarket)	<b>T20-3002</b>
Shaft Seal Protector, Adjustable	<b>T95-1227</b>
Shaft Seal Seat Installer / Remover (O.E.)	<b>T60-3001</b>
Helical Insert Repair Kit (8-1.25mm)	<b>K10-1180</b>



Includes: Helical Inserts (25), Drill (1), Tap (1), Installation Tool - Bolt Style (1)



## DENSO 10PA20SC

O-Rings	R134a and R-12 Compatible	Green HNBR	Black Nitrile
Body Sensor Port O-Ring		<b>M20-2116</b>	<b>M20-1016</b>
Case O-Ring		<b>M20-2159</b>	<b>M20-1059</b>
Lip Seal O-Ring		<b>M20-2118</b>	<b>M20-1018</b>

Bearings	
Case Bearing (Front) (16mm x 23mm x 21.9mm)	<b>B10-2110</b>
Case Bearing (Rear) (15mm x 23mm x 16mm Hardened)	<b>B20-2000</b>
Clutch Bearing (30mm x 52mm x 22mm)	<b>B20-1106</b>
Thrust Bearing (Early) (17mm x 34mm x 2.4mm)	<b>B20-3127</b>
Thrust Bearing (Late) (17.3mm x 34mm x 3mm)	<b>B20-3115</b>
Thrust Race (Early) (Cylinder Side) (17mm x 34mm x 2.24mm)	<b>B20-4100</b>
Thrust Race (Early) (Swash Plate Side) (17mm x 37mm x 2.24mm)	<b>B20-4101</b>

Chemicals	
Ultra PAG Oil 46 - 6pk, 8 oz Bottle	<b>MT3012</b>
Ultra PAG Oil 46 - 6pk, Quart Bottle	<b>MT3018</b>
Ultra PAG Oil 46 - Drum (52 gal)	<b>A10-6163</b>

Clutch Components	
Clutch Coil - 12 Volt	<b>H20-7320</b>
Clutch Coil - 24 Volt	<b>H20-7321</b>
Clutch Hub - OD: 102mm	<b>H20-7004</b>

Fasteners	
Bolt - Shaft	<b>F20-2110</b>
Bolt - Shipping Plate	<b>F11-2100</b>
Helical Insert - Rear Head / Shipping Plate (8-1.25 x 12mm)	<b>F10-6211</b>
Retaining Ring - Clutch Coil	<b>F13-4123</b>
Retaining Ring - Lip Seal	<b>F20-4110</b>
Retaining Ring - Pulley	<b>F12-4110</b>
Retaining Ring - Pulley	<b>F20-4111</b>
Shim - Clutch (0.20mm)	<b>F11-3105</b>
Shim - Clutch (0.38mm)	<b>F12-3110</b>
Shim - Clutch (0.51mm)	<b>F11-3115</b>
Washer - Head Bolt	<b>F11-3111</b>

Fasteners	
Clutch Installation Kit	<b>K20-5107</b>



Includes: Coil Retaining Ring (1), Pulley Retaining Ring (1), Shaft Bolt (1), Shim (0.20mm) (1), Shim (0.38mm) (1), Shim (0.51mm) (1).

Gaskets	
Gasket - Front Head	Metal <b>G20-2002</b>
Gasket - Rear Head	Metal <b>G20-2003</b>
Gasket - Suction / Discharge Port	Green HNBR <b>G20-3106</b>
O-Ring Kit	Green HNBR <b>K20-2120</b>

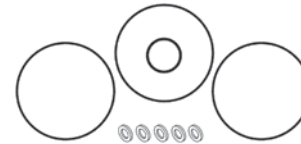

Includes: Head Bolt Washer (5), Case O-Ring (3), Lip Seal O-Ring (1)

Piston Components	
Ball Shoe 7.890 - 7.895mm	<b>P20-1001</b>
Ball Shoe 7.895 - 7.900mm	<b>P20-1002</b>
Ball Shoe 7.900 - 7.905mm	<b>P20-1003</b>
Ball Shoe 7.905 - 7.910mm	<b>P20-1004</b>
Ball Shoe 7.910 - 7.915mm	<b>P20-1005</b>
Ball Shoe 7.915 - 7.920mm	<b>P20-1006</b>
Ball Shoe 7.920 - 7.925mm	<b>P20-1007</b>
Ball Shoe 7.925 - 7.930mm	<b>P20-1008</b>
Ball Shoe 7.930 - 7.935mm	<b>P20-1009</b>
Ball Shoe 7.935 - 7.940mm	<b>P20-1010</b>
Cylinder Piston	<b>P20-4002</b>

Reeds and Valve Plates	
Reed - Discharge Valve	<b>R20-2001</b>

Service Items	
Fitting (Refrigerant) - 1/8" NPT Brass Port w/ Valve	<b>A10-1024</b>

## DENSO 10PA20SC

### Shaft Seals

Lip Seal (Black Rubber Coated)	HNBR <b>S20-1006</b>
Lip Seal (Metal Can)	Nitrile <b>S20-1005</b>
Lip Seal Kit (Black Rubber Coated)	Green HNBR <b>K20-3146</b>



Includes: Lip Seal (1), Lip Seal Retaining Ring (1).

Lip Seal Kit (Can Type)	Green HNBR <b>K20-3147</b>
-------------------------	----------------------------



Includes: Lip Seal (1), Lip Seal Retaining Ring (1).

### Shipping Closures

Shipping Cap - Nose Protector	<b>C20-1000</b>
Shipping Pad (Use with C20-4102)	<b>C20-3102</b>
Shipping Plate (Use with C20-3102)	<b>C20-4102</b>

### Tools

Shaft Seal Installer / Remover (Aftermarket)	<b>T20-3002</b>
Shaft Seal Seat Installer / Remover (O.E.)	<b>T60-3001</b>
Helical Insert Repair Kit (8-1.25mm)	<b>K10-1180</b>



Includes: Helical Inserts (25), Drill (1), Tap (1), Installation Tool - Bolt Style (1)

## DENSO

### 10PA20SH

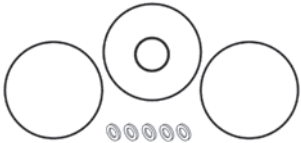
O-Rings	R134a and R-12 Compatible	Green HNBR	Black Nitrile
Case O-Ring		<b>M20-2159</b>	<b>M20-1059</b>
Lip Seal O-Ring		<b>M20-2118</b>	<b>M20-1018</b>
<b>Bearings</b>		<b>Fasteners</b>	
Case Bearing (Front) (16mm x 23mm x 21.9mm)	<b>B10-2110</b>	Clutch Installation Kit <b>K20-5107</b>	
Case Bearing (Rear) (15mm x 23mm x 16mm Hardened)	<b>B20-2000</b>		
Clutch Bearing (30mm x 52mm x 22mm)	<b>B20-1106</b>		
Thrust Bearing (Early) (17mm x 34mm x 2.4mm)	<b>B20-3127</b>	<i>Includes: Coil Retaining Ring (1), Pulley Retaining Ring (1), Shaft Bolt (1), Shim (0.20mm) (1), Shim (0.38mm) (1), Shim (0.51mm) (1).</i>	
Thrust Bearing (Late) (17.3mm x 34mm x 3mm)	<b>B20-3115</b>		
Thrust Race (Early) (Cylinder Side) (17mm x 34mm x 2.24mm)	<b>B20-4100</b>	<b>Gaskets</b>	
Thrust Race (Early) (Swash Plate Side) (17mm x 37mm x 2.24mm)	<b>B20-4101</b>	Gasket - Front Head	Metal <b>G20-2002</b>
<b>Chemicals</b>		Gasket - Rear Head	Metal <b>G20-2003</b>
Ultra PAG Oil 46 - 6pk, 8 oz Bottle	<b>MT3012</b>	Gasket - Suction / Discharge Port	Green HNBR <b>G20-3106</b>
Ultra PAG Oil 46 - 6pk, Quart Bottle	<b>MT3018</b>	O-Ring Kit	Green HNBR <b>K20-2120</b>
Ultra PAG Oil 46 - Drum (52 gal)	<b>A10-6163</b>		
<b>Clutch Components</b>			
Clutch Coil - 12 Volt	<b>H20-7320</b>	<i>Includes: Head Bolt Washer (5), Case O-Ring (3), Lip Seal O-Ring (1)</i>	
Clutch Coil - 24 Volt	<b>H20-7321</b>		
Clutch Hub - OD: 102mm	<b>H20-7004</b>	<b>Piston Components</b>	
<b>Fasteners</b>		Ball Shoe 7.890 - 7.895mm	<b>P20-1001</b>
Bolt - Shaft	<b>F20-2110</b>	Ball Shoe 7.895 - 7.900mm	<b>P20-1002</b>
Bolt - Shipping Plate	<b>F11-2100</b>	Ball Shoe 7.900 - 7.905mm	<b>P20-1003</b>
Helical Insert - Rear Head / Shipping Plate (8-1.25 x 12mm)	<b>F10-6211</b>	Ball Shoe 7.905 - 7.910mm	<b>P20-1004</b>
Retaining Ring - Clutch Coil	<b>F13-4123</b>	Ball Shoe 7.910 - 7.915mm	<b>P20-1005</b>
Retaining Ring - Lip Seal	<b>F20-4110</b>	Ball Shoe 7.915 - 7.920mm	<b>P20-1006</b>
Retaining Ring - Pulley	<b>F12-4110</b>	Ball Shoe 7.920 - 7.925mm	<b>P20-1007</b>
Retaining Ring - Pulley	<b>F20-4111</b>	Ball Shoe 7.925 - 7.930mm	<b>P20-1008</b>
Shim - Clutch (0.20mm)	<b>F11-3105</b>	Ball Shoe 7.930 - 7.935mm	<b>P20-1009</b>
Shim - Clutch (0.38mm)	<b>F12-3110</b>	Ball Shoe 7.935 - 7.940mm	<b>P20-1010</b>
Shim - Clutch (0.51mm)	<b>F11-3115</b>	Cylinder Piston	<b>P20-4002</b>
Washer - Head Bolt	<b>F11-3111</b>	<b>Reeds and Valve Plates</b>	
		Reed - Discharge Valve	<b>R20-2001</b>
		<b>Service Items</b>	
		Fitting (Refrigerant) - 1/8" NPT Brass Port w/ Valve	<b>A10-1024</b>

## DENSO 10PA20SH

### Shaft Seals

Lip Seal (Black Rubber Coated)	HNBR <b>S20-1006</b>
Lip Seal (Metal Can)	Nitrile <b>S20-1005</b>
Lip Seal Kit (Black Rubber Coated)	Green HNBR <b>K20-3146</b>



Includes: Lip Seal (1), Lip Seal Retaining Ring (1).

Lip Seal Kit (Can Type)	Green HNBR <b>K20-3147</b>
-------------------------	----------------------------



Includes: Lip Seal (1), Lip Seal Retaining Ring (1).

### Shipping Closures

Shipping Cap - Nose Protector	<b>C20-1000</b>
Shipping Pad (Use with C20-4102)	<b>C20-3102</b>
Shipping Plate (Use with C20-3102)	<b>C20-4102</b>

### Tools

Shaft Seal Installer / Remover (Aftermarket)	<b>T20-3002</b>
Shaft Seal Seat Installer / Remover (O.E.)	<b>T60-3001</b>
Helical Insert Repair Kit (8-1.25mm)	<b>K10-1180</b>



Includes: Helical Inserts (25), Drill (1), Tap (1), Installation Tool - Bolt Style (1)

## DENSO

### 10PA20VC

O-Rings	R134a and R-12 Compatible	Green HNBR	Black Nitrile
Case O-Ring		<b>M20-2159</b>	<b>M20-1059</b>
Lip Seal O-Ring		<b>M20-2118</b>	<b>M20-1018</b>
Bearings		Fasteners	
Case Bearing (Front) (16mm x 23mm x 21.9mm)	<b>B10-2110</b>	Clutch Installation Kit	<b>K20-5107</b>
Case Bearing (Rear) (15mm x 23mm x 16mm Hardened)	<b>B20-2000</b>		
Clutch Bearing (30mm x 52mm x 22mm)	<b>B20-1106</b>		
Thrust Bearing (Early) (17mm x 34mm x 2.4mm)	<b>B20-3127</b>	<p><i>Includes: Coil Retaining Ring (1), Pulley Retaining Ring (1), Shaft Bolt (1), Shim (0.20mm) (1), Shim (0.38mm) (1), Shim (0.51mm) (1).</i></p>	
Thrust Bearing (Late) (17.3mm x 34mm x 3mm)	<b>B20-3115</b>	Gaskets	
Thrust Race (Early) (Cylinder Side) (17mm x 34mm x 2.24mm)	<b>B20-4100</b>	Gasket - Front Head	Metal <b>G20-2002</b>
Thrust Race (Early) (Swash Plate Side) (17mm x 37mm x 2.24mm)	<b>B20-4101</b>	Gasket - Suction / Discharge Port	Green HNBR <b>G20-3106</b>
Chemicals		Piston Components	
Ultra PAG Oil 46 - 6pk, 8 oz Bottle	<b>MT3012</b>	Ball Shoe 7.890 - 7.895mm	<b>P20-1001</b>
Ultra PAG Oil 46 - 6pk, Quart Bottle	<b>MT3018</b>	Ball Shoe 7.895 - 7.900mm	<b>P20-1002</b>
Ultra PAG Oil 46 - Drum (52 gal)	<b>A10-6163</b>	Ball Shoe 7.900 - 7.905mm	<b>P20-1003</b>
Clutch Components		Ball Shoe 7.905 - 7.910mm	<b>P20-1004</b>
Clutch Coil - 12 Volt	<b>H20-7320</b>	Ball Shoe 7.910 - 7.915mm	<b>P20-1005</b>
Clutch Coil - 24 Volt	<b>H20-7321</b>	Ball Shoe 7.915 - 7.920mm	<b>P20-1006</b>
Clutch Hub - OD: 102mm	<b>H20-7004</b>	Ball Shoe 7.920 - 7.925mm	<b>P20-1007</b>
Fasteners		Ball Shoe 7.925 - 7.930mm	<b>P20-1008</b>
Bolt - Shaft	<b>F20-2110</b>	Ball Shoe 7.930 - 7.935mm	<b>P20-1009</b>
Bolt - Shipping Plate	<b>F11-2100</b>	Ball Shoe 7.935 - 7.940mm	<b>P20-1010</b>
Helical Insert - Rear Head / Shipping Plate (8-1.25 x 12mm)	<b>F10-6211</b>	Cylinder Piston	<b>P20-4002</b>
Retaining Ring - Clutch Coil	<b>F13-4123</b>	Reeds and Valve Plates	
Retaining Ring - Lip Seal	<b>F20-4110</b>	Reed - Discharge Valve (Front)	<b>R20-2001</b>
Retaining Ring - Pulley	<b>F12-4110</b>	Service Items	
Retaining Ring - Pulley	<b>F20-4111</b>	Fitting (Refrigerant) - 1/8" NPT Brass Port w/ Valve	<b>A10-1024</b>
Shim - Clutch (0.20mm)	<b>F11-3105</b>	Shaft Seals	
Shim - Clutch (0.38mm)	<b>F12-3110</b>	Lip Seal (Black Rubber Coated)	HNBR <b>S20-1006</b>
Shim - Clutch (0.51mm)	<b>F11-3115</b>	Lip Seal (Metal Can)	Nitrile <b>S20-1005</b>
Washer - Head Bolt	<b>F11-3111</b>		



## DENSO 10PA20VC

### Shaft Seals

Lip Seal Kit (Black Rubber Coated)      Green HNBR **K20-3146**



*Includes: Lip Seal (1), Lip Seal Retaining Ring (1).*

Lip Seal Kit (Can Type)      Green HNBR **K20-3147**



*Includes: Lip Seal (1), Lip Seal Retaining Ring (1).*

### Shipping Closures

Shipping Cap - Nose Protector      **C20-1000**  
Shipping Pad (Use with C20-4102)      **C20-3102**  
Shipping Plate (Use with C20-3102)      **C20-4102**

### Tools

Shaft Seal Installer / Remover (Aftermarket)      **T20-3002**  
Shaft Seal Protector, Adjustable      **T95-1227**  
Shaft Seal Seat Installer / Remover (O.E.)      **T60-3001**  
Helical Insert Repair Kit (8-1.25mm)      **K10-1180**



*Includes: Helical Inserts (25), Drill (1), Tap (1), Installation Tool - Bolt Style (1)*

## DENSO

10S11C, 10S11P, 10S13C, 10S13P

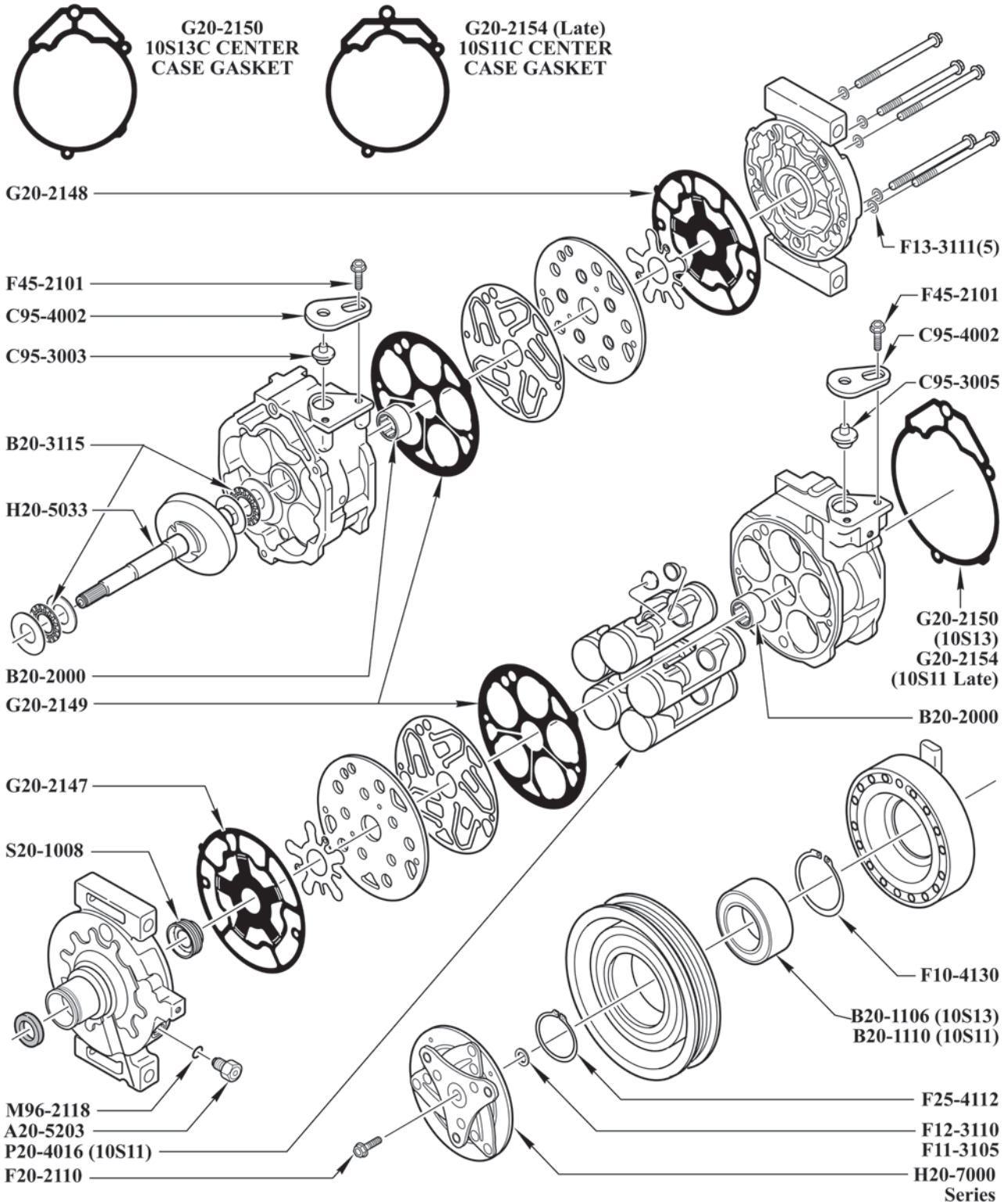

## DENSO

### 10S11C, 10S11P, 10S13C, 10S13P

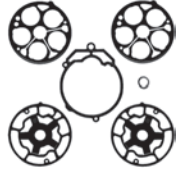
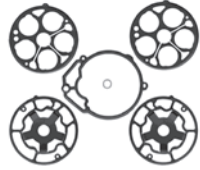
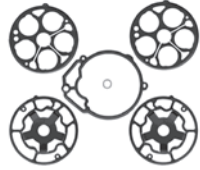
O-Rings	R134a and R-12 Compatible	Green HNBR	Black Nitrile		
High Pressure Relief Valve O-Ring		<b>M96-2118</b>	<b>M96-1018</b>		
Suction Port O-Ring (Jeep Only)		<b>M20-2160</b>			
<b>Bearings</b>		<b>Gaskets</b>			
Case Bearing (15mm x 23mm x 16mm Hardened)	<b>B20-2000</b>	Gasket - Center Case(10S13C/10S13P)	Metal <b>G20-2150</b>		
Clutch Bearing (30mm x 52mm x 22mm) (10S11)	<b>B20-1110</b>	Gasket - Cylinder	Metal <b>G20-2149</b>		
Clutch Bearing (30mm x 52mm x 22mm) (10S13)	<b>B20-1106</b>	Gasket - Front Head	Metal <b>G20-2147</b>		
Thrust Bearing (17.3mm x 34mm x 3mm)	<b>B20-3115</b>	Gasket - Rear Head	Metal <b>G20-2148</b>		
<b>Chemicals</b>		Gasket - Center Case	Fiber <b>G20-1350</b>		
Ultra PAG Oil 46 - 6pk, 8 oz Bottle	<b>MT3012</b>	Gasket - Center Case - Early Model	Fiber <b>G20-1355</b>		
Ultra PAG Oil 46 - 6pk, Quart Bottle	<b>MT3018</b>	Gasket - Center Case - Late Model	Fiber <b>G20-1354</b>		
Ultra PAG Oil 46 - Drum (52 gal)	<b>A10-6163</b>	Gasket - Cylinder	Fiber <b>G20-1349</b>		
<b>Clutch Components</b>		Gasket Kit (Metal)(Late 10S11)	Green HNBR <b>K20-2169</b>		
Clutch Coil - OD/ID: 86.9mm / 59.6mm	<b>H20-7304</b>	 <p><i>Includes: Cylinder Gasket (1), Front Valve Plate Gasket (1), Rear Valve Plate Gasket (1) Center Gasket (1), High Pressure Relief Valve O-Ring (1).</i></p>			
Clutch Coil - OD/ID: 87mm / 59.6mm (Toyota Echo/Yaris)	<b>H20-7300</b>				
Clutch Coil - OD/ID: 96.4mm / 61mm Tercell,Suzuki,Chvy Trk	<b>H20-7301</b>				
Clutch Hub - OD: 102mm	<b>H20-7004</b>				
Clutch Hub - OD: 88mm	<b>H20-7002</b>				
Clutch Hub - OD: 92.5mm	<b>H20-7001</b>	 <p><i>Includes: Cylinder Gasket (1), Front Valve Plate Gasket (1), Rear Valve Plate Gasket (1), Center Gasket (1), High Pressure Relief Valve O-Ring (1).</i></p>			
Clutch Pulley - 6 Groove w/ Bearing (146mm)	<b>H20-7708</b>				
Clutch Pulley - 6 Groove w/ Bearing (152mm)	<b>H20-7706</b>				
<b>Electrical</b>				<b>Gasket Kit (Metal)-10S13</b> Green HNBR <b>K20-2170</b>	
Chrysler Coil Wiring Harness	<b>E20-4003</b>			 <p><i>Includes: Cylinder Gasket (1), Front Valve Plate Gasket (1), Rear Valve Plate Gasket (1), Center Gasket (1), High Pressure Relief Valve O-Ring (1).</i></p>	
Clutch Coil Pigtail - 2-Pin	<b>E11-4004</b>				
GM Coil Wiring Harness	<b>E20-4004</b>				
<b>Fasteners</b>		<b>Hard Components</b>			
Bolt - Shaft	<b>F20-2110</b>	10S11 Swash Plate	<b>H20-5042</b>		
Bolt - Shipping Plate	<b>F45-2101</b>	10S11 Swash Plate with Shaft	<b>H20-5046</b>		
Retaining Ring - Coil	<b>F10-4130</b>	Cylinder Assembly (Reman - Sold w/o Warranty)	<b>H20-4526</b>		
Retaining Ring - Pulley	<b>F25-4112</b>	<b>Piston Components</b>			
Shim - Clutch (0.20mm)	<b>F11-3105</b>	10S11 Piston	<b>P20-4016</b>		
Shim - Clutch (0.38mm)	<b>F12-3110</b>	<b>Service Items</b>			
Shim - Clutch (0.51mm)	<b>F11-3115</b>	High Pressure Relief Valve	<b>A20-5203</b>		
Washer - Head Bolt	<b>F13-3111</b>				
<b>Gaskets</b>					
Gasket - Center Case (10S11C/10S11P) (Late Models)	Metal <b>G20-2154</b>				

## DENSO

10S11C, 10S11P, 10S13C, 10S13P

### Shaft Seals

Lip Seal (Black Rubber Coated) **HNBR S20-1008**

Lip Seal Kit **Green HNBR K20-3148**



*Includes: Lip Seal (1).*

### Shipping Closures

Green Plastic Plug **C20-5004**

Green Plastic Plug **C20-5005**

Plug - Aluminum Dummy **C13-2111**

Shipping Cap - Nose Protector **C20-1000**

Shipping Pad (Use with C50-4101) **C50-3001**

Shipping Plate (Use with C50-3001) **C50-4101**

Shipping Plate (Use with C95-3003 & C95-3005) **C95-4002**

Shipping Plug (Discharge) (Use with C95-4002) **C95-3003**

Shipping Plug (Suction) (Use with C95-4002) **C95-3005**

### Tools

Shaft Seal Protector, Adjustable **T95-1227**



## DENSO

10S15C, 10S15L, 10S17C, 10S17F, 10S20C, 10S20F, 10S20H

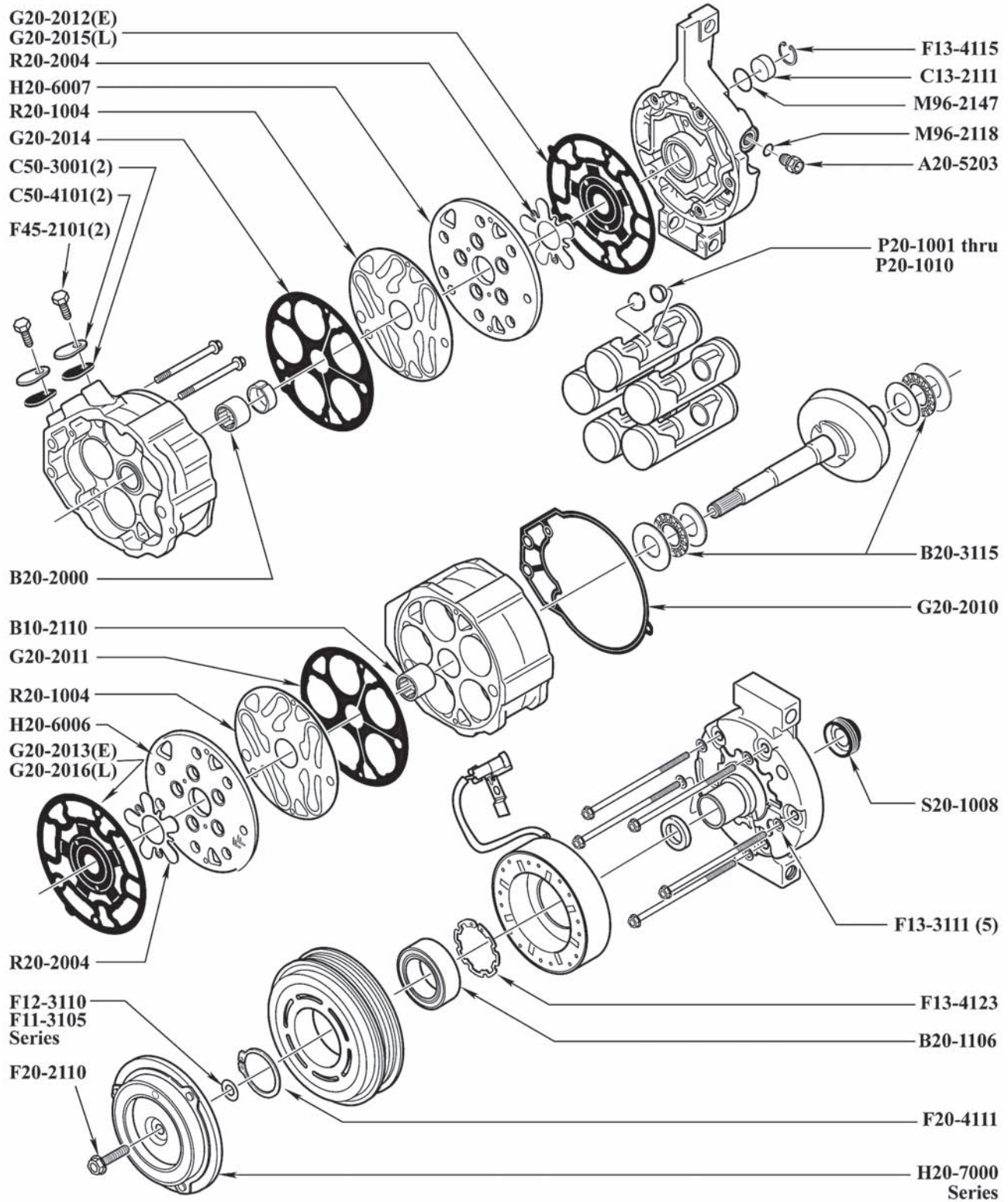

## DENSO

10S15C, 10S15L, 10S17C, 10S17F, 10S20C, 10S20F, 10S20H

O-Rings	R134a and R-12 Compatible	Green HNBR	Black Nitrile
Body Sensor Port O-Ring		<b>M20-2116</b>	<b>M20-1016</b>
Control Valve Mount / High PSI Relief Valve O-Ring		<b>M96-2118</b>	<b>M96-1018</b>
Discharge Port O-Ring (use with G11-2165)		<b>M10-2110</b>	<b>M10-1010</b>
High Pressure Relief Valve O-Ring		<b>M96-2118</b>	<b>M96-1018</b>
Pressure Switch O-Ring		<b>M96-2147</b>	
Suction Port O-Ring (use with G11-2165)		<b>M11-2111</b>	
Suction Port O-Ring (use with G11-2166) (Jeep Only)		<b>M20-2160</b>	
Bearings		Fasteners	
Case Bearing (16mm x 23mm x 21.9mm) (10P15)	<b>B10-2110</b>	Retaining Ring - Pulley	<b>F12-4110</b>
Case Bearing (Front) (16mm x 23mm x 21.9mm)	<b>B10-2110</b>	Retaining Ring - Pulley	<b>F20-4111</b>
Case Bearing (Rear) (15mm x 23mm x 16mm Hardened)	<b>B20-2000</b>	Retaining Ring - Switch Port	<b>F13-4115</b>
Clutch Bearing (30mm x 52mm x 22mm)	<b>B20-1106</b>	Washer - Head Bolt	<b>F13-4123</b>
Clutch Bearing (30mm x 52mm x 22mm) O.E.	<b>B20-1906</b>	Shim - Clutch (0.20mm)	<b>F11-3105</b>
Thrust Bearing (17.3mm x 34mm x 3mm)	<b>B20-3115</b>	Shim - Clutch (0.38mm)	<b>F12-3110</b>
Chemicals		Shim - Clutch (0.51mm)	<b>F11-3115</b>
Ultra PAG Oil 46 - 6pk, 8 oz Bottle	<b>MT3012</b>	Washer - Head Bolt	<b>F13-3111</b>
Ultra PAG Oil 46 - 6pk, Quart Bottle	<b>MT3018</b>	Clutch Installation Kit	<b>K20-5107</b>
Ultra PAG Oil 46 - Drum (52 gal)	<b>A10-6163</b>		
Clutch Components			
Clutch Assembly (Dodge Caravan 3.3L 07-05)	<b>H20-7901</b>		
Clutch Coil - 12 Volt (GM)	<b>H20-7332</b>		
Clutch Coil - OD/ID: 96.4mm / 61mm Honda	<b>H20-7303</b>		
Clutch Hub - OD: 102mm	<b>H20-7004</b>		
Clutch Hub - OD: 102mm	<b>H20-7006</b>		
Clutch Hub - OD: 88mm	<b>H20-7002</b>		
Clutch Hub - OD: 92.5mm	<b>H20-7001</b>		
Clutch Pulley - 6 Groove w/ Bearing (135mm)	<b>H20-7722</b>		
Electrical		Gaskets	
Chrysler Coil Wiring Harness	<b>E20-4003</b>	Gasket - Center Case	Metal <b>G20-2010</b>
Clutch Coil Pigtail - 2-Pin	<b>E11-4004</b>	Gasket - Center Case (BMW Only)	Metal <b>G20-2017</b>
GM Coil Wiring Harness	<b>E20-4004</b>	Gasket - Cylinder - Front	Metal <b>G20-2011</b>
High Pressure Cut-Off Switch (Red Oval)	<b>E96-5167</b>	Gasket - Cylinder - Rear	Metal <b>G20-2014</b>
High Pressure Switch Connector (Red Oval)	<b>E13-1032</b>	Gasket - Discharge Port (requires M11-2110)	Metal <b>G11-2164</b>
High Pressure Cut-Off Switch (Green Oval)	<b>E20-1040</b>	Gasket - Front Head (Early Models)	Metal <b>G20-2013</b>
Fasteners		Gasket - Front Head (Late Models)	Metal <b>G20-2016</b>
Bolt - Housing	<b>F20-2114</b>	Gasket - Rear Head (Early Models)	Metal <b>G20-2012</b>
Bolt - Muffler	<b>F20-2116</b>	Gasket - Rear Head (Late Models)	Metal <b>G20-2015</b>
Bolt - Shaft	<b>F20-2110</b>	Gasket - Suction Port (requires M10-2111)	Metal <b>G11-2165</b>
Bolt - Shipping Plate	<b>F45-2101</b>		
Retaining Ring - Clutch Coil	<b>F13-4123</b>		



Includes: Coil Retaining Ring (1), Pulley Retaining Ring (1), Shaft Bolt (1), Shim (0.20mm) (1), Shim (0.38mm) (1), Shim (0.51mm) (1).

## DENSO

10S15C, 10S15L, 10S17C, 10S17F, 10S20C, 10S20F, 10S20H

### Gaskets

Gasket - Suction Port  
(requires M20-2160 Jeep  
Only) Metal **G11-2166**

Discharge Gasket Kit (Metal) Green HNBR **K11-2117**



Includes: Discharge Gasket (1), Discharge O-Ring (1).

Gasket Kit (Metal) Black Nitrile **K20-2061**

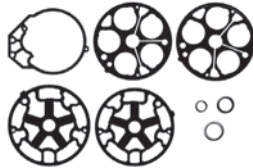

Includes: Center Case Gasket (1), Cylinder Gasket (2), Rear Head Gasket (1), Front Head Gasket (1), Body Sensor Port O-Ring, (1), Pressure Relief Valve O-Ring (1), Pressure Sensor O-Ring (1).

Gasket Kit (Metal) (Early) Green HNBR **K20-2161**



Includes: Center Case Gasket (1), Cylinder Gasket (2), Rear Head Gasket (1), Front Head Gasket (1), Body Sensor Port O-Ring, (1), Pressure Relief Valve O-Ring (1), Pressure Sensor O-Ring (1).

Gasket Kit (Metal)(Late) Black Nitrile **K20-2067**

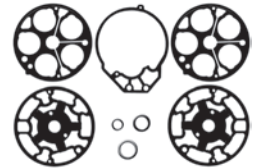

Includes: Center Case Gasket (1), Cylinder Gasket (2), Rear Head Gasket (1), Front Head Gasket (1), Body Sensor Port O-Ring, (1), Pressure Relief Valve O-Ring (1), Pressure Sensor O-Ring (1).

### Gaskets

Gasket Kit (Metal)(Late) Green HNBR **K20-2167**



Includes: Center Case Gasket (1), Cylinder Gasket (2), Rear Head Gasket (1), Front Head Gasket (1), Body Sensor Port O-Ring, (1), Pressure Relief Valve O-Ring (1), Pressure Sensor O-Ring (1).

Suction / Discharge Gasket Kit (Metal) Green HNBR **K11-2118**



Includes: Discharge Gasket (1), Discharge O-Ring (1), Suction Gasket (1), Suction O-Ring (1).

Suction Gasket Kit (Metal) Green HNBR **K11-2116**



Includes: Suction Gasket (1), Suction O-Ring (1).

Suction Gasket Kit (Metal) (Jeep Only) Green HNBR **K11-2119**



Includes: Suction Gasket (1), Suction O-Ring (1).

### Hard Components

10S15 Swash Plate	<b>H20-5043</b>
10S15 Swash Plate with Shaft	<b>H20-5047</b>
10S17 Swash Plate	<b>H20-5044</b>
10S17 Swash Plate with Shaft	<b>H20-5048</b>
10S20 Swash Plate	<b>H20-5045</b>
10S20 Swash Plate with Shaft	<b>H20-5049</b>

### Piston Components

10S15 Piston	<b>P20-4017</b>
--------------	-----------------



## DENSO

10S15C, 10S15L, 10S17C, 10S17F, 10S20C, 10S20F, 10S20H

### Piston Components

10S17 Piston	<b>P20-4018</b>
10S20 Piston	<b>P20-4019</b>
Ball Shoe 7.890 - 7.895mm	<b>P20-1001</b>
Ball Shoe 7.895 - 7.900mm	<b>P20-1002</b>
Ball Shoe 7.900 - 7.905mm	<b>P20-1003</b>
Ball Shoe 7.905 - 7.910mm	<b>P20-1004</b>
Ball Shoe 7.910 - 7.915mm	<b>P20-1005</b>
Ball Shoe 7.915 - 7.920mm	<b>P20-1006</b>
Ball Shoe 7.920 - 7.925mm	<b>P20-1007</b>
Ball Shoe 7.925 - 7.930mm	<b>P20-1008</b>
Ball Shoe 7.930 - 7.935mm	<b>P20-1009</b>
Ball Shoe 7.930 - 7.935mm	<b>P20-1010</b>
Ball Shoe 7.935 - 7.940mm	<b>P20-1010</b>

### Reeds and Valve Plates

Valve Plate (Front)	<b>H20-6006</b>
Valve Plate (Rear)	<b>H20-6007</b>
Reed - Discharge Valve	<b>R20-2004</b>
Reed - Suction Valve	<b>R20-1004</b>

### Service Items

High Pressure Relief Valve	<b>A20-5203</b>
Fitting (Refrigerant) - 1/8" NPT Brass Port w/ Valve	<b>A10-1024</b>
Discharge Sealing Washer and O-Ring Kit	Green HNBR <b>K11-2108</b>



Includes: Discharge Sealing Washer (1), Discharge O-Ring (1).

Suction Sealing Washer and O-Ring Kit	Green HNBR <b>K11-2109</b>
---------------------------------------	----------------------------



Includes: Suction Sealing Washer (1), Suction O-Ring (1).

### Shaft Seals

Lip Seal Kit	Green HNBR <b>K20-3148</b>
--------------	----------------------------



Includes: Lip Seal (1).

### Shipping Closures

Green Plastic Plug	<b>C20-5004</b>
Green Plastic Plug	<b>C20-5005</b>
Plug - Aluminum Dummy	<b>C13-2111</b>
Shipping Cap - Nose Protector	<b>C20-1000</b>
Shipping Pad (Use with C50-4101)	<b>C50-3001</b>
Shipping Plate (Use with C50-3001)	<b>C50-4101</b>
Shipping Plate (Use with C95-3003 & C95-3005)	<b>C95-4002</b>
Shipping Plug (Discharge) (Use with C95-4002)	<b>C95-3003</b>
Shipping Plug (Suction) (Use with C95-4002)	<b>C95-3005</b>

### Tools

Shaft Seal Protector, Adjustable	<b>T95-1227</b>
----------------------------------	-----------------

### Shaft Seals

Lip Seal (Black Rubber Coated)	HNBR <b>S20-1008</b>
--------------------------------	----------------------

## DENSO

### 10SR15C, 10SR17C

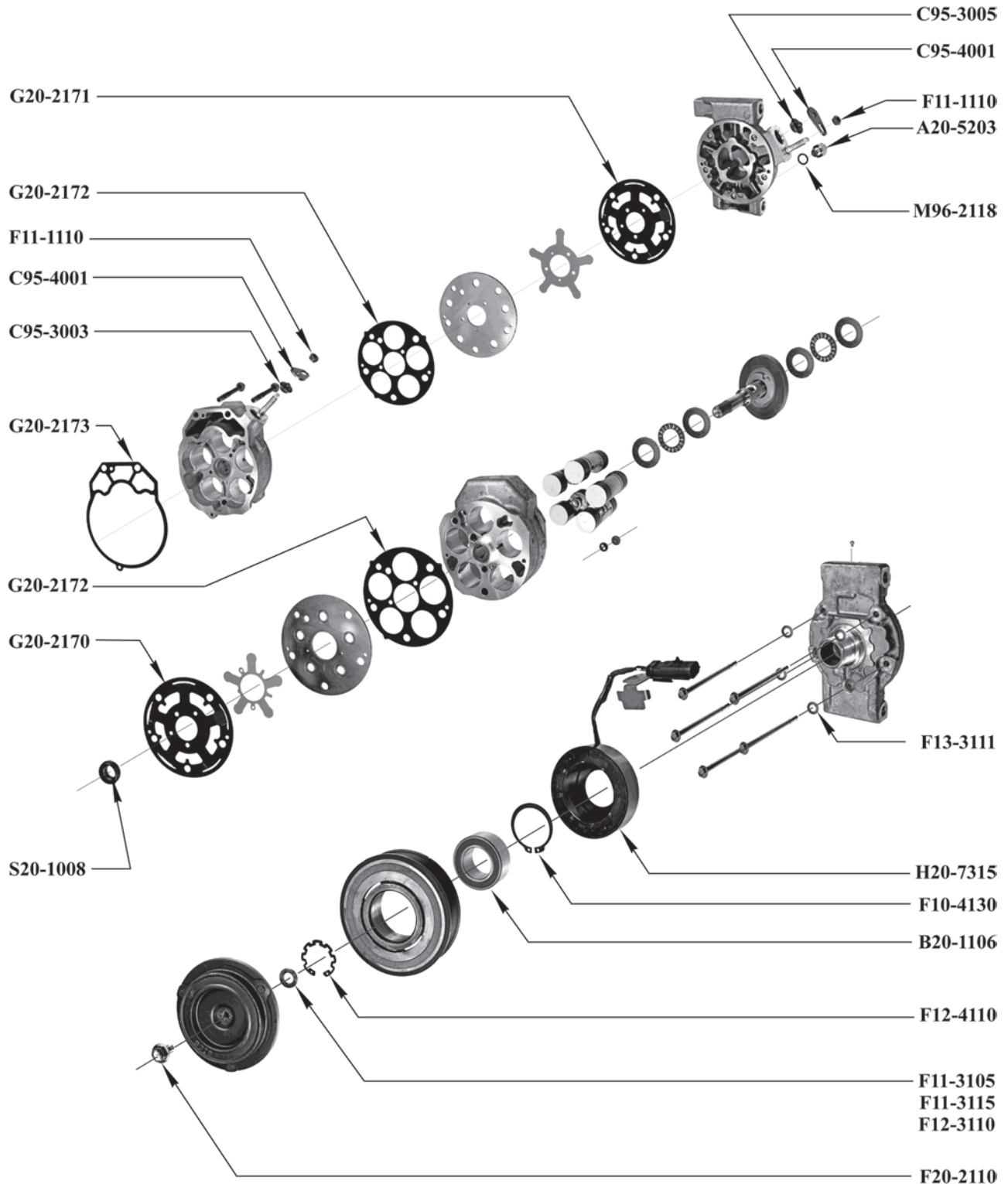

## DENSO

### 10SR15C, 10SR17C

O-Rings	R134a and R-12 Compatible	Green HNBR	Black Nitrile
High Pressure Relief Valve O-Ring		M96-2118	M96-1018
<b>Bearings</b>			
Clutch Bearing (30mm x 52mm x 22mm)	B20-1106		
<b>Chemicals</b>			
Ultra PAG Oil 46 - 6pk, 8 oz Bottle	MT3012		
Ultra PAG Oil 46 - 6pk, Quart Bottle	MT3018		
Ultra PAG Oil 46 - Drum (52 gal)	A10-6163		
<b>Clutch Components</b>			
Clutch Coil - OD/ID: 96.6mm / 61.6mm	H20-7315		
<b>Fasteners</b>			
Bolt - Shaft	F20-2110		
Nut - Shipping Plate	F11-1110		
Retaining Ring - Coil	F10-4130		
Retaining Ring - Pulley	F12-4110		
Shim - Clutch (0.20mm)	F11-3105		
Shim - Clutch (0.38mm)	F12-3110		
Shim - Clutch (0.51mm)	F11-3115		
Washer - Head Bolt	F13-3111		
<b>Gaskets</b>			
Gasket - 10SR Center Housing	Metal G20-2173		
Gasket - 10SR Front Head	Metal G20-2170		
Gasket - 10SR Front/Rear Cylinder	Metal G20-2172		
Gasket - 10SR Rear Head	Metal G20-2171		
<b>Service Items</b>			
High Pressure Relief Valve	A20-5203		
<b>Shaft Seals</b>			
Lip Seal (Black Rubber Coated)	HNBR S20-1008		
<b>Shipping Closures</b>			
Shipping Plate (Use with C95-3003 & C95- 3005)	C95-4001		
Shipping Plug (Discharge) (Use with C95- 4001)	C95-3003		
Shipping Plug (Suction) (Use with C95-4001)	C95-3005		

## **DENSO**

**SC06SA, SCS06C**

## DENSO

### SC06SA, SCS06C

O-Rings	R134a and R-12 Compatible	Green HNBR	Black Nitrile
Case O-Ring			<b>M45-1006</b>
Discharge Port O-Ring		<b>M95-2107</b>	<b>M95-1007</b>
High Pressure Relief Valve O-Ring		<b>M96-2118</b>	<b>M96-1018</b>
<b>Bearings</b>			
Clutch Bearing (30mm x 47mm x 12mm)	<b>B20-1113</b>		
Clutch Bearing (30mm x 47mm x 20mm) (Early Fiat)	<b>B20-1112</b>		
Clutch Bearing (30mm x 52mm x 20mm)	<b>B20-1110</b>		
<b>Chemicals</b>			
Ultra PAG Oil 46 - 6pk, 8 oz Bottle	<b>MT3012</b>		
Ultra PAG Oil 46 - 6pk, Quart Bottle	<b>MT3018</b>		
Ultra PAG Oil 46 - Drum (52 gal)	<b>A10-6163</b>		
<b>Clutch Components</b>			
Clutch Coil - OD/ID: 87mm / 59.6mm (Toyota Echo/Yaris)	<b>H20-7300</b>		
<b>Fasteners</b>			
Bolt - Shaft	<b>F20-2110</b>		
Bolt - Shipping Plate	<b>F45-2101</b>		
Retaining Ring - Coil	<b>F10-4130</b>		
Retaining Ring - Lip Seal	<b>F25-4111</b>		
<b>Service Items</b>			
High Pressure Relief Valve	<b>A20-5203</b>		
<b>Shaft Seals</b>			
Lip Seal (Black Rubber Coated)	HNBR <b>S30-1110</b>		
<b>Shipping Closures</b>			
Shipping Plate (Use with C95-3003 & C95-3005)	<b>C95-4002</b>		
Shipping Plug (Discharge) (Use with C95-4002)	<b>C95-3003</b>		
Shipping Plug (Suction) (Use with C95-4002)	<b>C95-3005</b>		
<b>Tools</b>			
Shaft Seal Protector, Adjustable	<b>T95-1229</b>		

## DENSO

SC08 (ITALY), SC08C (SPAIN), SC08C (USA)

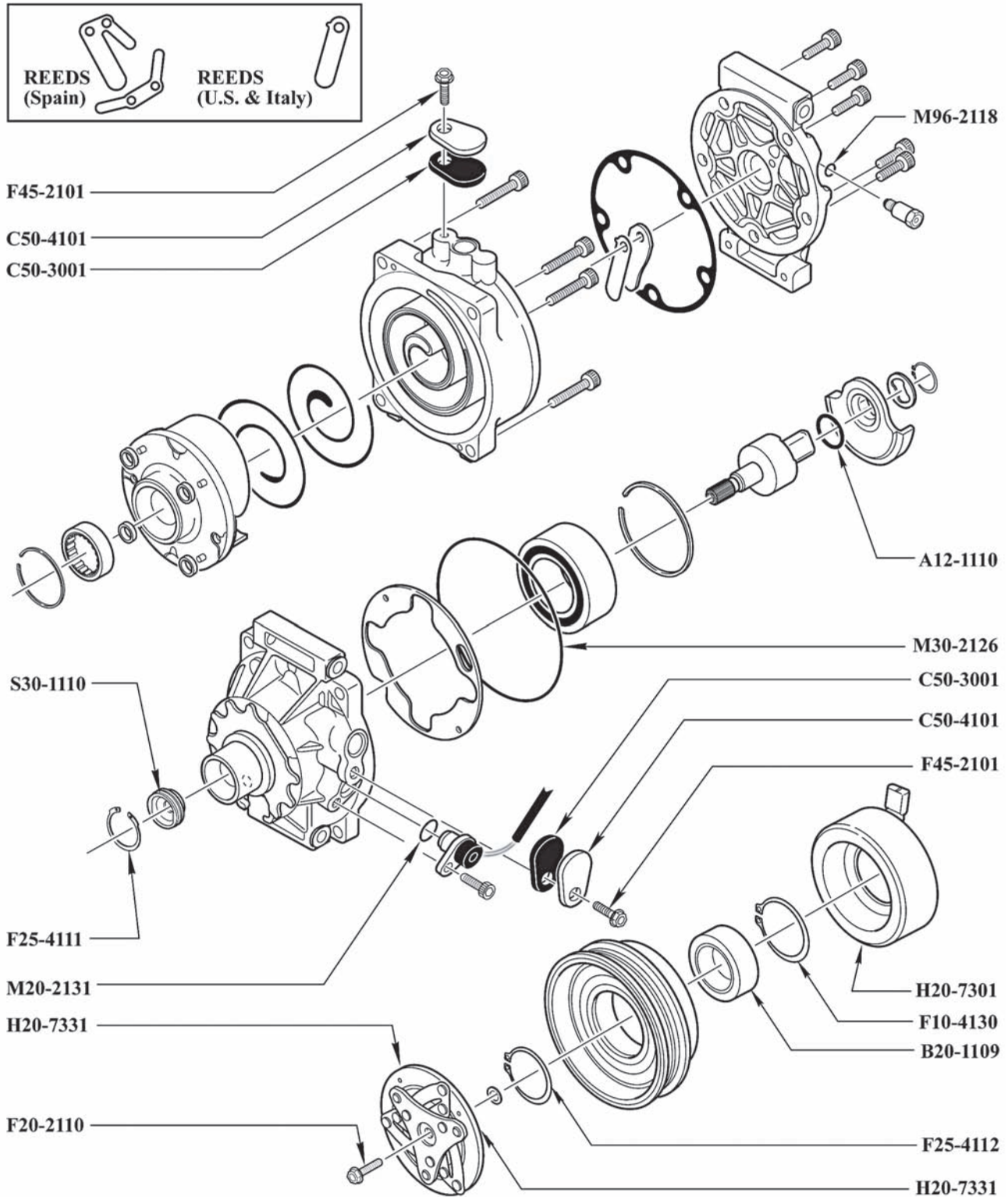

## DENSO

SC08 (ITALY), SC08C (SPAIN), SC08C (USA)

O-Rings	R134a and R-12 Compatible	Green HNBR	Black Nitrile
Case O-Ring		M30-2126	
Eccentric Oval O-Ring		A12-1110	
High Pressure Relief Valve O-Ring		M96-2118	M96-1018
Temperature Switch O-Ring		M20-2131	
<b>Bearings</b>			
Clutch Bearing (35mm x 52mm x 20mm)	B20-1109		
<b>Chemicals</b>			
Ultra PAG Oil 46 - 6pk, 8 oz Bottle	MT3012		
Ultra PAG Oil 46 - 6pk, Quart Bottle	MT3018		
Ultra PAG Oil 46 - Drum (52 gal)	A10-6163		
<b>Clutch Components</b>			
Clutch Coil - OD/ID: 96.4mm / 61mm Tercell,Suzuki,Chvy Trk	H20-7301		
Clutch Hub - OD: 92.5mm (04-00 Toyota Echo 1.5)	H20-7331		
<b>Fasteners</b>			
Bolt - Shaft	F20-2110		
Bolt - Shipping Plate	F45-2101		
Retaining Ring - Clutch Pulley	F25-4112		
Retaining Ring - Coil	F10-4130		
Retaining Ring - Lip Seal	F25-4111		
<b>Shaft Seals</b>			
Lip Seal (Black Rubber Coated)	HNBR S30-1110		
<b>Shipping Closures</b>			
Shipping Pad (Use with C50-4101)	C50-3001		
Shipping Plate (Use with C50-3001)	C50-4101		
Shipping Plate (Use with C95- 3003/3004/3005/3006)	C95-4002		
Shipping Plug (Discharge) (Use with C95- 4002) (Italy)	C95-3003		
Shipping Plug (Discharge) (Use with C95- 4002) (USA/Spain)	C95-3004		
Shipping Plug (Suction) (Use with C95-4002) (Spain)	C95-3006		
Shipping Plug (Suction) (Use with C95-4002) (USA/Italy)	C95-3005		
<b>Tools</b>			
Shaft Seal Protector, Adjustable	T95-1227		

## DENSO

### SCSA06, SCSC06

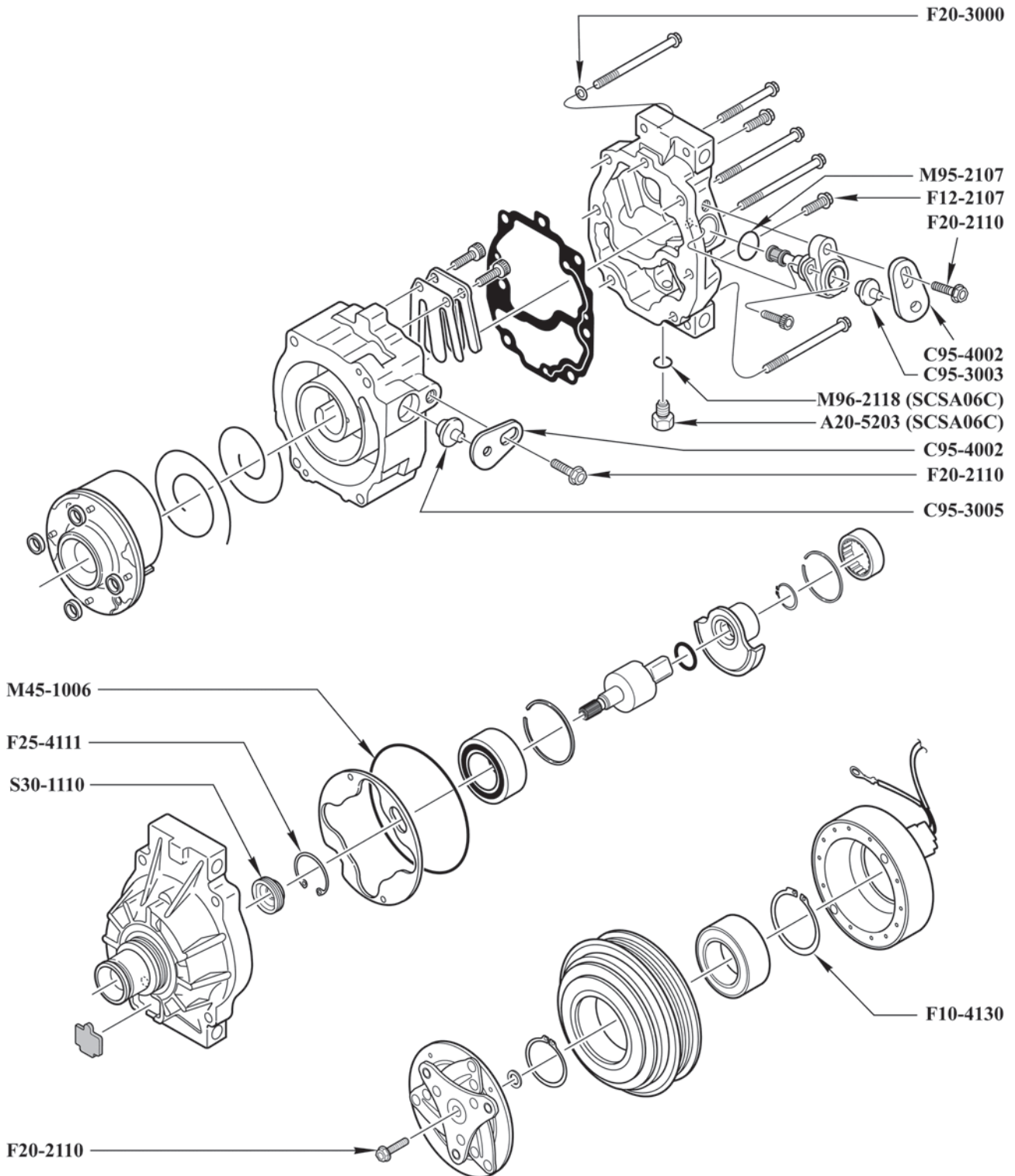



## DENSO

### SCSA06, SCSC06

O-Rings	R134a and R-12 Compatible	Green HNBR	Black Nitrile
Case O-Ring			<b>M45-1006</b>
Discharge Manifold O-Ring		<b>M95-2107</b>	<b>M95-1007</b>
High Pressure Relief Valve O-Ring		<b>M96-2118</b>	<b>M96-1018</b>

#### Chemicals

Ultra PAG Oil 46 - 6pk, 8 oz Bottle	<b>MT3012</b>
Ultra PAG Oil 46 - 6pk, Quart Bottle	<b>MT3018</b>
Ultra PAG Oil 46 - Drum (52 gal)	<b>A10-6163</b>

#### Fasteners

Bolt - Shipping Plate / Shaft	<b>F20-2110</b>
Helical Insert - Rear Head / Shipping Plate (8-1.25 x 12mm)	<b>F10-6211</b>
Retaining Ring - Coil	<b>F10-4130</b>
Retaining Ring - Lip Seal	<b>F25-4111</b>
Washer - Head Bolt	<b>F20-3000</b>

#### Gaskets

O-Ring Kit	Green HNBR <b>K20-2177</b>
------------	----------------------------



Includes: Case O-Ring (1), Discharge Manifold O-Ring (1), High Pressure Relief Valve O-Ring (1)

#### Service Items

High Pressure Relief Valve (SCSA06)	<b>A20-5203</b>
-------------------------------------	-----------------

#### Shaft Seals

Lip Seal (Black Rubber Coated)	HNBR <b>S30-1110</b>
--------------------------------	----------------------

Lip Seal Kit	Green HNBR <b>K13-3129</b>
--------------	----------------------------



Includes: Lip Seal Retaining Ring (1), Lip Seal (1)

#### Shipping Closures

Shipping Plate (Use with C95-3003 & C95-3005)	<b>C95-4002</b>
---	-----------------

Shipping Plug (Discharge) (Use with C95-4002)	<b>C95-3003</b>
---	-----------------

Shipping Plug (Suction) (Use with C95-4002)	<b>C95-3005</b>
---	-----------------

#### Tools

Helical Insert Drill for 8-1.25mm Inserts	<b>T10-6053</b>
Helical Insert Tap 8-1.25mm	<b>T10-6254</b>
Helical Insert Tool 8-1.25mm - Bolt Style	<b>T10-6554</b>
Shaft Seal Protector, Adjustable	<b>T95-1229</b>
Helical Insert Repair Kit (8-1.25mm)	<b>K10-1180</b>



Includes: Helical Inserts (25), Drill (1), Tap (1), Installation Tool - Bolt Style (1)

## DENSO

### TV10CA, TV10CB

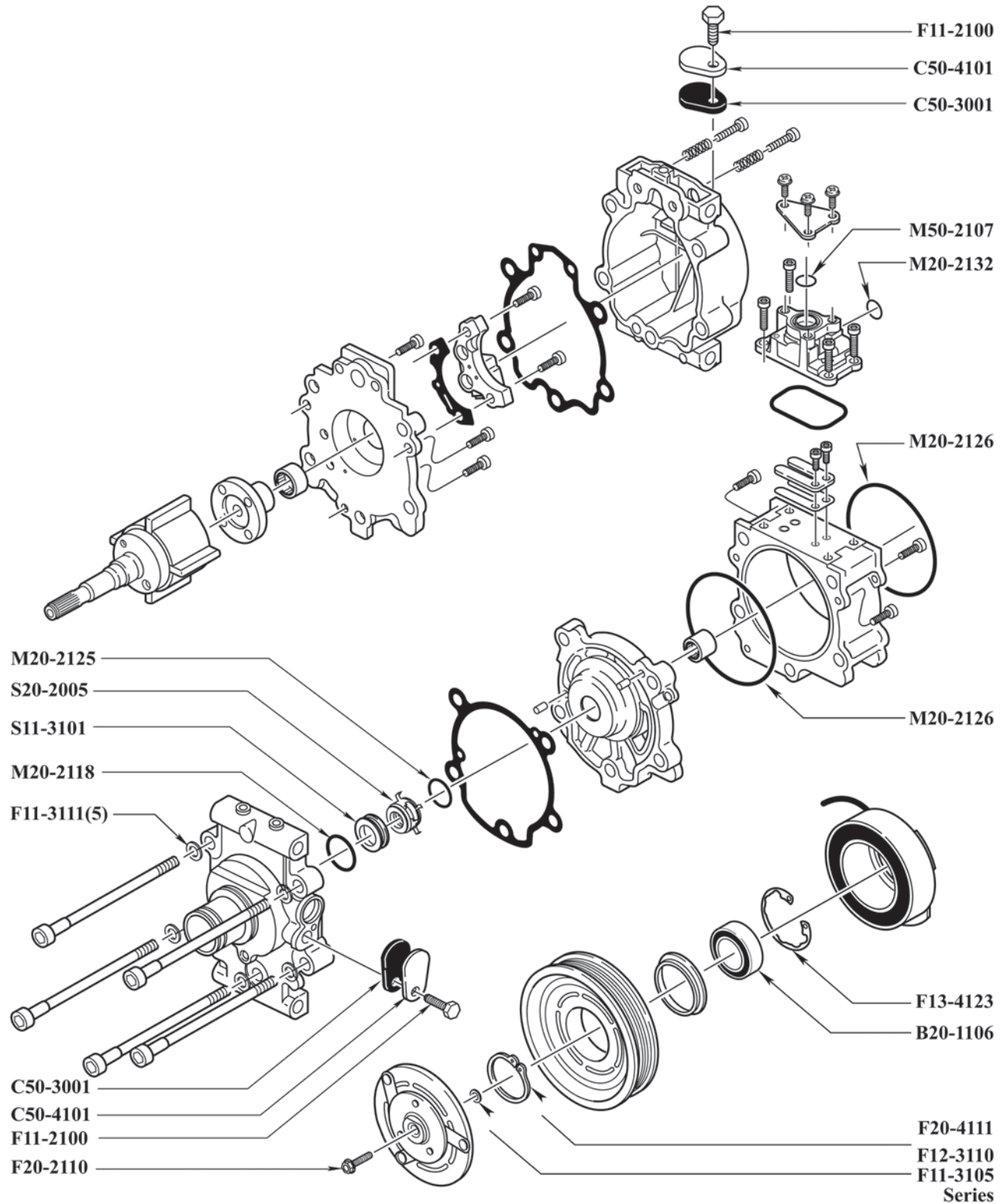

## DENSO

### TV10CA, TV10CB

O-Rings	R134a and R-12 Compatible	Green HNBR	Black Nitrile
Carbon Shaft Seal O-Ring		<b>M20-2125</b>	
Case O-Ring		<b>M20-2126</b>	
Shaft Seal Seat O-Ring		<b>M20-2118</b>	<b>M20-1018</b>
Temperature Switch Block O-Ring		<b>M20-2132</b>	<b>M20-1032</b>
Temperature Switch Dust Shield O-Ring		<b>M20-2131</b>	
Temperature Switch Dust Shield O-Ring		<b>M50-2107</b>	
Bearings		Shaft Seals	
Clutch Bearing (30mm x 52mm x 22mm)	<b>B20-1106</b>	Carbon Shaft Seal	Nitrile <b>S20-2005</b>
Chemicals		Metal Shaft Seal Seat	<b>S11-3101</b>
Ultra PAG Oil 100 - 6pk, 8 oz Bottle	<b>MT3013</b>	Shipping Closures	
Ultra PAG Oil 100 - 6pk, Quart Bottle	<b>MT3019</b>	Shipping Cap - Nose Protector	<b>C20-1000</b>
Ultra PAG Oil 100 - Drum (52 gal)	<b>A10-6164</b>	Shipping Pad (Use with C50-4101)	<b>C50-3001</b>
Fasteners		Shipping Plate (Use with C50-3001)	<b>C50-4101</b>
Bolt - Shaft	<b>F20-2110</b>	Shipping Plate (Use with C95-3004 & C95-3006)	<b>C95-4001</b>
Bolt - Shipping Plate	<b>F11-2100</b>	Shipping Plug (Discharge) (Use with C95-4001)	<b>C95-3004</b>
Helical Insert - Rear Head / Shipping Plate (8-1.25 x 12mm)	<b>F10-6211</b>	Shipping Plug (Suction) (Use with C95-4001)	<b>C95-3006</b>
Retaining Ring - Clutch Coil	<b>F13-4123</b>	Tools	
Retaining Ring - Pulley	<b>F12-4110</b>	Helical Insert Drill for 8-1.25mm Inserts	<b>T10-6053</b>
Retaining Ring - Pulley	<b>F20-4111</b>	Helical Insert Tap 8-1.25mm	<b>T10-6254</b>
Shim - Clutch (0.20mm)	<b>F11-3105</b>	Helical Insert Tool 8-1.25mm - Bolt Style	<b>T10-6554</b>
Shim - Clutch (0.20mm)	<b>F11-3115</b>	Shaft Seal Protector	<b>T25-1037</b>
Shim - Clutch (0.38mm)	<b>F12-3110</b>	Shaft Seal Protector, Adjustable	<b>T95-1228</b>
Washer - Head Bolt	<b>F11-3111</b>	Helical Insert Repair Kit (8-1.25mm)	<b>K10-1180</b>
Clutch Installation Kit	<b>K20-5107</b>		



Includes: Coil Retaining Ring (1), Pulley Retaining Ring (1), Shaft Bolt (1), Shim (0.20mm) (1), Shim (0.38mm) (1), Shim (0.51mm) (1).



Includes: Helical Inserts (25), Drill (1), Tap (1), Installation Tool - Bolt Style (1)

### Gaskets

#### O-Ring Kit Green HNBR **K20-2151**

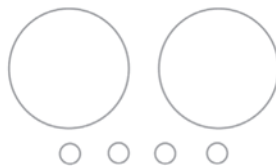

Includes: Metal Shaft Seal Seat O-Ring (1), Carbon Shaft Seal O-Ring (1), Case O-Ring (2), Sensor Block O-Ring (Small) (1), Sensor Block O-Ring (Large) (1)

## DENSO

### TV12C(R12), TV14C

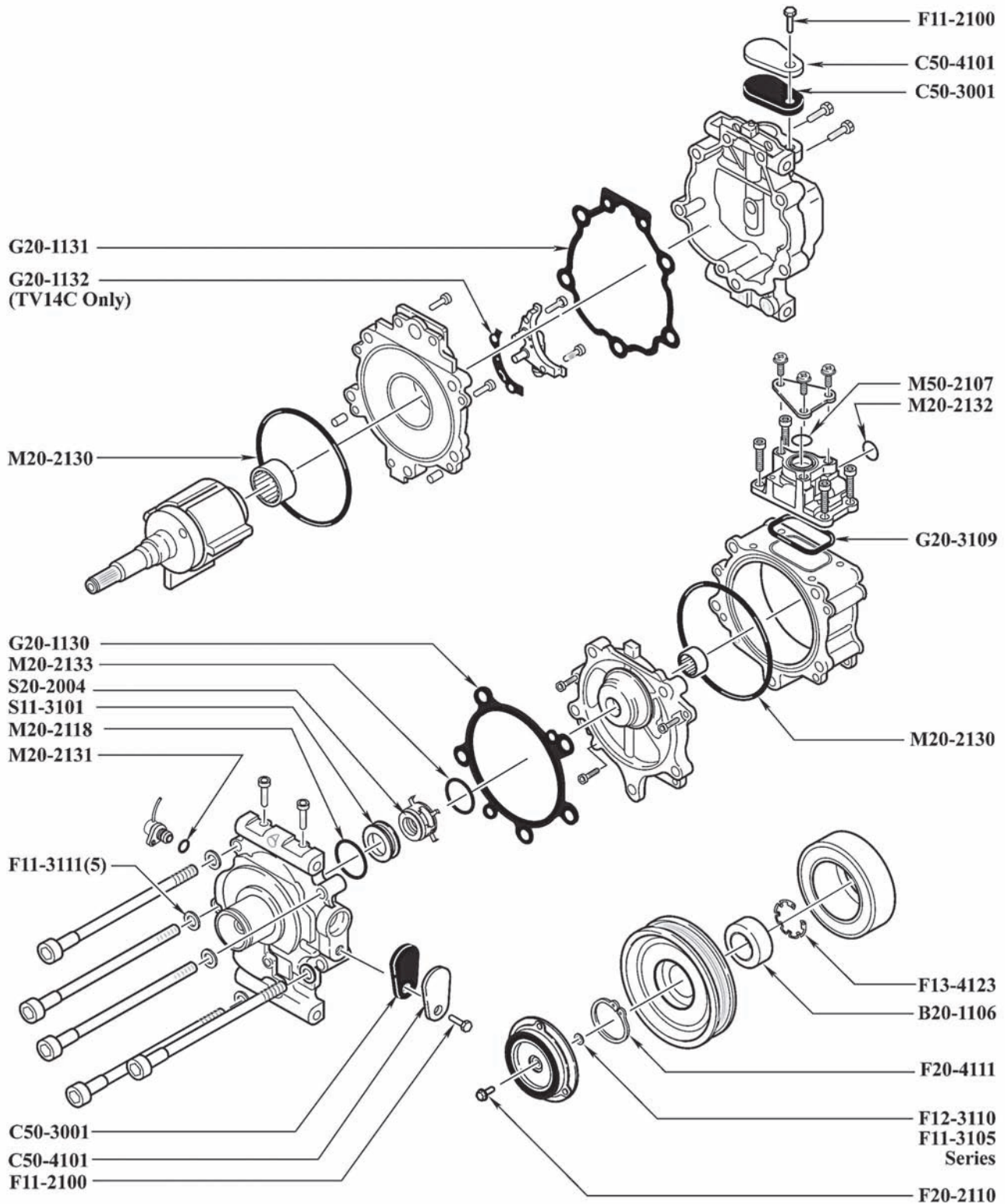

## DENSO

### TV12C(R12), TV14C

O-Rings	R134a and R-12 Compatible	Green HNBR	Black Nitrile
Adapter O-Ring		<b>M20-2115</b>	<b>M20-1015</b>
Carbon Shaft Seal O-Ring		<b>M20-2133</b>	
Case O-Ring		<b>M20-2130</b>	
Sensor O-Ring		<b>M20-2131</b>	
Shaft Seal Seat O-Ring		<b>M20-2118</b>	<b>M20-1018</b>
Temperature Switch Block O-Ring		<b>M20-2132</b>	<b>M20-1032</b>
Temperature Switch Dust Shield O-Ring		<b>M50-2107</b>	

#### Bearings

Clutch Bearing (30mm x 52mm x 22mm) **B20-1106**

#### Chemicals

Ultra PAG Oil 100 - 6pk, 8 oz Bottle **MT3013**

Ultra PAG Oil 100 - 6pk, Quart Bottle **MT3019**

Ultra PAG Oil 100 - Drum (52 gal) **A10-6164**

#### Fasteners

Bolt - Shaft **F20-2110**

Bolt - Shipping Plate **F11-2100**

Helical Insert - Rear Head / Shipping Plate (8-1.25 x 12mm) **F10-6211**

Retaining Ring - Clutch Coil **F13-4123**

Retaining Ring - Pulley **F12-4110**

Retaining Ring - Pulley **F20-4111**

Shim - Clutch (0.20mm) **F11-3105**

Shim - Clutch (0.20mm) **F11-3115**

Shim - Clutch (0.38mm) **F12-3110**

Washer - Head Bolt **F11-3111**

Clutch Installation Kit **K20-5107**



*Includes: Coil Retaining Ring (1), Pulley Retaining Ring (1), Shaft Bolt (1), Shim (0.20mm) (1), Shim (0.38mm) (1), Shim (0.51mm) (1).*

#### Gaskets

Gasket - Front Head Fiber **G20-1130**

Gasket - Rear Head Fiber **G20-1131**

Gasket - Rotor Pressure Bypass (TV14C Only) Fiber **G20-1132**

Gasket - High Temperature Sensor Manifold Green HNBR **G20-3109**

#### Gaskets

Gasket Kit (Fiber) Green HNBR **K20-2150**

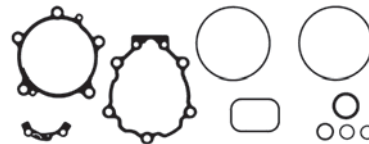

*Includes: Gaskets: Front Head(1), Rear Head(1), Rotor Pressure Bypass(TV14C)(1), Hi Temp Sensor Manifold(1); O-Rings: Metal Seat(1), Case(2), Sensor(1), Hi Temp Block(1), Carbon Shaft Seal(1).*

#### Shaft Seals

Carbon Ring Nitrile **S20-2003**

Carbon Shaft Seal Nitrile **S20-2004**

Metal Shaft Seal Seat **S11-3101**

Carbon Ring Kit Green HNBR **K20-3156**



*Includes: Carbon Ring (1), Carbon Shaft Seal O-Ring (1).*

#### Shipping Closures

Shipping Cap - Nose Protector **C20-1000**

Shipping Pad (Use with C50-4101) **C50-3001**

Shipping Plate (Use with C50-3001) **C50-4101**

Shipping Plate (Use with C95-3004 & C95-3006) **C95-4001**

Shipping Plug (Discharge) (Use with C95-4001) **C95-3004**

Shipping Plug (Suction) (Use with C95-4001) **C95-3006**

#### Tools

Helical Insert Drill for 8-1.25mm Inserts **T10-6053**

Helical Insert Tap 8-1.25mm **T10-6254**

Helical Insert Tool 8-1.25mm - Bolt Style **T10-6554**

Shaft Seal Protector **T45-1002**

Shaft Seal Protector, Adjustable **T95-1227**

## DENSO

### TV12C(R134)

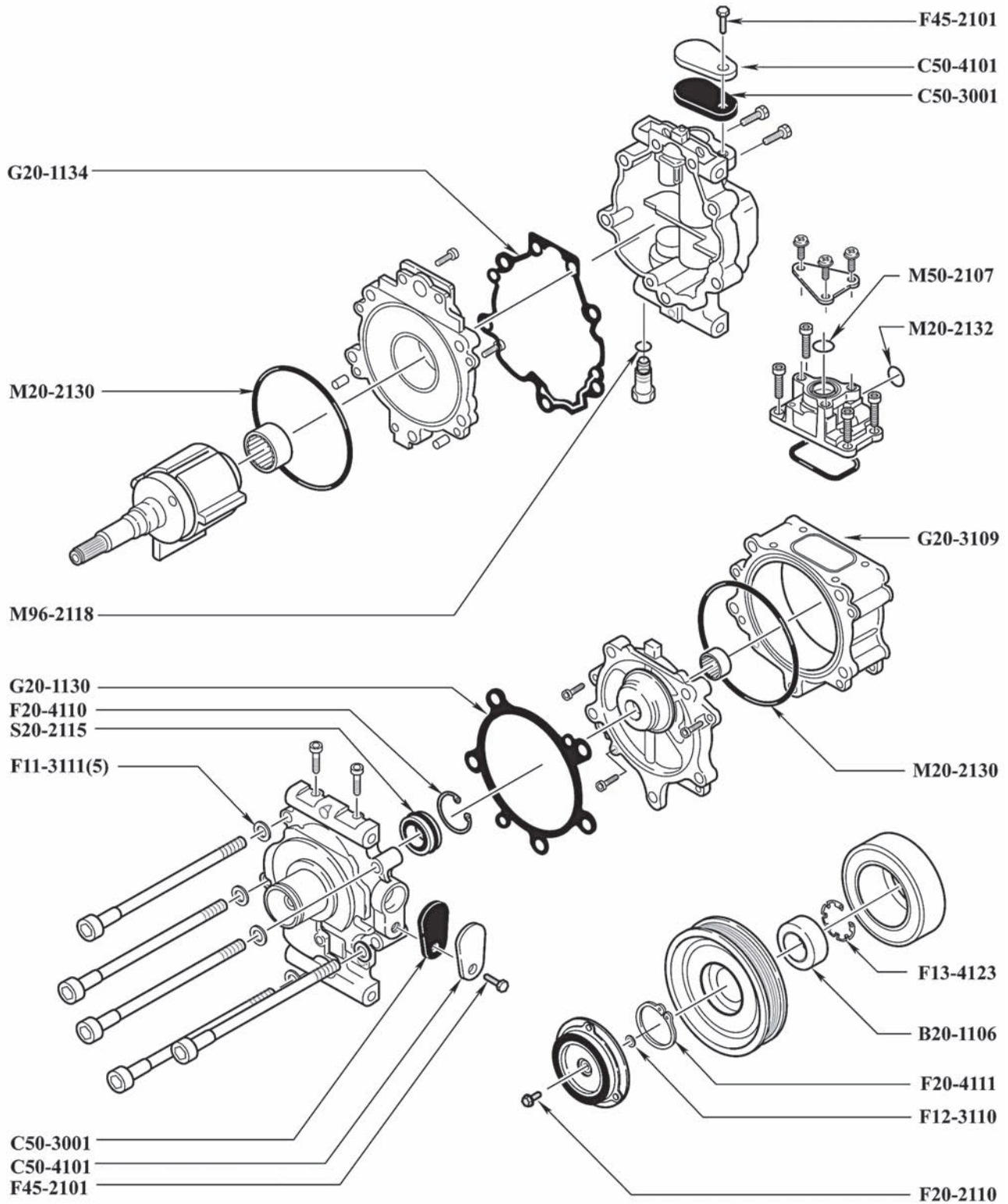

## DENSO

### TV12C(R134)

O-Rings	R134a and R-12 Compatible	Green HNBR	Black Nitrile
Adapter O-Ring		<b>M20-2115</b>	<b>M20-1015</b>
Case O-Ring		<b>M20-2130</b>	
High Pressure Relief Valve O-Ring		<b>M96-2118</b>	<b>M96-1018</b>
Temperature Switch Block O-Ring		<b>M20-2132</b>	<b>M20-1032</b>
Temperature Switch Dust Shield O-Ring		<b>M50-2107</b>	

Bearings	
Clutch Bearing (30mm x 52mm x 22mm)	<b>B20-1106</b>

Chemicals	
Ultra PAG Oil 100 - 6pk, 8 oz Bottle	<b>MT3013</b>
Ultra PAG Oil 100 - 6pk, Quart Bottle	<b>MT3019</b>
Ultra PAG Oil 100 - Drum (52 gal)	<b>A10-6164</b>

Electrical	
Pigtail - Denso 5SE / TV12C Control Valve Connector	<b>E95-4020</b>

Fasteners	
Bolt - Shaft	<b>F20-2110</b>
Bolt - Shipping Plate	<b>F45-2101</b>
Retaining Ring - Clutch Coil	<b>F13-4123</b>
Retaining Ring - Pulley	<b>F12-4110</b>
Retaining Ring - Pulley	<b>F20-4111</b>
Retaining Ring - Shaft Seal Seat	<b>F20-4110</b>
Shim - Clutch (0.38mm)	<b>F12-3110</b>
Washer - Head Bolt	<b>F11-3111</b>
Clutch Installation Kit	<b>K20-5107</b>



Includes: Coil Retaining Ring (1), Pulley Retaining Ring (1), Shaft Bolt (1), Shim (0.20mm) (1), Shim (0.38mm) (1), Shim (0.51mm) (1).

Gaskets	
Gasket - Front Head	Fiber <b>G20-1130</b>
Gasket - Rear Head	Fiber <b>G20-1134</b>
Gasket - High Temperature Sensor Manifold	Green HNBR <b>G20-3109</b>

Gaskets	
Gasket Kit (Fiber)	Green HNBR <b>K20-2152</b>

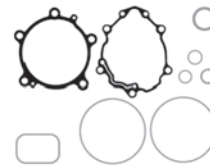

Includes: Gaskets: Front Head(1), Rear Head(1), Hi Temp Sensor Manifold(1); O-Rings: R134a Adapter (1), Case(2), Hi Temp Block(1), Pressure Relief Valve(1), Temperature Switch Dust Shield(1).

Shaft Seals	
Lip Seal	HNBR <b>S20-2115</b>
Lip Seal Kit	Green HNBR <b>K20-3155</b>



Includes: Retaining Ring (1), Lip Seal (1)

Shipping Closures	
Shipping Cap - Nose Protector	<b>C20-1000</b>
Shipping Pad (Use with C50-4101)	<b>C50-3001</b>
Shipping Plate (Use with C50-3001)	<b>C50-4101</b>
Shipping Plate (Use with C95-3004 & C95-3006)	<b>C95-4002</b>
Shipping Plug (Discharge) (Use with C95-4002)	<b>C95-3004</b>
Shipping Plug (Suction) (Use with C95-4002)	<b>C95-3006</b>

Tools	
Shaft Seal Protector	<b>T45-1002</b>
Shaft Seal Protector, Adjustable	<b>T95-1227</b>

## DENSO

### TV12EC(R12), TV14EC

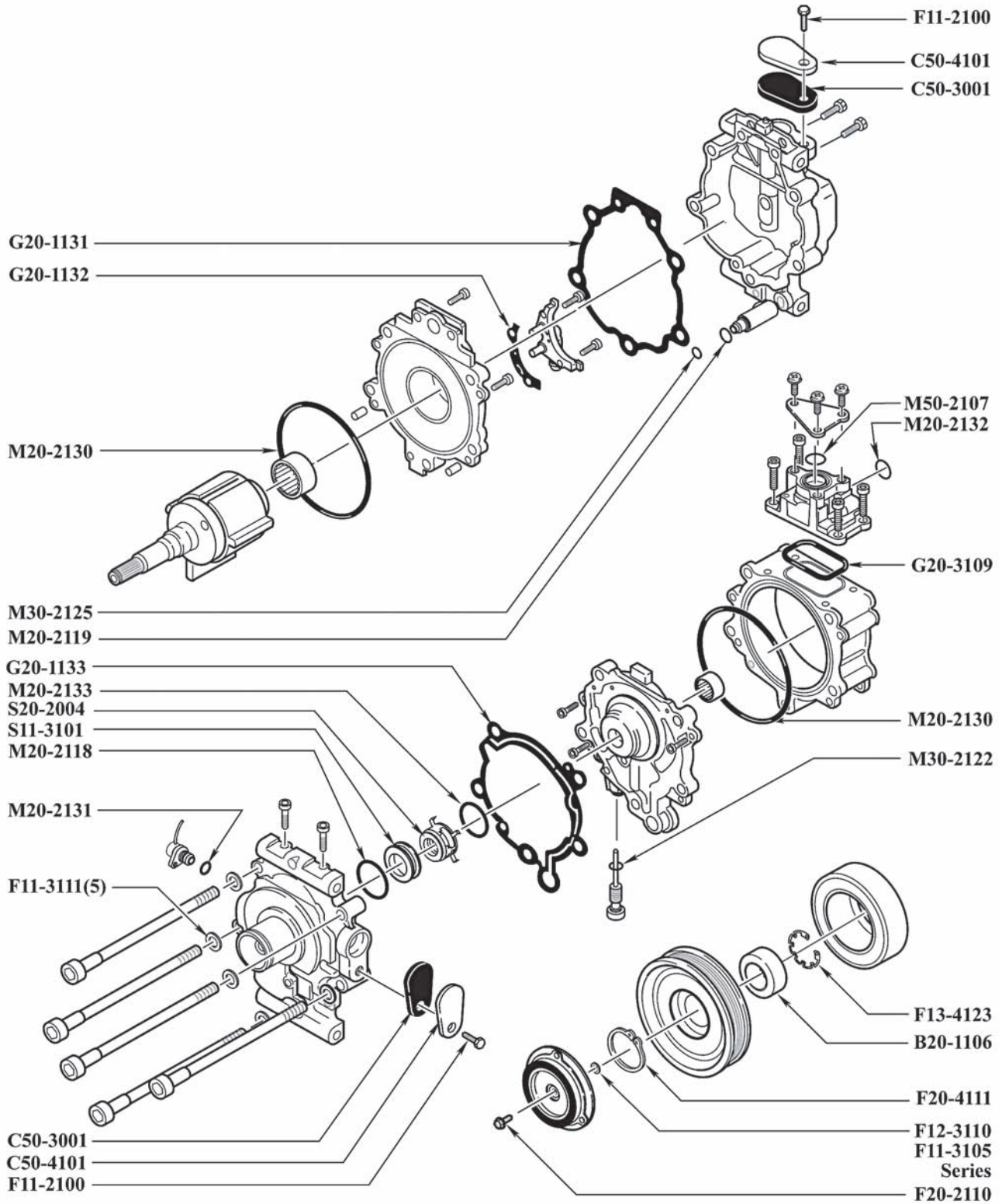



## DENSO

### TV12EC(R12), TV14EC

O-Rings	R134a and R-12 Compatible	Green HNBR	Black Nitrile
Carbon Shaft Seal O-Ring		<b>M20-2133</b>	
Case O-Ring		<b>M20-2130</b>	
Control Valve O-Ring (Large)		<b>M20-2119</b>	
Control Valve O-Ring (Small)		<b>M30-2125</b>	
Needle Valve O-Ring		<b>M30-2122</b>	
Sensor O-Ring		<b>M20-2131</b>	
Shaft Seal Seat O-Ring		<b>M20-2118</b>	<b>M20-1018</b>
Temperature Switch Block O-Ring		<b>M20-2132</b>	<b>M20-1032</b>
Temperature Switch Dust Shield O-Ring		<b>M50-2107</b>	

#### Bearings

Clutch Bearing (30mm x 52mm x 22mm) **B20-1106**

#### Chemicals

Ultra PAG Oil 100 - 6pk, 8 oz Bottle **MT3013**

Ultra PAG Oil 100 - 6pk, Quart Bottle **MT3019**

Ultra PAG Oil 100 - Drum (52 gal) **A10-6164**

#### Fasteners

Bolt - Shaft **F20-2110**

Bolt - Shipping Plate **F11-2100**

Helical Insert - Rear Head / Shipping Plate (8-1.25 x 12mm) **F10-6211**

Retaining Ring - Clutch Coil **F13-4123**

Retaining Ring - Pulley **F12-4110**

Retaining Ring - Pulley **F20-4111**

Shim - Clutch (0.20mm) **F11-3105**

Shim - Clutch (0.20mm) **F11-3115**

Shim - Clutch (0.38mm) **F12-3110**

Washer - Head Bolt **F11-3111**

Clutch Installation Kit **K20-5107**



*Includes: Coil Retaining Ring (1), Pulley Retaining Ring (1), Shaft Bolt (1), Shim (0.20mm) (1), Shim (0.38mm) (1), Shim (0.51mm) (1).*

#### Gaskets

Gasket - Front Head Fiber **G20-1133**

Gasket - Rear Head Fiber **G20-1131**

Gasket - Rotor Pressure By-Pass Fiber **G20-1132**

Gasket - High Temperature Sensor Manifold Green HNBR **G20-3109**

#### Gaskets

Gasket Kit (Fiber) Green HNBR **K20-2153**

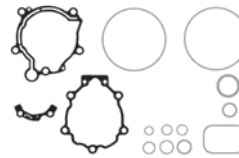

*Includes: Gaskets: Rear Head(1), Front Head(1), Rotor PSI By-Pass(1), Manifold(1); O-Rings: Shaft Seal Seat(1), Large Crossover(1), Case(2), Sensor(1), Temp Block(1), Carbon Shaft Seal(1), Oil Bleed Valve(1), Small Crossover(1), Temp Sw Dust Shield(1).*

#### Shaft Seals

Carbon Ring Nitrile **S20-2003**

Carbon Shaft Seal Nitrile **S20-2004**

Metal Shaft Seal Seat **S11-3101**

Carbon Ring Kit Green HNBR **K20-3156**



*Includes: Carbon Ring (1), Carbon Shaft Seal O-Ring (1).*

#### Shipping Closures

Shipping Cap - Nose Protector **C20-1000**

Shipping Pad (Use with C50-4101) **C50-3001**

Shipping Plate (Use with C50-3001) **C50-4101**

Shipping Plate (Use with C95-3004 & C95-3006) **C95-4001**

Shipping Plug (Discharge) (Use with C95-4001) **C95-3004**

Shipping Plug (Suction) (Use with C95-4001) **C95-3006**

#### Tools

Helical Insert Drill for 8-1.25mm Inserts **T10-6053**

Helical Insert Tap 8-1.25mm **T10-6254**

## DENSO

TV12EC(R12), TV14EC

### Tools

Helical Insert Tool 8-1.25mm - Bolt Style	<b>T10-6554</b>
Shaft Seal Protector	<b>T45-1002</b>
Shaft Seal Protector, Adjustable	<b>T95-1227</b>
Helical Insert Repair Kit (8-1.25mm)	<b>K10-1180</b>



*Includes: Helical Inserts (25), Drill (1), Tap (1), Installation Tool - Bolt Style (1)*



## DENSO

### TV12SC(R134), TV14SC

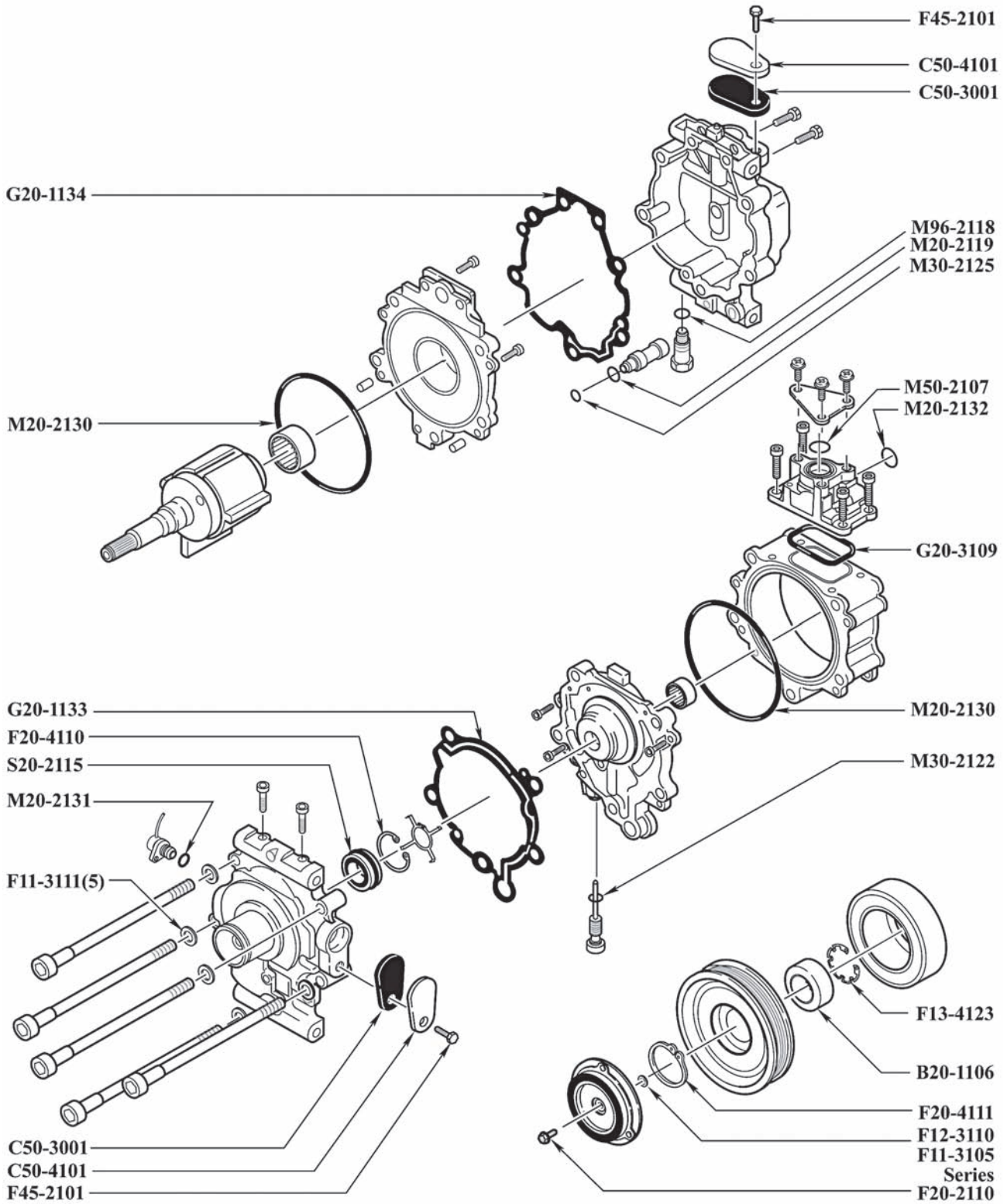

## DENSO

### TV12SC(R134), TV14SC

O-Rings	R134a and R-12 Compatible	Green HNBR	Black Nitrile
Adapter O-Ring		M20-2115	M20-1015
Case O-Ring		M20-2130	
Control Valve O-Ring (Large)		M20-2119	
Control Valve O-Ring (Small)		M30-2125	
High Pressure Relief Valve O-Ring		M96-2118	M96-1018
Needle Valve O-Ring		M30-2122	
Sensor O-Ring		M20-2131	
Temperature Switch Block O-Ring		M20-2132	M20-1032
Temperature Switch Dust Shield O-Ring		M50-2107	

#### Bearings

Clutch Bearing (30mm x 52mm x 22mm) **B20-1106**

#### Chemicals

Ultra PAG Oil 100 - 6pk, 8 oz Bottle **MT3013**

Ultra PAG Oil 100 - 6pk, Quart Bottle **MT3019**

Ultra PAG Oil 100 - Drum (52 gal) **A10-6164**

#### Fasteners

Bolt - Shaft **F20-2110**

Bolt - Shipping Plate **F45-2101**

Retaining Ring - Clutch Coil **F13-4123**

Retaining Ring - Lip Seal **F20-4110**

Retaining Ring - Pulley **F12-4110**

Retaining Ring - Pulley **F20-4111**

Shim - Clutch (0.20mm) **F11-3105**

Shim - Clutch (0.20mm) **F11-3115**

Shim - Clutch (0.38mm) **F12-3110**

Washer - Head Bolt **F11-3111**

Clutch Installation Kit **K20-5107**



*Includes: Coil Retaining Ring (1), Pulley Retaining Ring (1), Shaft Bolt (1), Shim (0.20mm) (1), Shim (0.38mm) (1), Shim (0.51mm) (1).*

#### Gaskets

Gasket - Front Head Fiber **G20-1133**

Gasket - Rear Head Fiber **G20-1134**

Gasket - High Temperature Green HNBR **G20-3109**

Sensor Manifold

#### Gaskets

Gasket Kit (Fiber) Green HNBR **K20-2154**

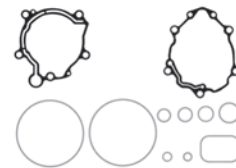

*Includes: Gaskets: Rear Head(1), Front Head(1), Manifold(1); O-Rings: Large Crossover(1), Case(2), Temp Block(1), Oil Bleed Valve(1), Temp Sw Dust Shield(1), R134a Adapter(1), Pressure Relief Valve(1).*

#### Shaft Seals

Lip Seal HNBR **S20-2115**

Lip Seal Kit Green HNBR **K20-3155**



*Includes: Retaining Ring (1), Lip Seal (1)*

#### Shipping Closures

Shipping Cap - Nose Protector **C20-1000**

Shipping Pad (Use with C50-4101) **C50-3001**

Shipping Plate (Use with C50-3001) **C50-4101**

Shipping Plate (Use with C95-3004) **C95-4002**

Shipping Plug (Suction/Disch) (Use with C95-4002) **C95-3004**

#### Tools

Shaft Seal Protector **T45-1002**

Shaft Seal Protector, Adjustable **T95-1227**

Shaft Seal Protector, Adjustable **T95-1228**

## DIESEL KIKI

DCV11A, DCV14A, DKV11A

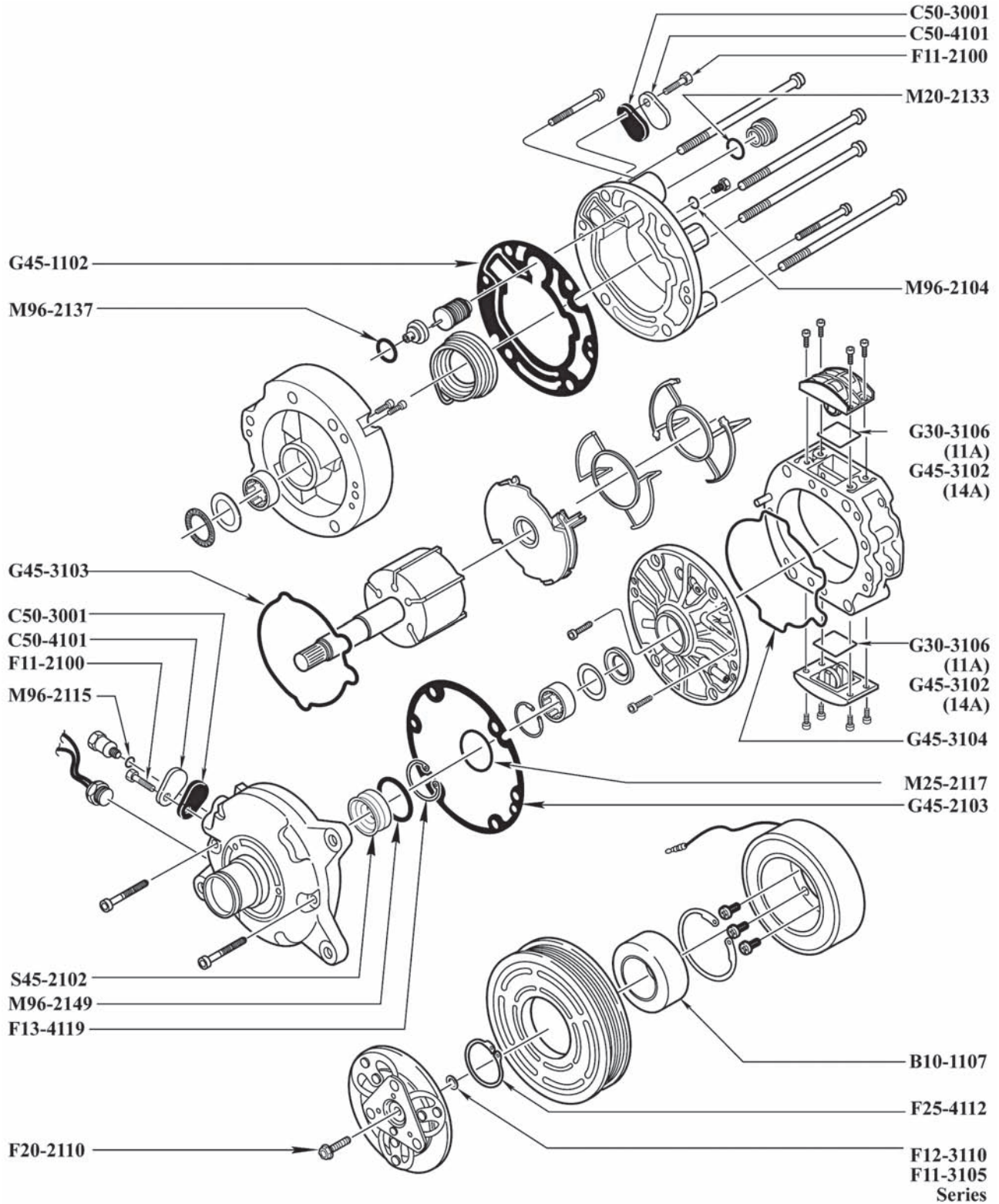

## DIESEL KIKI

DCV11A, DCV14A, DKV11A

O-Rings	R134a and R-12 Compatible	Green HNBR	Black Nitrile
Internal Bellows Plunger O-Ring		<b>M96-2137</b>	<b>M96-1037</b>
Internal Front Rotor Housing to Nose O-Ring		<b>M25-2117</b>	<b>M25-1017</b>
Lip Seal O-Ring		<b>M96-2149</b>	
Oil Drain Plug O-Ring		<b>M96-2104</b>	
Pressure Relief Valve O-Ring		<b>M96-2115</b>	<b>M96-1015</b>
Rear Bellows Plunger O-Ring		<b>M20-2133</b>	

### Bearings

Clutch Bearing (35mm x 55mm x 20mm)	<b>B10-1107</b>
-------------------------------------	-----------------

### Chemicals

Ultra PAG Oil 100 - 6pk, 8 oz Bottle	<b>MT3013</b>
Ultra PAG Oil 100 - 6pk, Quart Bottle	<b>MT3019</b>
Ultra PAG Oil 100 - Drum (52 gal)	<b>A10-6164</b>

### Fasteners

Bolt - Shaft	<b>F20-2110</b>
Bolt - Shipping Plate	<b>F11-2100</b>
Helical Insert - Rear Head / Shipping Plate (8-1.25 x 12mm)	<b>F10-6211</b>
Retaining Ring - Clutch Pulley	<b>F25-4112</b>
Retaining Ring - Lip Seal	<b>F13-4119</b>
Shim - Clutch (0.20mm)	<b>F11-3105</b>
Shim - Clutch (0.38mm)	<b>F12-3110</b>
Shim - Clutch (0.51mm)	<b>F11-3115</b>

### Gaskets

Gasket - Front Head	Fiber <b>G45-1103</b>
Gasket - Rear Head (Early)	Fiber <b>G45-1102</b>
Gasket - Front Head	Metal <b>G45-2103</b>
Gasket - Rear Head (Late)	Metal <b>G45-2104</b>
Gasket - Front Molded	Green HNBR <b>G45-3104</b>
Gasket - Rear Molded	Green HNBR <b>G45-3103</b>
Gasket - Reed Plate (DCV11A/DKV11A)	Green HNBR <b>G30-3106</b>
Gasket - Reed Plate (DCV14A)	Green HNBR <b>G45-3102</b>
Gasket Kit (Fiber) (Early DCV11A/DKV11A)	Green HNBR <b>K30-2122</b>

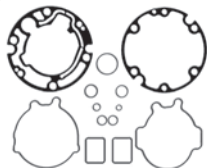

*Includes: Gaskets: Rear Head(1), Front Head(1), Reed Plate Molded(2), Rear Molded (1), Front Molded(1); O-Rings: Rear Bellows Plunger(1), Bellows Plunger(1), Internal Front Rotor Housing to Nose(1), Pressure Relief Valve(1), Oil Bleed(1).*

### Gaskets

Gasket Kit (Fiber) (Early DCV14A)	Green HNBR <b>K45-2106</b>
-----------------------------------	----------------------------

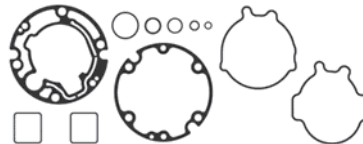

*Includes: Gaskets: Rear Head(1), Front Head(1), Reed Plate Molded(2), Rear Molded (1), Front Molded(1); O-Rings: Rear Bellows Plunger(1), Bellows Plunger(1), Internal Front Rotor Housing to Nose(1), Pressure Relief Valve(1), Oil Bleed(1).*

Gasket Kit (Metal) (Late DCV14A)	Green HNBR <b>K45-2108</b>
----------------------------------	----------------------------

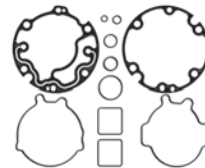

*Includes: Gaskets: Rear Head(1), Front Head(1), Reed Plate Molded(2), Rear Molded (1), Front Molded(1); O-Rings: Rear Bellows Plunger(1), Bellows Plunger(1), Internal Front Rotor Housing to Nose(1), Pressure Relief Valve(1), Oil Bleed(1).*

### Shaft Seals

Lip Seal	HNBR <b>S45-2102</b>
Lip Seal Kit	Green HNBR <b>K45-3107</b>



*Includes: Lip Seal Retaining Ring (1), Lip Seal (1)*

### Shipping Closures

Shipping Pad (Use with C50-4101)	<b>C50-3001</b>
Shipping Plate (Use with C50-3001)	<b>C50-4101</b>
Shipping Plate (Use with C95-3002/3003/3004)	<b>C95-4001</b>
Shipping Plug (Discharge) (Use with C95-4001) (DCV11A/14A)	<b>C95-3003</b>

## DIESEL KIKI

DCV11A, DCV14A, DKV11A

### Shipping Closures

Shipping Plug (Discharge) (Use with C95-4001) (DKV11A) **C95-3002**

Shipping Plug (Suction) (Use with C95-4001) **C95-3004**

### Tools

Helical Insert Drill for 8-1.25mm Inserts **T10-6053**

Helical Insert Tap 8-1.25mm **T10-6254**

Helical Insert Tool 8-1.25mm - Bolt Style **T10-6554**

Shaft Seal Protector **T11-1000**

Shaft Seal Protector, Adjustable **T95-1228**

Helical Insert Repair Kit (8-1.25mm) **K10-1180**



*Includes: Helical Inserts (25), Drill (1), Tap (1), Installation Tool - Bolt Style (1)*



## DIESEL KIKI

DCV11D, DKV11D

O-Rings	R134a and R-12 Compatible	Green HNBR	Black Nitrile
Internal Front Rotor Housing to Nose O-Ring		M25-2117	M25-1017
<b>Chemicals</b>			
Ultra PAG Oil 150 - 6pk, 8 oz Bottle	MT3014		
Ultra PAG Oil 150 - 6pk, Quart Bottle	MT3020		
Ultra PAG Oil 150 - Drum (52 gal)	A10-6165		
<b>Gaskets</b>			
Gasket - Front Head	Fiber G45-1103		
Gasket - Rear Head	Fiber G75-1000		
Gasket - Front Head	Metal G45-2103		
Gasket - Front Molded	Green HNBR G45-3104		
Gasket - Rear Molded	Green HNBR G45-3103		
Gasket - Reed Plate	Green HNBR G30-3106		
Gasket Kit (Fiber)	Green HNBR K30-2129		

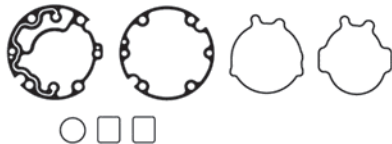

Includes: Reed Plate Molded Gasket (2), Front Head Gasket (1), Rear Molded Gasket (1), Front Molded Gasket (1), Rear Head Gasket (1), Front Nose to Case O-Ring (1).

<b>Shaft Seals</b>	
Lip Seal	HNBR S45-2102
<b>Shipping Closures</b>	
Shipping Plate (Use with C95-3003 & C95-3004)	C95-4001
Shipping Plug (Discharge) (Use with C95-4001)	C95-3003
Shipping Plug (Suction) (Use with C95-4001)	C95-3004

## DIESEL KIKI DCV14J, DKV14J

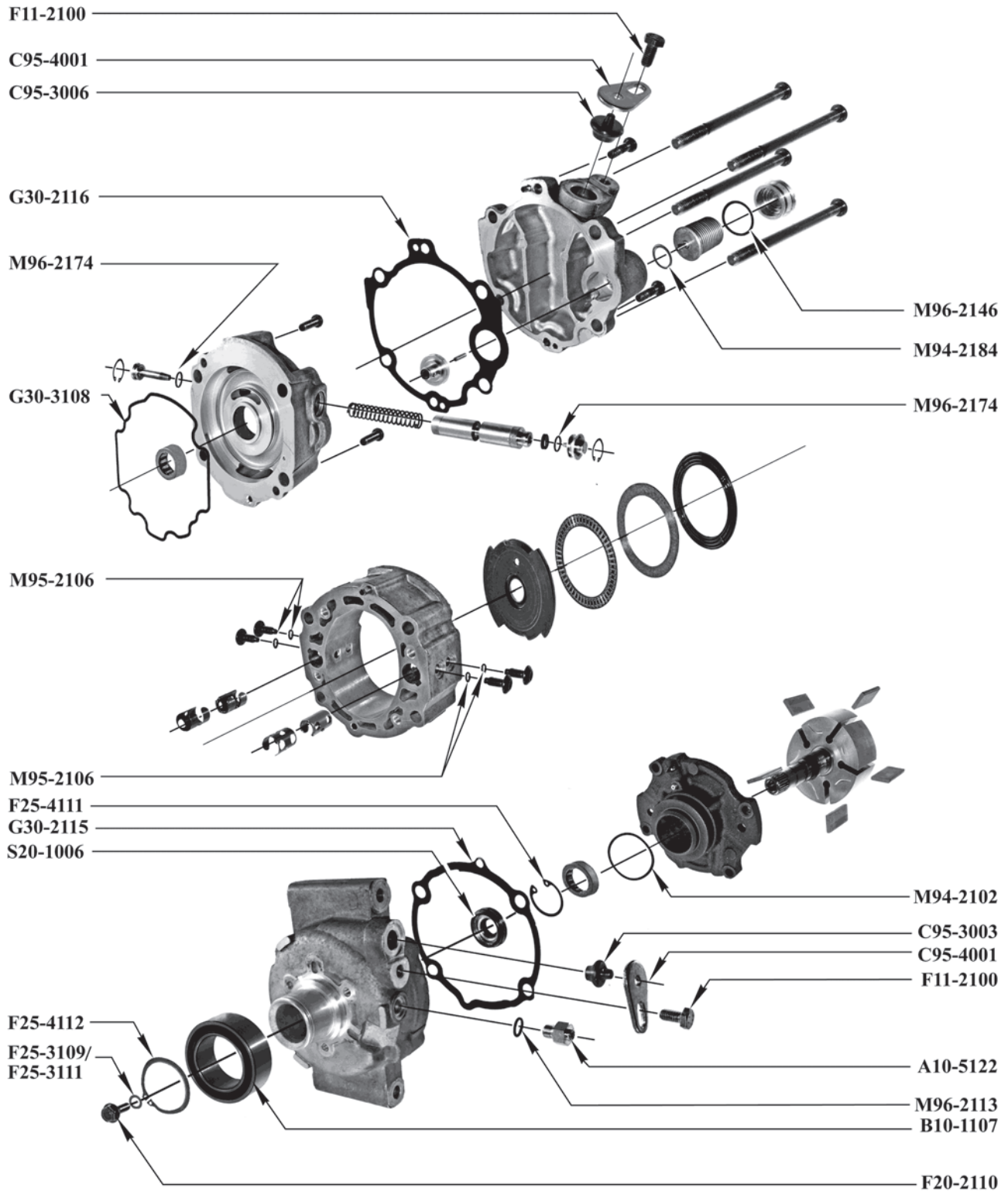

## DIESEL KIKI

### DCV14J, DKV14J

O-Rings	R134a and R-12 Compatible	Green HNBR	Black Nitrile
Bellows Adjustment Screw O-Ring		<b>M96-2146</b>	<b>M96-1046</b>
Bellows O-Ring		<b>M94-2184</b>	
Control Valve O-Ring		<b>M96-2174</b>	
Discharge Reed Bolt O-Ring		<b>M95-2106</b>	<b>M95-1006</b>
Discharge Reed Housing Bolt O-Ring		<b>M95-2106</b>	<b>M95-1006</b>
Internal Front Housing to Nose O-Ring		<b>M94-2102</b>	<b>M94-1002</b>
Pressure Relief Valve O-Ring		<b>M96-2113</b>	

#### Bearings

Clutch Bearing (35mm x 55mm x 20mm) **B10-1107**

#### Chemicals

Ultra PAG Oil 100 - 6pk, 8 oz Bottle **MT3013**

Ultra PAG Oil 100 - 6pk, Quart Bottle **MT3019**

Ultra PAG Oil 100 - Drum (52 gal) **A10-6164**

#### Fasteners

Bolt - Shaft **F20-2110**

Bolt - Shipping Plate **F11-2100**

Helical Insert - Rear Head / Shipping Plate (8-1.25 x 12mm) **F10-6211**

Front Case Bearing Retaining Ring **F25-4111**

Retaining Ring - Clutch Pulley **F25-4112**

Shim - Clutch (0.38mm) **F25-3111**

Shim - Clutch (0.76mm) **F25-3109**

#### Gaskets

Gasket - Metal - Front Metal **G30-2115**

Gasket - Metal - Rear Metal **G30-2115**

Gasket - Metal - Rear Metal **G30-2116**

Gasket - Rotor Body Green HNBR **G30-3108**

Gasket Kit (Metal) **K30-5003**

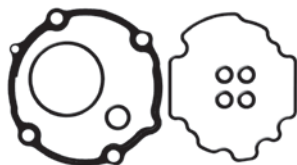

*Includes: Front Head Gasket (1), Rotor Rear Gasket (1), Discharge Reed Bolt O-Ring (4), PRV O-Ring (1), Rotor Nose O-Ring*

#### Service Items

High Pressure Relief Valve 3/8-24 w/Non-Captive O-Ring **A10-5122**

#### Shaft Seals

Lip Seal (Black Rubber Coated) HNBR **S20-1006**

#### Shipping Closures

Shipping Plate (Use with C95-3002/3003/3005/3006) **C95-4001**

Shipping Plug (Discharge - DCV) (Use with C95-4001) **C95-3003**

Shipping Plug (Discharge - DKV) (Use with C95-4001) **C95-3002**

Shipping Plug (Suction - DCV) (Use with C95-4001) **C95-3006**

Shipping Plug (Suction - DKV) (Use with C95-4001) **C95-3005**

#### Tools

Helical Insert Drill for 8-1.25mm Inserts **T10-6053**

Helical Insert Tap 8-1.25mm **T10-6254**

Helical Insert Tool 8-1.25mm - Bolt Style **T10-6554**

Helical Insert Repair Kit (8-1.25mm) **K10-1180**



*Includes: Helical Inserts (25), Drill (1), Tap (1), Installation Tool - Bolt Style (1)*

## DIESEL KIKI DCW17B, DCW17D

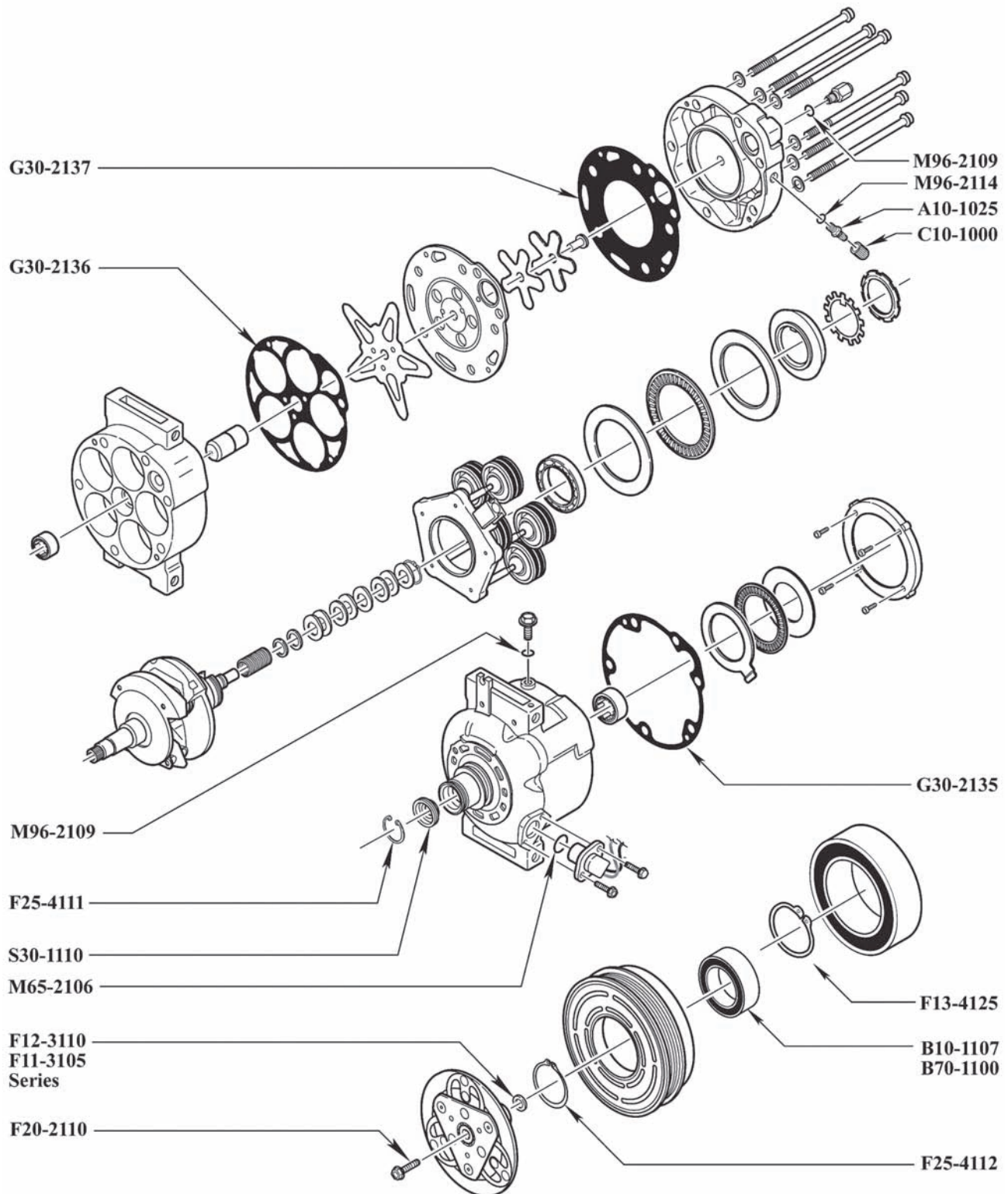

## DIESEL KIKI

DCW17B, DCW17D

O-Rings	R134a and R-12 Compatible	Green HNBR	Black Nitrile
Control Valve O-Ring		<b>M11-2106</b>	<b>M11-1006</b>
Pressure Relief Valve/Oil Drain Plug O-Ring		<b>M96-2109</b>	<b>M96-1009</b>
Service Valve O-Ring		<b>M96-2114</b>	
Speed Sensor O-Ring		<b>M65-2106</b>	<b>M65-1006</b>

Bearings	
Clutch Bearing (35mm x 55mm x 20mm)	<b>B10-1107</b>
Clutch Bearing (35mm x 62mm x 24mm)	<b>B70-1100</b>

Chemicals	
Ultra PAG Oil 46 - 6pk, 8 oz Bottle	<b>MT3012</b>
Ultra PAG Oil 46 - 6pk, Quart Bottle	<b>MT3018</b>
Ultra PAG Oil 46 - Drum (52 gal)	<b>A10-6163</b>

Fasteners	
Bolt - Shaft	<b>F20-2110</b>
Retaining Ring - Clutch Coil (Beveled)	<b>F13-4125</b>
Retaining Ring - Lip Seal	<b>F25-4111</b>
Retaining Ring - Pulley	<b>F25-4112</b>
Retaining Ring - Pulley (Beveled)	<b>F13-4125</b>
Retaining Ring (Beveled) - Lip Seal	<b>F25-4110</b>
Shim - Clutch (0.20mm)	<b>F11-3105</b>
Shim - Clutch (0.38mm)	<b>F12-3110</b>
Shim - Clutch (0.51mm)	<b>F11-3115</b>

Gaskets	
Gasket - Cylinder	Metal <b>G30-2136</b>
Gasket - Front Head	Metal <b>G30-2135</b>
Gasket - Rear Head	Metal <b>G30-2137</b>
Gasket Kit (Metal) (DCW17B/DCW17D)	Green HNBR <b>K30-2131</b>

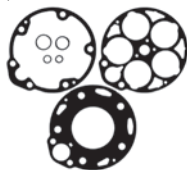

Includes: Gaskets: Front Head Gasket(1), Rear Head Gasket(1), Cylinder Gasket(1).

Service Items	
Fitting (Refrigerant) - 1/8-28 UNF w/Valve/O-Ring	<b>A10-1025</b>

Shaft Seals	
Lip Seal (Black Rubber Coated)	HNBR <b>S30-1110</b>

Shaft Seals	
Lip Seal Kit	Green HNBR <b>K30-1110</b>



Includes: Lip Seal Retaining Ring (1), Lip Seal Metal Spacer (1), Lip Seal (1)

Shipping Closures	
Cap - 1/4" Low Side	<b>C10-1000</b>
Shipping Cap - Discharge Port (Vinyl) (R134a)	<b>C30-1101</b>
Shipping Cap - Suction Port (R134a) (Use with C30-1103)	<b>C30-1102</b>
Shipping Cap - Suction Port (Vinyl) (R134a)	<b>C30-1103</b>
Shipping Plug (Discharge Port) (R134a)	<b>C11-2100</b>

Tools	
Shaft Seal Protector, Adjustable	<b>T95-1228</b>

## **DIESEL KIKI**

**DKS13CH**

## DIESEL KIKI

### DKS13CH

O-Rings	R134a and R-12 Compatible	Green HNBR	Black Nitrile
Lip Seal O-Ring		M30-2100	M30-1000
<b>Bearings</b>			
Clutch Bearing (35mm x 55mm x 20mm)	B10-1107		
<b>Chemicals</b>			
Ultra PAG Oil 46 - 6pk, 8 oz Bottle	MT3012		
Ultra PAG Oil 46 - 6pk, Quart Bottle	MT3018		
Ultra PAG Oil 46 - Drum (52 gal)	A10-6163		
<b>Fasteners</b>			
Retaining Ring - Clutch Pulley	F25-4112		
<b>Gaskets</b>			
Gasket - Front Head	Fiber G30-1124		
Gasket - Rear Head	Fiber G30-1123		
<b>Shaft Seals</b>			
Lip Seal	HNBR S25-1001		
<b>Tools</b>			
Shaft Seal Protector, Adjustable	T95-1228		

## DIESEL KIKI

### DKS13G (DUAL)

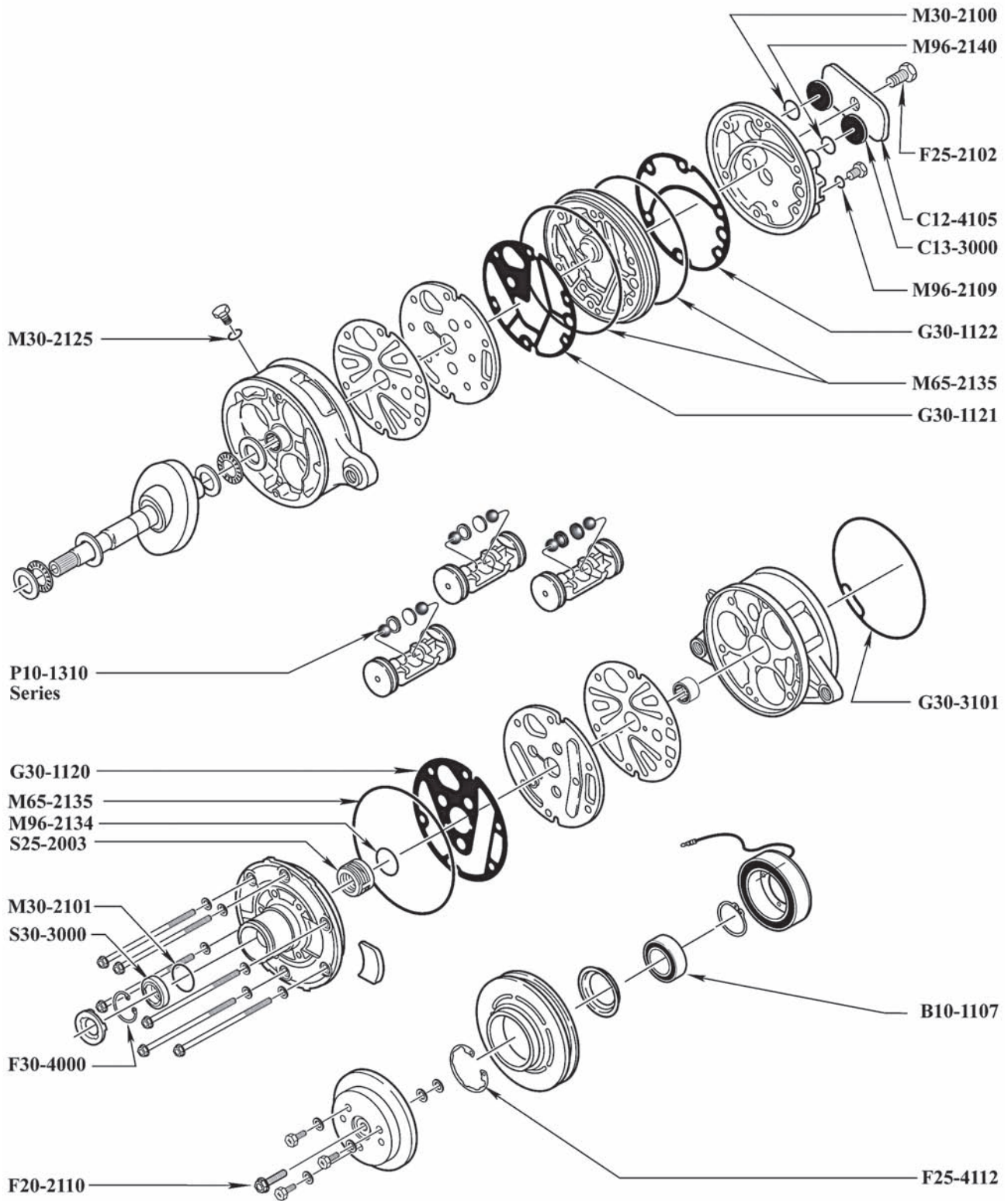



## DIESEL KIKI

### DKS13G (DUAL)

O-Rings	R134a and R-12 Compatible	Green HNBR	Black Nitrile
Carbon Shaft Seal O-Ring		<b>M96-2134</b>	<b>M96-1034</b>
Case O-Ring		<b>M65-2135</b>	<b>M65-1035</b>
Discharge Port O-Ring		<b>M96-2140</b>	<b>M96-1040</b>
Oil Drain Plug O-Ring		<b>M96-2109</b>	<b>M96-1009</b>
Oil Fill Plug O-Ring		<b>M30-2125</b>	
Shaft Seal Seat O-Ring		<b>M30-2101</b>	<b>M30-1001</b>
Suction Port O-Ring		<b>M30-2100</b>	<b>M30-1000</b>

#### Bearings

Case Bearing (16.3mm x 22mm x 16mm)	<b>B11-2110</b>
Clutch Bearing (35mm x 55mm x 20mm)	<b>B10-1107</b>

#### Chemicals

Ultra PAG Oil 46 - 6pk, 8 oz Bottle	<b>MT3012</b>
Ultra PAG Oil 46 - 6pk, Quart Bottle	<b>MT3018</b>
Ultra PAG Oil 46 - Drum (52 gal)	<b>A10-6163</b>

#### Fasteners

Bolt - Shaft	<b>F20-2110</b>
Bolt - Shipping Plate	<b>F25-2102</b>
Retaining Ring - Clutch Pulley	<b>F25-4112</b>
Retaining Ring - Shaft Seal Seat	<b>F30-4000</b>

#### Gaskets

Gasket - Front Head	Fiber <b>G30-1120</b>
Gasket - Intermediate Head	Fiber <b>G30-1121</b>
Gasket - Rear Head	Fiber <b>G30-1122</b>
Gasket - Center Case	Green HNBR <b>G30-3101</b>
Gasket Kit (Fiber)	Green HNBR <b>K30-2115</b>



*Includes: Gaskets: Front Head(1), Rear Head(1), Intermediate Head(1), Center Case Molded(1); O-Rings: Case(3); Oil Fill Plug(1), Oil Drain Plug(1), Carbon Shaft Seal(1), Metal Shaft Seal Seat(1), Discharge Port O-Ring (1), Suction Port O-Ring (1).*

#### Piston Components

Piston Ball (13.49mm) (Standard)	<b>P10-1310</b>
Piston Ball (13.50mm) (Oversize)	<b>P10-1315</b>
Piston Ball (13.51mm) (Oversize)	<b>P10-1320</b>

#### Shaft Seals

Carbon Shaft Seal	Nitrile <b>S25-2003</b>
Metal Shaft Seal Seat	<b>S30-3000</b>

#### Shaft Seals

Carbon Shaft Seal Kit	Green HNBR <b>K30-3105</b>
-----------------------	----------------------------



*Includes: Shaft Seal Retaining Ring (1), Carbon Shaft Seal (1), Metal Shaft Seal Seat (1), Metal Shaft Seal Seat O-Ring (1)*

#### Shipping Closures

Shipping Pad (Use with C12-4105)	<b>C13-3000</b>
Shipping Plate (Use with 2 C13-3000)	<b>C12-4105</b>

#### Tools

Shaft Seal Protector	<b>T11-1000</b>
Shaft Seal Protector, Adjustable	<b>T95-1228</b>

## DIESEL KIKI DKS13G (SINGLE)

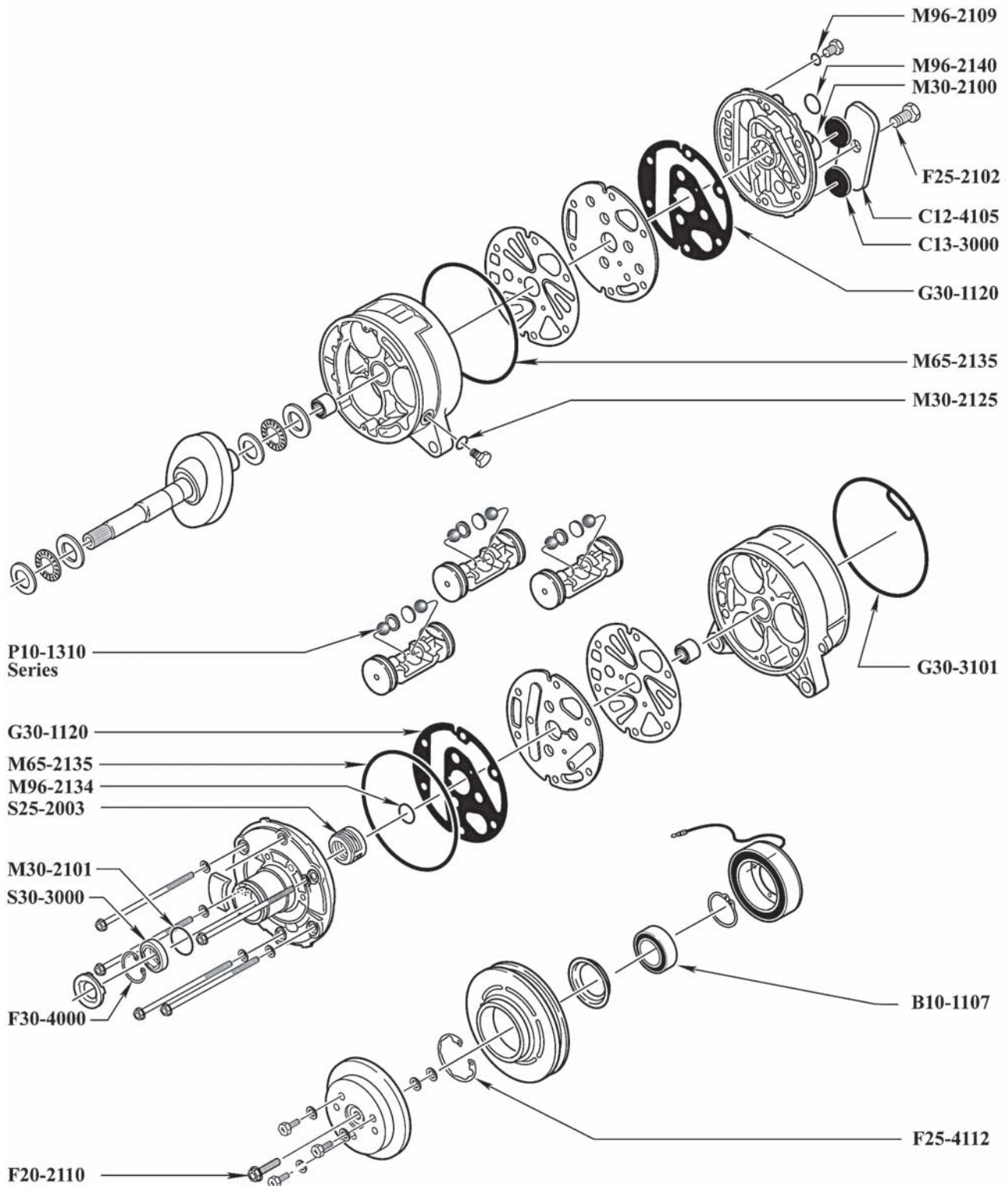

## DIESEL KIKI

### DKS13G (SINGLE)

O-Rings	R134a and R-12 Compatible	Green HNBR	Black Nitrile
Carbon Shaft Seal O-Ring		<b>M96-2134</b>	<b>M96-1034</b>
Case O-Ring		<b>M65-2135</b>	<b>M65-1035</b>
Discharge Port O-Ring		<b>M96-2140</b>	<b>M96-1040</b>
Oil Drain Plug O-Ring		<b>M96-2109</b>	<b>M96-1009</b>
Oil Fill Plug O-Ring		<b>M30-2125</b>	
Shaft Seal Seat O-Ring		<b>M30-2101</b>	<b>M30-1001</b>
Suction Port O-Ring		<b>M30-2100</b>	<b>M30-1000</b>

#### Bearings

Case Bearing (16.3mm x 22mm x 16mm)	<b>B11-2110</b>
Clutch Bearing (35mm x 55mm x 20mm)	<b>B10-1107</b>

#### Chemicals

Ultra PAG Oil 46 - 6pk, 8 oz Bottle	<b>MT3012</b>
Ultra PAG Oil 46 - 6pk, Quart Bottle	<b>MT3018</b>
Ultra PAG Oil 46 - Drum (52 gal)	<b>A10-6163</b>

#### Fasteners

Bolt - Shaft	<b>F20-2110</b>
Bolt - Shipping Plate	<b>F25-2102</b>
Retaining Ring - Clutch Pulley	<b>F25-4112</b>
Retaining Ring - Shaft Seal Seat	<b>F30-4000</b>

#### Gaskets

Gasket - Head	Fiber <b>G30-1120</b>
Gasket - Center Case	Green HNBR <b>G30-3101</b>
Gasket Kit (Fiber)	Green HNBR <b>K30-2116</b>

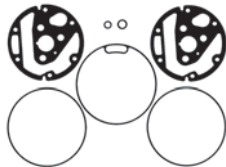

*Includes: Head Gasket (2), Center Case Molded Gasket (HNBR) (1), Oil Fill Plug O-Ring (1), Case O-Ring (2), Oil Drain Plug O-Ring (1).*

#### Piston Components

Piston Ball (13.49mm) (Standard)	<b>P10-1310</b>
Piston Ball (13.50mm) (Oversize)	<b>P10-1315</b>
Piston Ball (13.51mm) (Oversize)	<b>P10-1320</b>

#### Shaft Seals

Carbon Shaft Seal	Nitrile <b>S25-2003</b>
Metal Shaft Seal Seat	<b>S30-3000</b>

#### Shaft Seals

Carbon Shaft Seal Kit	Green HNBR <b>K30-3105</b>
-----------------------	----------------------------



*Includes: Shaft Seal Retaining Ring (1), Carbon Shaft Seal (1), Metal Shaft Seal Seat (1), Metal Shaft Seal Seat O-Ring (1)*

#### Shipping Closures

Shipping Pad (Use with C12-4105)	<b>C13-3000</b>
Shipping Plate (Use with 2 C13-3000)	<b>C12-4105</b>

#### Tools

Shaft Seal Protector	<b>T11-1000</b>
Shaft Seal Protector, Adjustable	<b>T95-1228</b>

## DIESEL KIKI

### DKS13S

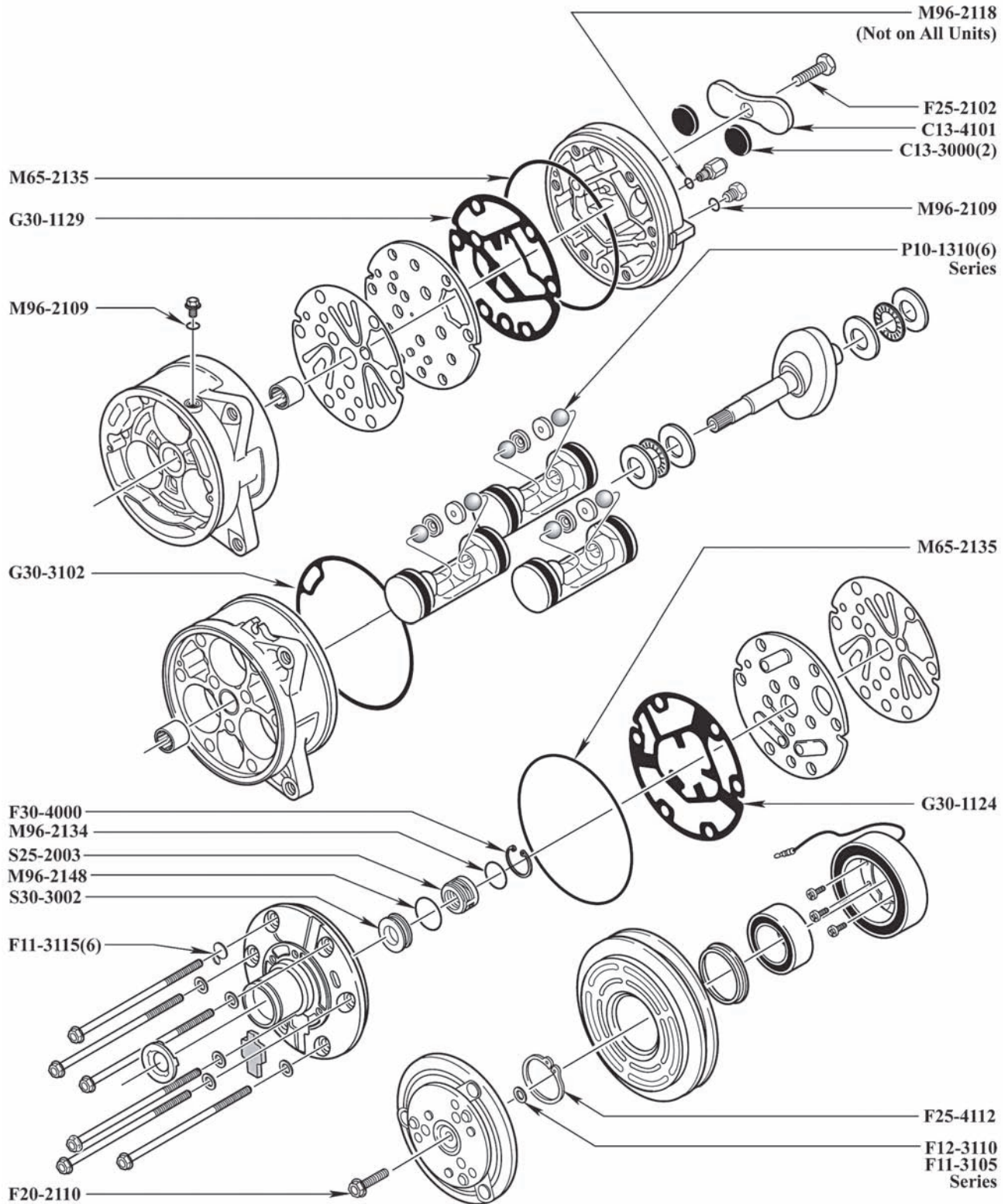

## DIESEL KIKI

### DKS13S

O-Rings	R134a and R-12 Compatible	Green HNBR	Black Nitrile
Carbon Shaft Seal O-Ring		<b>M96-2134</b>	<b>M96-1034</b>
Case O-Ring		<b>M65-2135</b>	<b>M65-1035</b>
High Pressure Relief Valve O-Ring		<b>M96-2118</b>	<b>M96-1018</b>
Oil Drain Plug O-Ring		<b>M96-2109</b>	<b>M96-1009</b>
Shaft Seal Seat O-Ring		<b>M96-2148</b>	<b>M96-1048</b>

#### Bearings

Case Bearing (16.3mm x 22mm x 16mm)	<b>B11-2110</b>
Clutch Bearing (35mm x 55mm x 20mm)	<b>B10-1107</b>

#### Chemicals

Ultra PAG Oil 100 - 6pk, 8 oz Bottle	<b>MT3013</b>
Ultra PAG Oil 100 - 6pk, Quart Bottle	<b>MT3019</b>
Ultra PAG Oil 100 - Drum (52 gal)	<b>A10-6164</b>

#### Fasteners

Bolt - Shaft	<b>F20-2110</b>
Bolt - Shipping Plate	<b>F25-2102</b>
Retaining Ring - Clutch Pulley	<b>F25-4112</b>
Retaining Ring - Shaft Seal Seat	<b>F30-4000</b>
Shim - Clutch (0.20mm)	<b>F11-3105</b>
Shim - Clutch (0.38mm)	<b>F12-3110</b>
Shim - Clutch (0.51mm)/Head Bolt Washer	<b>F11-3115</b>

#### Gaskets

Gasket - Front Head	Fiber <b>G30-1124</b>
Gasket - Rear Head	Fiber <b>G30-1129</b>
Gasket - Center Case	Green HNBR <b>G30-3102</b>
Gasket Kit (Fiber)	Green HNBR <b>K30-2126</b>



Includes: Front Head Gasket (1), Rear Head Gasket (1), Center Case Molded Gasket (HNBR) (1), Case O-Ring (2), Oil Drain/Oil Fill Plug O-Ring (2) Carbon Shaft Seal O-Ring (1), Metal Shaft Seal Seat O-Ring (1), High Pressure Relief Valve O-Ring (1).

#### Piston Components

Piston Ball (13.49mm) (Standard)	<b>P10-1310</b>
Piston Ball (13.50mm) (Oversize)	<b>P10-1315</b>
Piston Ball (13.51mm) (Oversize)	<b>P10-1320</b>

#### Shaft Seals

Carbon Shaft Seal	Nitrile <b>S25-2003</b>
Metal Shaft Seal Seat	<b>S30-3002</b>

#### Shaft Seals

Carbon Shaft Seal Kit Green HNBR **K30-3107**



Includes: Shaft Seal Retaining Ring (1), Carbon Shaft Seal (1), Metal Shaft Seal Seat (1), Metal Shaft Seal Seat O-Ring (1)

#### Shipping Closures

Shipping Pad (Use with C13-4101)	<b>C13-3000</b>
Shipping Plate (Rounded) (Use with 2 C13-3000)	<b>C13-4101</b>

#### Tools

Clutch Puller (3 Screw)	<b>T25-1000</b>
Shaft Seal Protector	<b>T11-1000</b>
Shaft Seal Protector, Adjustable	<b>T95-1228</b>

## DIESEL KIKI DKS15BH

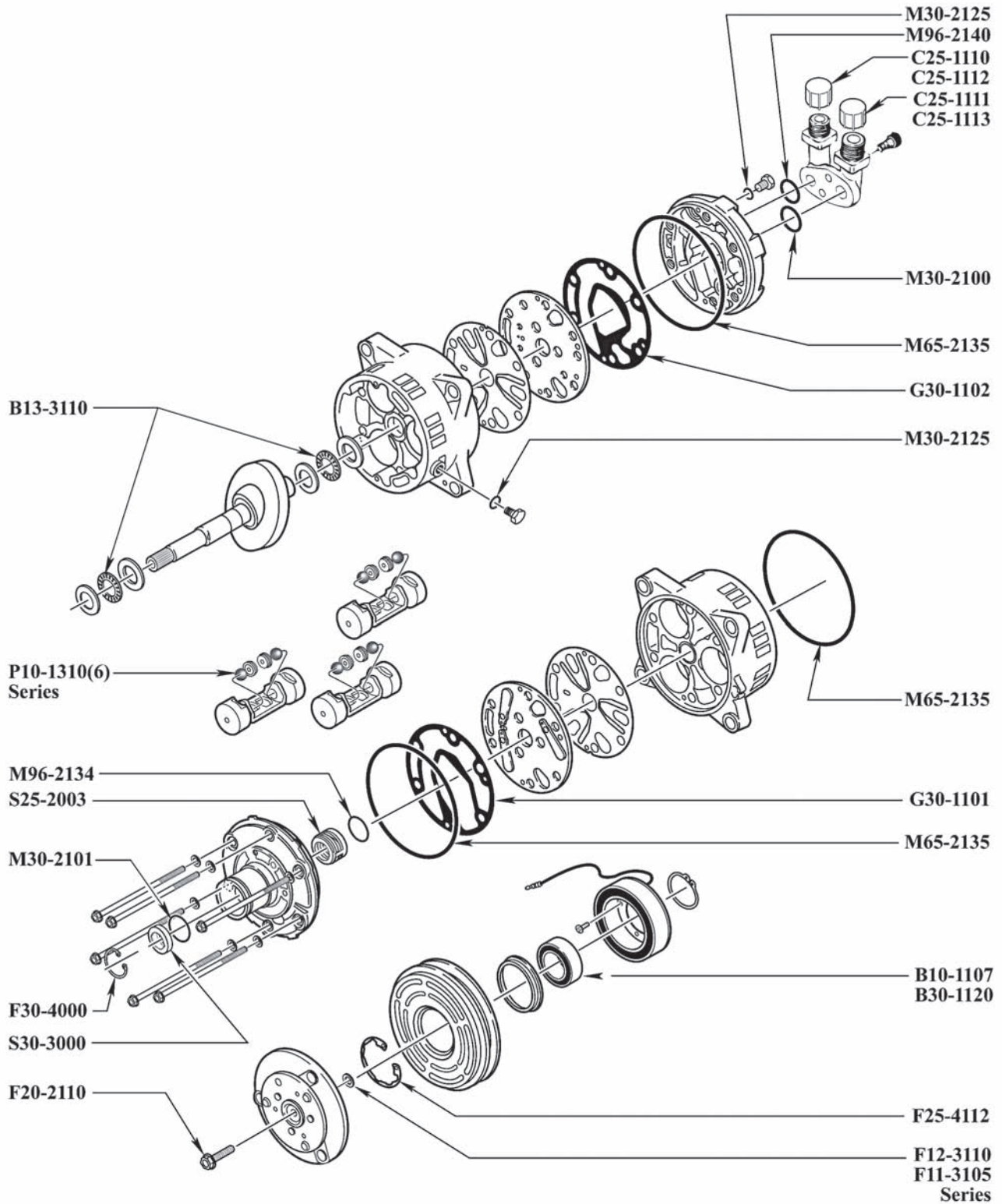

## DIESEL KIKI

### DKS15BH

O-Rings	R134a and R-12 Compatible	Green HNBR	Black Nitrile
Carbon Shaft Seal O-Ring		<b>M96-2134</b>	<b>M96-1034</b>
Case O-Ring		<b>M65-2135</b>	<b>M65-1035</b>
Discharge Port O-Ring		<b>M96-2140</b>	<b>M96-1040</b>
Oil Drain Plug O-Ring		<b>M30-2125</b>	
Shaft Seal Seat O-Ring		<b>M30-2101</b>	<b>M30-1001</b>
Suction Port O-Ring		<b>M30-2100</b>	<b>M30-1000</b>

#### Bearings

Clutch Bearing (35mm x 55mm x 20mm)	<b>B10-1107</b>
Clutch Bearing (35mm x 62mm x 28mm)	<b>B30-1120</b>
Thrust Bearing (19.2mm x 37.2mm x 2mm)	<b>B13-3110</b>

#### Chemicals

Ultra PAG Oil 100 - 6pk, 8 oz Bottle	<b>MT3013</b>
Ultra PAG Oil 100 - 6pk, Quart Bottle	<b>MT3019</b>
Ultra PAG Oil 100 - Drum (52 gal)	<b>A10-6164</b>

#### Electrical

Clutch Coil Assembly w/Diode	<b>E10-3000</b>
------------------------------	-----------------

#### Fasteners

Bolt - Shaft	<b>F20-2110</b>
Rivet - Valve Plate	<b>F13-7105</b>
Retaining Ring - Clutch Pulley	<b>F25-4112</b>
Retaining Ring - Shaft Seal Seat	<b>F30-4000</b>
Shim - Clutch (0.20mm)	<b>F11-3105</b>
Shim - Clutch (0.38mm)	<b>F12-3110</b>
Shim - Clutch (0.51mm)	<b>F11-3115</b>

#### Gaskets

Gasket - Front Head	Fiber <b>G30-1101</b>
Gasket - Rear Head	Fiber <b>G30-1102</b>
Gasket Kit (Fiber)	Green HNBR <b>K30-2105</b>



Includes: Front Head Gasket (1), Rear Head Gasket (1), Oil Fill/Drain Plug O-Ring (2), Case O-Ring (3), Discharge Port O-Ring (1), Suction Port O-Ring (1), Metal Shaft Seal Seat O-Ring (1)

#### Gaskets

Gasket Kit (Fiber)	Black Nitrile <b>K30-2005</b>
--------------------	-------------------------------

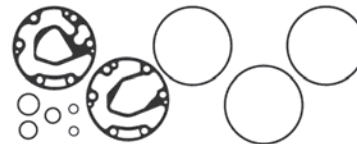

Includes: Front Head Gasket (1), Rear Head Gasket (1), Oil Fill/Drain Plug O-Ring (2), Case O-Ring (3), Discharge Port O-Ring (1), Suction Port O-Ring (1), Metal Shaft Seal Seat O-Ring (1)

#### Piston Components

Piston Ball (13.49mm) (Standard)	<b>P10-1310</b>
Piston Ball (13.50mm) (Oversize)	<b>P10-1315</b>
Piston Ball (13.51mm) (Oversize)	<b>P10-1320</b>

#### Shaft Seals

Carbon Shaft Seal	Nitrile <b>S25-2003</b>
Metal Shaft Seal Seat	<b>S30-3000</b>
Carbon Shaft Seal Kit	Green HNBR <b>K30-3105</b>



Includes: Shaft Seal Retaining Ring (1), Carbon Shaft Seal (1), Metal Shaft Seal Seat (1), Metal Shaft Seal Seat O-Ring (1)

#### Shipping Closures

Discharge Cap w/ O-Ring - 4/5" (.800") Height	<b>C25-1112</b>
Discharge Cap w/ O-Ring - 5/8" (.625") Height	<b>C25-1110</b>
Suction Cap w/ Disc - 1" Height	<b>C25-1113</b>
Suction Cap w/ Disc - 7/9" (.701") Height	<b>C25-1111</b>

#### Tools

Clutch Puller (3 Screw)	<b>T25-1000</b>
Shaft Seal Protector, Adjustable	<b>T95-1228</b>

## DIESEL KIKI

### DKS15CH

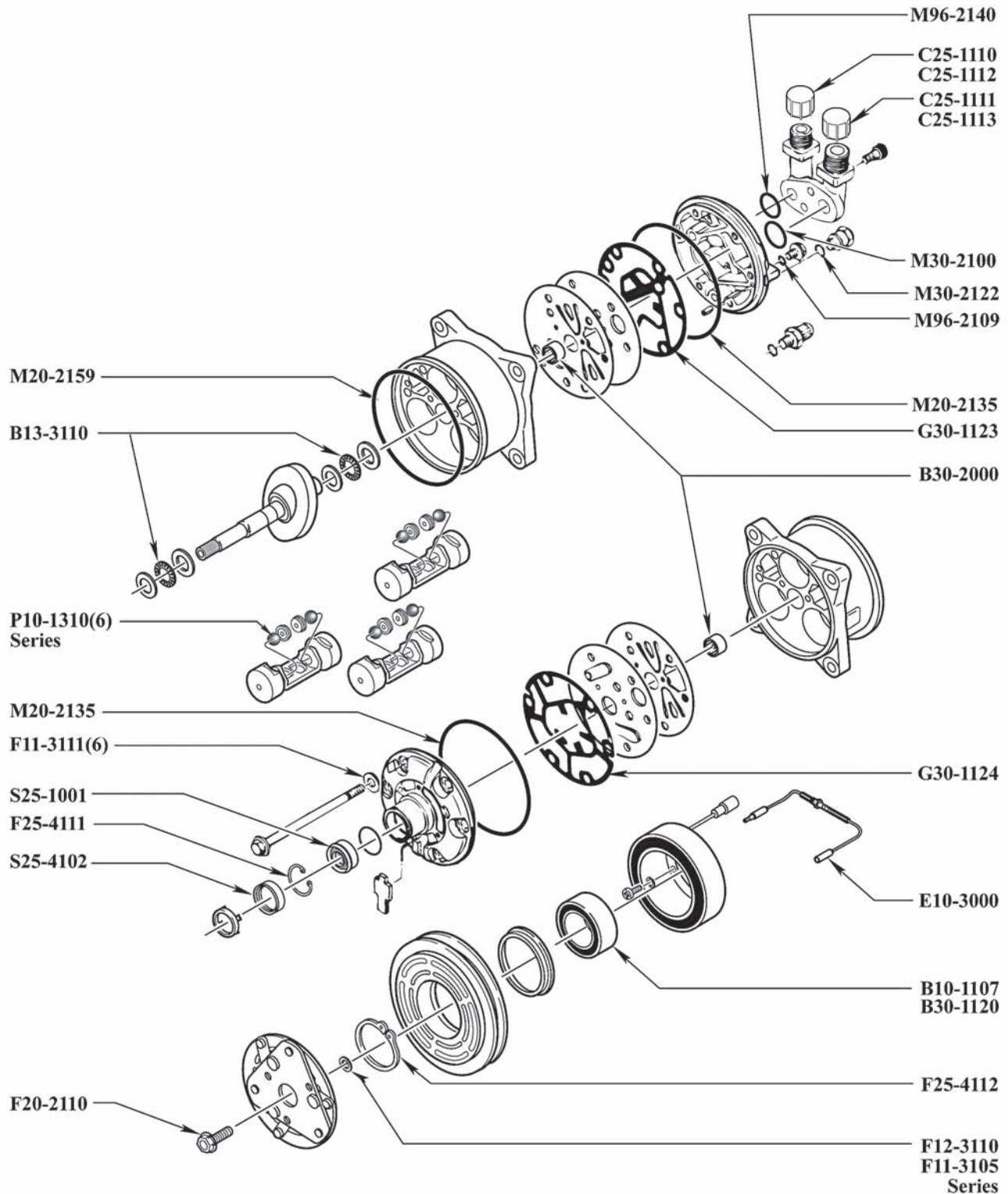



## DIESEL KIKI

### DKS15CH

O-Rings	R134a and R-12 Compatible	Green HNBR	Black Nitrile
Case O-Ring (Center)		<b>M20-2159</b>	<b>M20-1059</b>
Case O-Ring (Front and Rear)		<b>M20-2135</b>	<b>M20-1035</b>
Discharge Port O-Ring		<b>M96-2140</b>	<b>M96-1040</b>
Lip Seal / Suction Port O-Ring		<b>M30-2100</b>	<b>M30-1000</b>
Oil Drain Plug O-Ring		<b>M96-2109</b>	<b>M96-1009</b>
Pressure Relief Valve O-Ring		<b>M30-2122</b>	

#### Bearings

Case Bearing (16mm x 22mm x 20mm)	<b>B30-2000</b>
Clutch Bearing (35mm x 55mm x 20mm)	<b>B10-1107</b>
Clutch Bearing (35mm x 62mm x 28mm)	<b>B30-1120</b>
Thrust Bearing (19.2mm x 37.2mm x 2mm)	<b>B13-3110</b>

#### Chemicals

Ultra PAG Oil 46 - 6pk, 8 oz Bottle	<b>MT3012</b>
Ultra PAG Oil 46 - 6pk, Quart Bottle	<b>MT3018</b>
Ultra PAG Oil 46 - Drum (52 gal)	<b>A10-6163</b>

#### Electrical

Clutch Coil Assembly w/Diode	<b>E10-3000</b>
------------------------------	-----------------

#### Fasteners

Bolt - Shaft	<b>F20-2110</b>
Retaining Ring - Clutch Pulley	<b>F25-4112</b>
Retaining Ring - Lip Seal	<b>F25-4111</b>
Shim - Clutch (0.20mm)	<b>F11-3105</b>
Shim - Clutch (0.38mm)	<b>F12-3110</b>
Shim - Clutch (0.51mm)	<b>F11-3115</b>
Washer - Head Bolt	<b>F11-3111</b>

#### Gaskets

Gasket - Front Head	Fiber <b>G30-1124</b>
Gasket - Rear Head	Fiber <b>G30-1123</b>
Gasket Kit (Fiber)	Green HNBR <b>K30-2112</b>

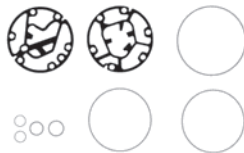

Includes: Front Head Gasket (1), Rear Head Gasket (1), Case O-Ring (Center) (1), Case O-Ring (Front and Rear) (2), Oil Plug O-Ring (1), Pressure Relief Valve O-Ring (1), Discharge Port O-Ring (1), Suction Port O-Ring (1)

#### Gaskets

Gasket Kit (Fiber) Black Nitrile **K30-2012**

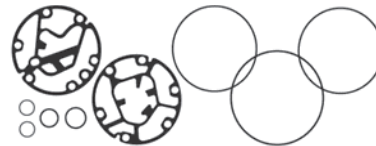

Includes: Front Head Gasket (1), Rear Head Gasket (1), Case O-Ring (Center) (1), Case O-Ring (Front and Rear) (2), Oil Plug O-Ring (1), Pressure Relief Valve O-Ring (1), Discharge Port O-Ring (1), Suction Port O-Ring (1)

#### Piston Components

Piston Ball (13.49mm) (Standard)	<b>P10-1310</b>
Piston Ball (13.50mm) (Oversize)	<b>P10-1315</b>
Piston Ball (13.51mm) (Oversize)	<b>P10-1320</b>

#### Shaft Seals

Felt Ring	<b>S25-4102</b>
Lip Seal	HNBR <b>S25-1001</b>
Lip Seal Kit	Black Nitrile <b>K25-3156</b>



Includes: Lip Seal (1), Lip Seal Felt Ring (1), Lip Seal Retaining Ring (1)

#### Shipping Closures

Cap - 1/4" Low Side	<b>C10-1000</b>
Cap - 7/16" Service Port (Permanent)	<b>C10-1120</b>
Discharge Cap w/ O-Ring - 4/5" (.800") Height	<b>C25-1112</b>
Discharge Cap w/ O-Ring - 5/8" (.625") Height	<b>C25-1110</b>
Suction Cap w/ Disc - 1" Height	<b>C25-1113</b>
Suction Cap w/ Disc - 7/9" (.701") Height	<b>C25-1111</b>

#### Tools

Clutch Puller (3 Screw)	<b>T25-1000</b>
Shaft Seal Protector	<b>T25-1037</b>
Shaft Seal Protector, Adjustable	<b>T95-1228</b>

## DIESEL KIKI DKS15G

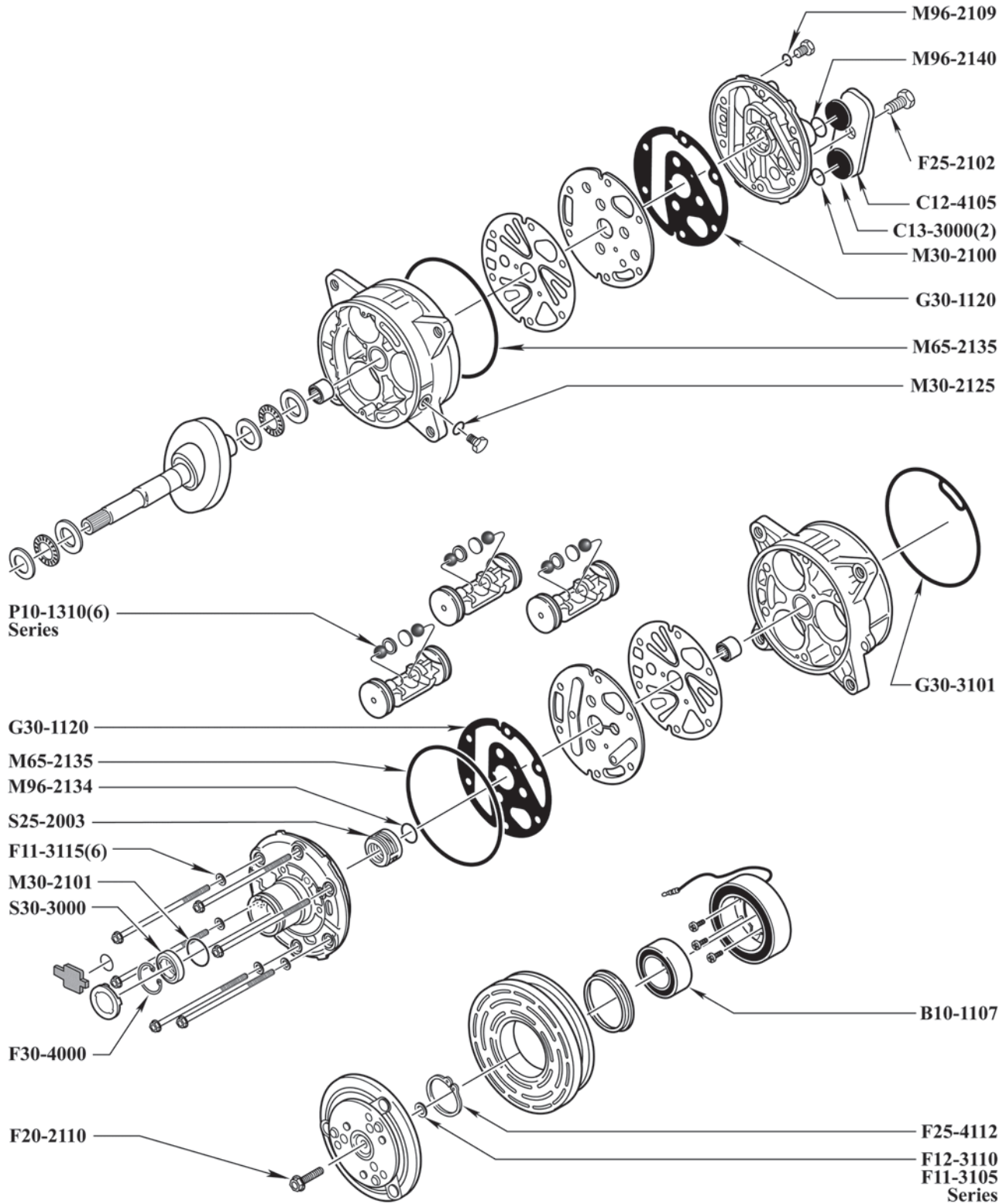

## DIESEL KIKI

### DKS15G

O-Rings	R134a and R-12 Compatible	Green HNBR	Black Nitrile
Carbon Shaft Seal O-Ring		<b>M96-2134</b>	<b>M96-1034</b>
Case O-Ring		<b>M65-2135</b>	<b>M65-1035</b>
Discharge Port O-Ring		<b>M96-2140</b>	<b>M96-1040</b>
Oil Drain Plug O-Ring		<b>M96-2109</b>	<b>M96-1009</b>
Oil Fill Plug O-Ring		<b>M30-2125</b>	
Shaft Seal Seat O-Ring		<b>M30-2101</b>	<b>M30-1001</b>
Suction Port O-Ring		<b>M30-2100</b>	<b>M30-1000</b>

#### Bearings

Case Bearing (16.3mm x 22mm x 16mm)	<b>B11-2110</b>
Clutch Bearing (35mm x 55mm x 20mm)	<b>B10-1107</b>

#### Chemicals

Ultra PAG Oil 100 - 6pk, 8 oz Bottle	<b>MT3013</b>
Ultra PAG Oil 100 - 6pk, Quart Bottle	<b>MT3019</b>
Ultra PAG Oil 100 - Drum (52 gal)	<b>A10-6164</b>

#### Fasteners

Bolt - Shaft	<b>F20-2110</b>
Bolt - Shipping Plate	<b>F25-2102</b>
Retaining Ring - Clutch Pulley	<b>F25-4112</b>
Retaining Ring - Shaft Seal Seat	<b>F30-4000</b>
Shim - Clutch (0.20mm)	<b>F11-3105</b>
Shim - Clutch (0.38mm)	<b>F12-3110</b>
Shim - Clutch (0.51mm)/Head Bolt Washer	<b>F11-3115</b>

#### Gaskets

Gasket - Head	Fiber <b>G30-1120</b>
Gasket - Center Case	Green HNBR <b>G30-3101</b>
Gasket Kit (Fiber)	Green HNBR <b>K30-2116</b>

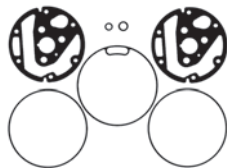

Includes: Head Gasket (2), Center Case Molded Gasket (HNBR) (1), Oil Fill Plug O-Ring (1), Case O-Ring (2), Oil Drain Plug O-Ring (1).

#### Piston Components

Piston Ball (13.49mm) (Standard)	<b>P10-1310</b>
Piston Ball (13.50mm) (Oversize)	<b>P10-1315</b>
Piston Ball (13.51mm) (Oversize)	<b>P10-1320</b>

#### Shaft Seals

Carbon Shaft Seal	Nitrile <b>S25-2003</b>
Metal Shaft Seal Seat	<b>S30-3000</b>

#### Shaft Seals

Carbon Shaft Seal Kit	Green HNBR <b>K30-3105</b>
-----------------------	----------------------------



Includes: Shaft Seal Retaining Ring (1), Carbon Shaft Seal (1), Metal Shaft Seal Seat (1), Metal Shaft Seal Seat O-Ring (1)

#### Shipping Closures

Shipping Pad (Use with C12-4105)	<b>C13-3000</b>
Shipping Plate (Use with 2 C13-3000)	<b>C12-4105</b>

#### Tools

Shaft Seal Protector	<b>T11-1000</b>
Shaft Seal Protector, Adjustable	<b>T95-1228</b>

## DIESEL KIKI DKS15S

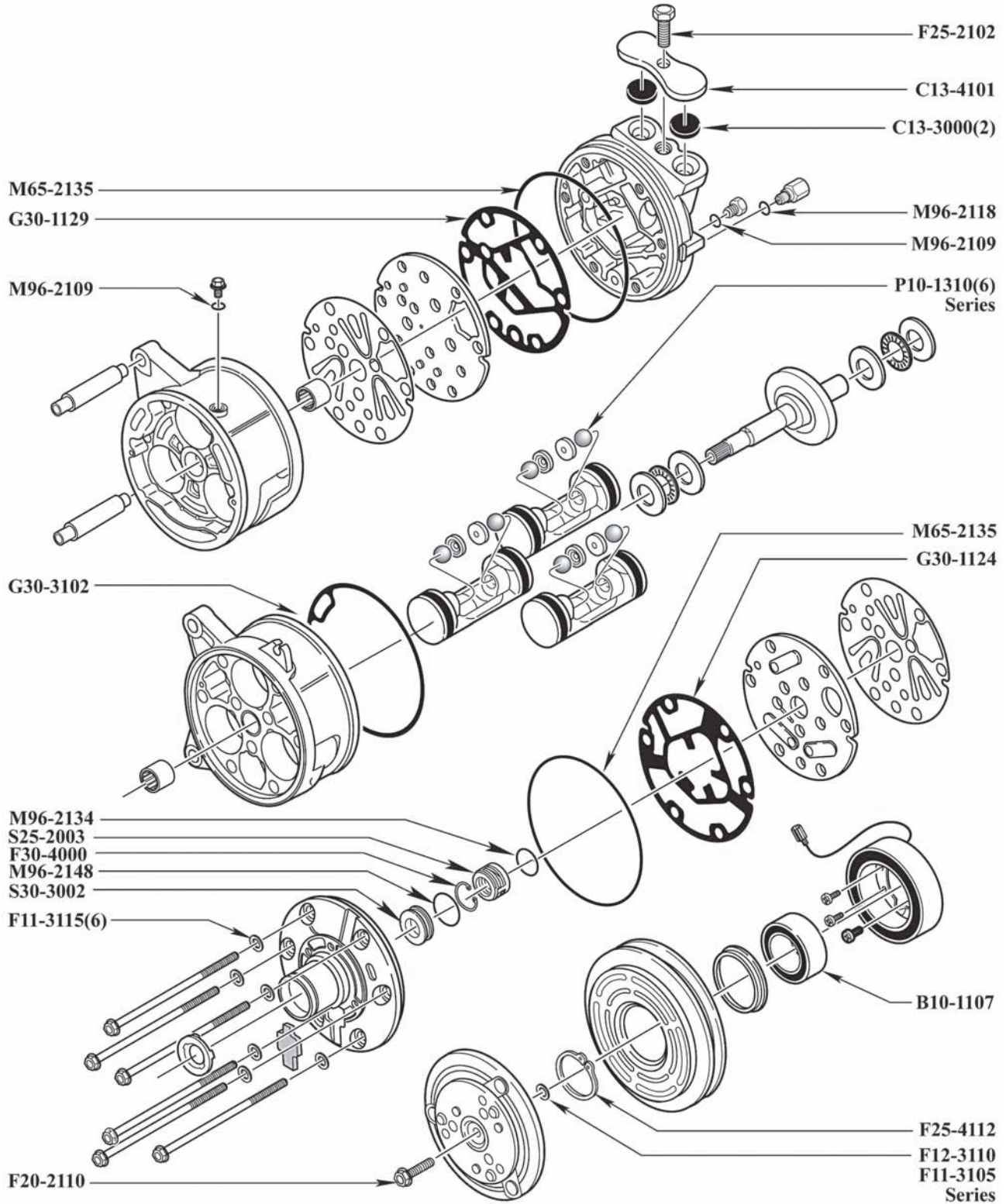

## DIESEL KIKI

### DKS15S

O-Rings	R134a and R-12 Compatible	Green HNBR	Black Nitrile
Carbon Shaft Seal O-Ring		<b>M96-2134</b>	<b>M96-1034</b>
Case O-Ring		<b>M65-2135</b>	<b>M65-1035</b>
High Pressure Relief Valve O-Ring		<b>M96-2118</b>	<b>M96-1018</b>
Oil Drain Plug O-Ring		<b>M96-2109</b>	<b>M96-1009</b>
Shaft Seal Seat O-Ring		<b>M30-2101</b>	<b>M30-1001</b>
Shaft Seal Seat O-Ring		<b>M96-2148</b>	<b>M96-1048</b>

#### Bearings

Case Bearing (16.3mm x 22mm x 16mm)	<b>B11-2110</b>
Clutch Bearing (35mm x 55mm x 20mm)	<b>B10-1107</b>

#### Chemicals

Ultra PAG Oil 100 - 6pk, 8 oz Bottle	<b>MT3013</b>
Ultra PAG Oil 100 - 6pk, Quart Bottle	<b>MT3019</b>
Ultra PAG Oil 100 - Drum (52 gal)	<b>A10-6164</b>

#### Fasteners

Bolt - Shaft	<b>F20-2110</b>
Bolt - Shipping Plate	<b>F25-2102</b>
Retaining Ring - Clutch Pulley	<b>F25-4112</b>
Retaining Ring - Shaft Seal Seat	<b>F30-4000</b>
Shim - Clutch (0.20mm)	<b>F11-3105</b>
Shim - Clutch (0.38mm)	<b>F12-3110</b>
Shim - Clutch (0.51mm)\Head Bolt Washer	<b>F11-3115</b>

#### Gaskets

Gasket - Front Head	Fiber <b>G30-1124</b>
Gasket - Rear Head	Fiber <b>G30-1129</b>
Gasket - Center Case	Green HNBR <b>G30-3102</b>
Gasket Kit (Fiber)	Green HNBR <b>K30-2126</b>



*Includes: Front Head Gasket (1), Rear Head Gasket (1), Center Case Molded Gasket (HNBR) (1), Case O-Ring (2), Oil Drain/Oil Fill Plug O-Ring (2) Carbon Shaft Seal O-Ring (1), Metal Shaft Seal Seat O-Ring (1), High Pressure Relief Valve O-Ring (1).*

#### Piston Components

Piston Ball (13.49mm) (Standard)	<b>P10-1310</b>
Piston Ball (13.50mm) (Oversize)	<b>P10-1315</b>
Piston Ball (13.51mm) (Oversize)	<b>P10-1320</b>

#### Shaft Seals

Carbon Shaft Seal	Nitrile <b>S25-2003</b>
Metal Shaft Seal Seat	<b>S30-3002</b>

#### Shaft Seals

Carbon Shaft Seal Kit Green HNBR **K30-3107**



*Includes: Shaft Seal Retaining Ring (1), Carbon Shaft Seal (1), Metal Shaft Seal Seat (1), Metal Shaft Seal Seat O-Ring (1)*

#### Shipping Closures

Shipping Pad (Use with C13-4101)	<b>C13-3000</b>
Shipping Plate (Rounded) (Use with 2 C13-3000)	<b>C13-4101</b>

#### Tools

Clutch Puller (3 Screw)	<b>T25-1000</b>
Shaft Seal Protector, Adjustable	<b>T95-1228</b>

## DIESEL KIKI

### DKS16H(R12)

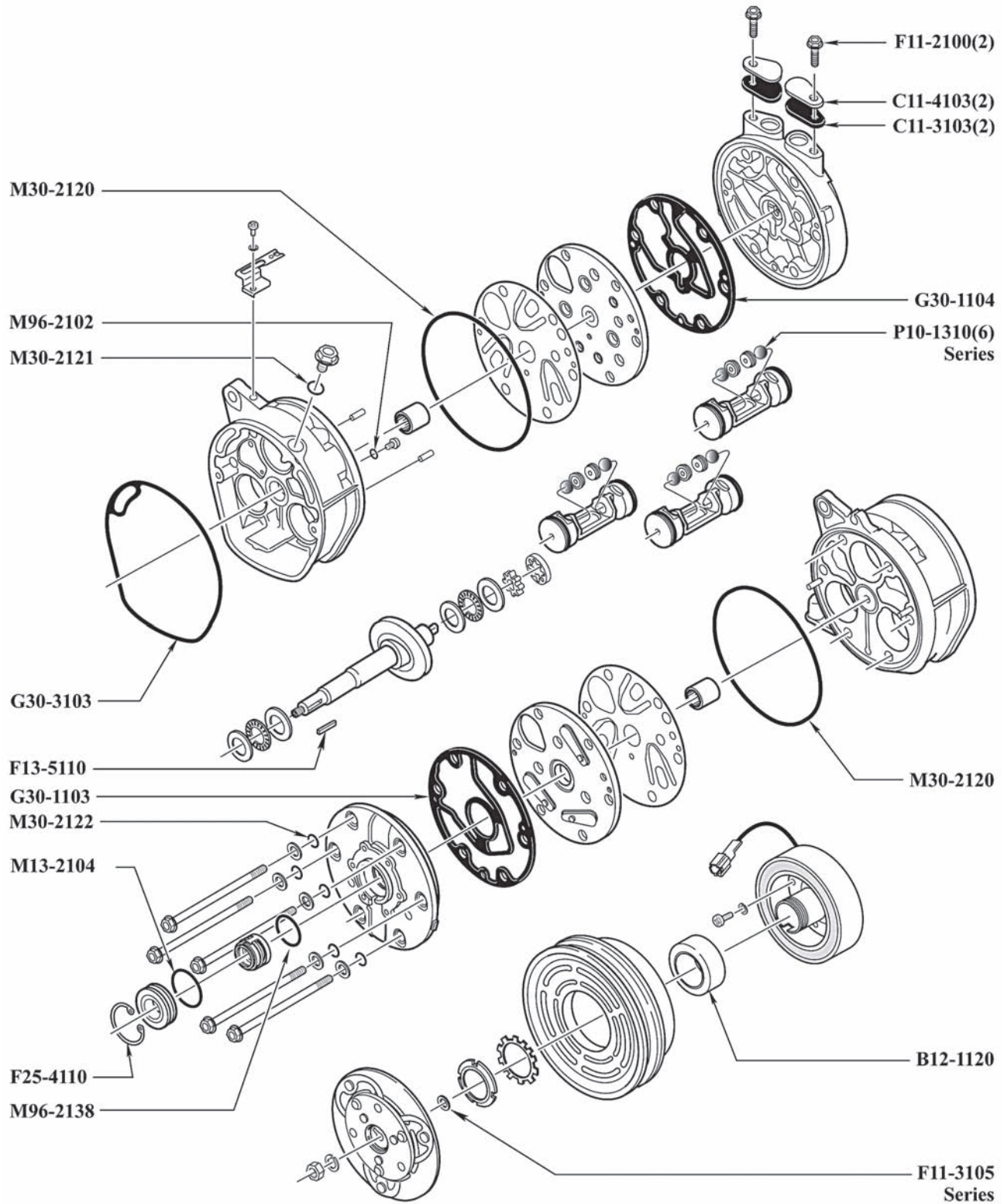

## DIESEL KIKI

### DKS16H(R12)

O-Rings	R134a and R-12 Compatible	Green HNBR	Black Nitrile
Carbon Shaft Seal O-Ring		<b>M96-2138</b>	<b>M96-1038</b>
Case O-Ring		<b>M30-2120</b>	
Head Bolt O-Ring		<b>M30-2122</b>	
Oil Drain Plug O-Ring		<b>M96-2102</b>	<b>M96-1002</b>
Oil Fill Plug O-Ring		<b>M30-2121</b>	
Shaft Seal Seat O-Ring		<b>M13-2104</b>	<b>M13-1004</b>
<b>Bearings</b>		<b>Shipping Closures</b>	
Clutch Bearing (30mm x 55mm x 23mm)	<b>B12-1120</b>	Shipping Plate (Use with C95-3002 & C95-3004)	<b>C95-4001</b>
<b>Chemicals</b>		Shipping Plug (Discharge) (Use with C95-4001)	<b>C95-3002</b>
Ultra PAG Oil 100 - 6pk, 8 oz Bottle	<b>MT3013</b>	Shipping Plug (Suction) (Use with C95-4001)	<b>C95-3004</b>
Ultra PAG Oil 100 - 6pk, Quart Bottle	<b>MT3019</b>	<b>Tools</b>	
Ultra PAG Oil 100 - Drum (52 gal)	<b>A10-6164</b>	Clutch Puller - Center Hub	<b>T45-1001</b>
<b>Fasteners</b>		Helical Insert Drill for 5/16-18 and 8-1.25mm Inserts	<b>T10-6554</b>
Bolt - Shipping Plate	<b>F11-2100</b>	Helical Insert Drill for 8-1.25mm Inserts	<b>T10-6053</b>
Helical Insert - Rear Head / Shipping Plate (8-1.25 x 12mm)	<b>F10-6211</b>	Helical Insert Tap 8-1.25mm	<b>T10-6254</b>
Shaft Key	<b>F13-5110</b>	Shaft Seal Protector	<b>T45-1002</b>
Retaining Ring (Beveled) - Shaft Seal Seat	<b>F25-4110</b>	Shaft Seal Protector, Adjustable	<b>T95-1230</b>
Shim - Clutch (0.20mm)	<b>F11-3105</b>	Helical Insert Repair Kit (8-1.25mm)	<b>K10-1180</b>
Shim - Clutch (0.51mm)	<b>F11-3115</b>		
<b>Gaskets</b>			
Gasket - Front Head	Fiber <b>G30-1103</b>		
Gasket - Rear Head	Fiber <b>G30-1104</b>		
Gasket - Center Case	Green HNBR <b>G30-3103</b>		
Gasket Kit (Fiber)	Green HNBR <b>K30-2120</b>		

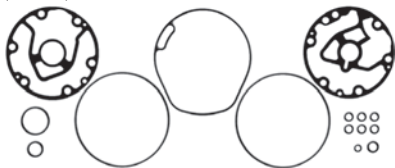

Includes: Front Head Gasket (1), Rear Head Gasket (1), Center Case Molded Gasket (1), Case O-Ring (2), Oil Fill Plug O-Ring (1), Oil Drain Plug O-Ring (1), Head Bolt O-Ring (6), Metal Shaft Seal Seat O-Ring (1), Carbon Shaft Seal O-Ring (1).



Includes: Helical Inserts (25), Drill (1), Tap (1), Installation Tool - Bolt Style (1)

#### Piston Components

Piston Ball (13.49mm) (Standard)	<b>P10-1310</b>
Piston Ball (13.50mm) (Oversize)	<b>P10-1315</b>
Piston Ball (13.51mm) (Oversize)	<b>P10-1320</b>
<b>Shipping Closures</b>	
Shipping Pad (Use with C11-4103)	<b>C11-3103</b>
Shipping Pad (Use with C50-4101)	<b>C50-3001</b>
Shipping Plate (Use with C11-3103)	<b>C11-4103</b>
Shipping Plate (Use with C50-3001)	<b>C50-4101</b>

## DIESEL KIKI

DKS16H(R134A)

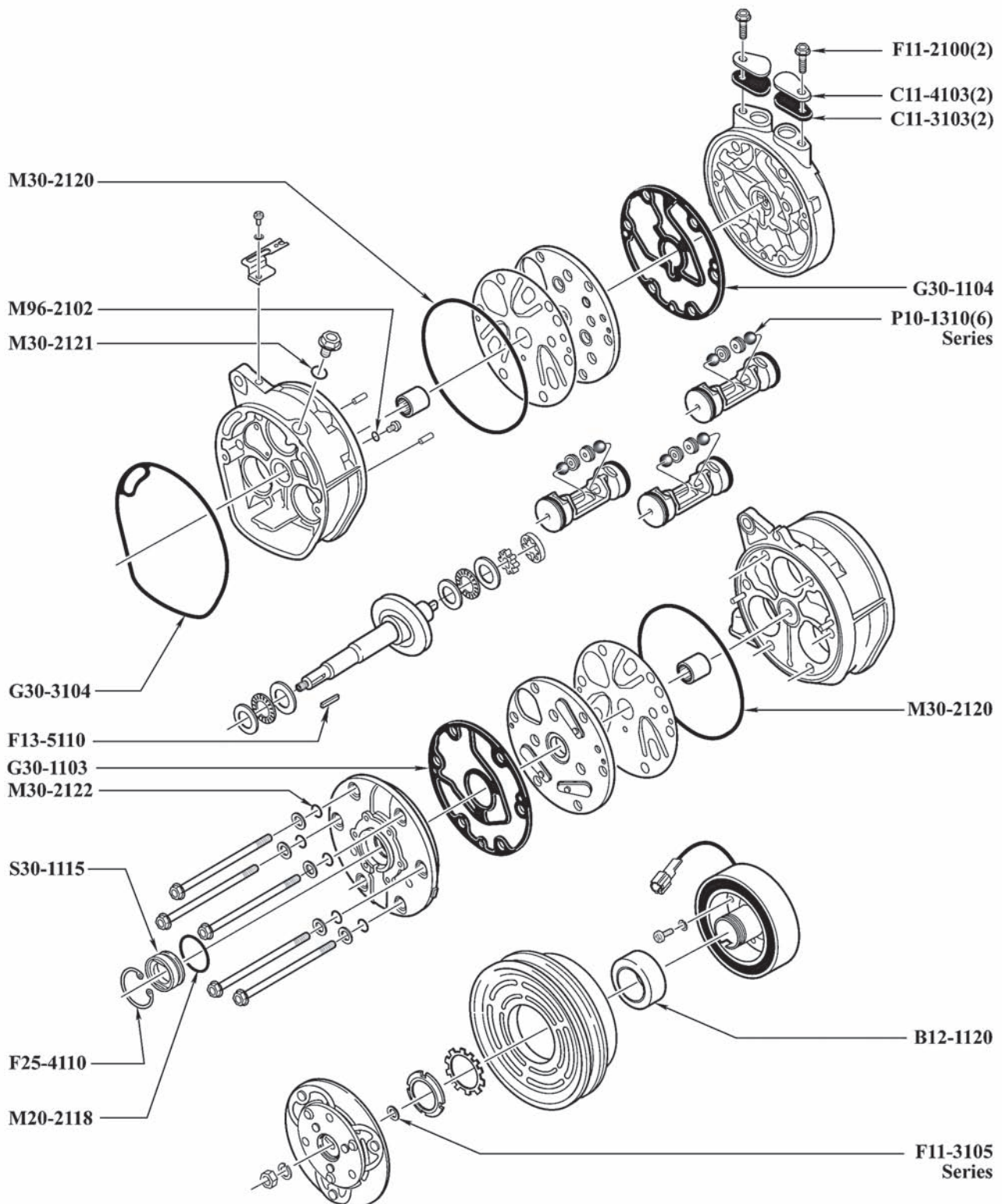



## DIESEL KIKI

### DKS16H(R134A)

O-Rings	R134a and R-12 Compatible	Green HNBR	Black Nitrile
Case O-Ring		<b>M30-2120</b>	
Head Bolt O-Ring		<b>M30-2122</b>	
Lip Seal O-Ring		<b>M20-2118</b>	<b>M20-1018</b>
Oil Drain Plug O-Ring		<b>M96-2102</b>	<b>M96-1002</b>
Oil Fill Plug O-Ring		<b>M30-2121</b>	

#### Bearings

Clutch Bearing (30mm x 55mm x 23mm) **B12-1120**

#### Chemicals

Ultra PAG Oil 100 - 6pk, 8 oz Bottle **MT3013**

Ultra PAG Oil 100 - 6pk, Quart Bottle **MT3019**

Ultra PAG Oil 100 - Drum (52 gal) **A10-6164**

#### Fasteners

Bolt - Shipping Plate **F11-2100**

Helical Insert - Rear Head / Shipping Plate (8-1.25 x 12mm) **F10-6211**

Shaft Key **F13-5110**

Retaining Ring (Beveled) - Lip Seal **F25-4110**

Shim - Clutch (0.20mm) **F11-3105**

Shim - Clutch (0.51mm) **F11-3115**

#### Gaskets

Gasket - Front Head Fiber **G30-1103**

Gasket - Rear Head Fiber **G30-1104**

Gasket - Center Case Green HNBR **G30-3104**

Gasket Kit (Fiber) Green HNBR **K30-2121**

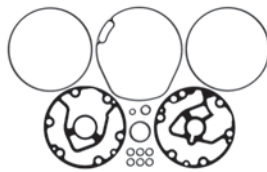

*Includes: Front Head Gasket (1), Rear Head Gasket (1), Center Case Molded Gasket (1), Case O-Ring (2), Oil Fill Plug O-Ring (1), Oil Drain Plug O-Ring (1), Head Bolt O-Ring (6), Lip Seal O-Ring (1)*

#### Piston Components

Piston Ball (13.49mm) (Standard) **P10-1310**

Piston Ball (13.50mm) (Oversize) **P10-1315**

Piston Ball (13.51mm) (Oversize) **P10-1320**

#### Shaft Seals

Lip Seal HNBR **S30-1115**

#### Shaft Seals

Lip Seal Kit Black Nitrile **K30-3006**



*Includes: Lip Seal Retaining Ring (1), Lip Seal (1)*

#### Shipping Closures

Shipping Pad (Use with C11-4103) **C11-3103**

Shipping Pad (Use with C50-4101) **C50-3001**

Shipping Plate (Use with C11-3103) **C11-4103**

Shipping Plate (Use with C50-3001) **C50-4101**

Shipping Plate (Use with C95-3003 & C95-3004) **C95-4001**

Shipping Plug (Discharge) (Use with C95-4001) **C95-3003**

Shipping Plug (Suction) (Use with C95-4001) **C95-3004**

#### Tools

Clutch Puller - Center Hub **T45-1001**

Helical Insert Drill for 5/16-18 and 8-1.25mm Inserts **T10-6554**

Helical Insert Drill for 8-1.25mm Inserts **T10-6053**

Helical Insert Tap 8-1.25mm **T10-6254**

Shaft Seal Protector **T45-1002**

Shaft Seal Protector, Adjustable **T95-1230**

Helical Insert Repair Kit (8-1.25mm) **K10-1180**



*Includes: Helical Inserts (25), Drill (1), Tap (1), Installation Tool - Bolt Style (1)*

## DIESEL KIKI

### DKS17CH

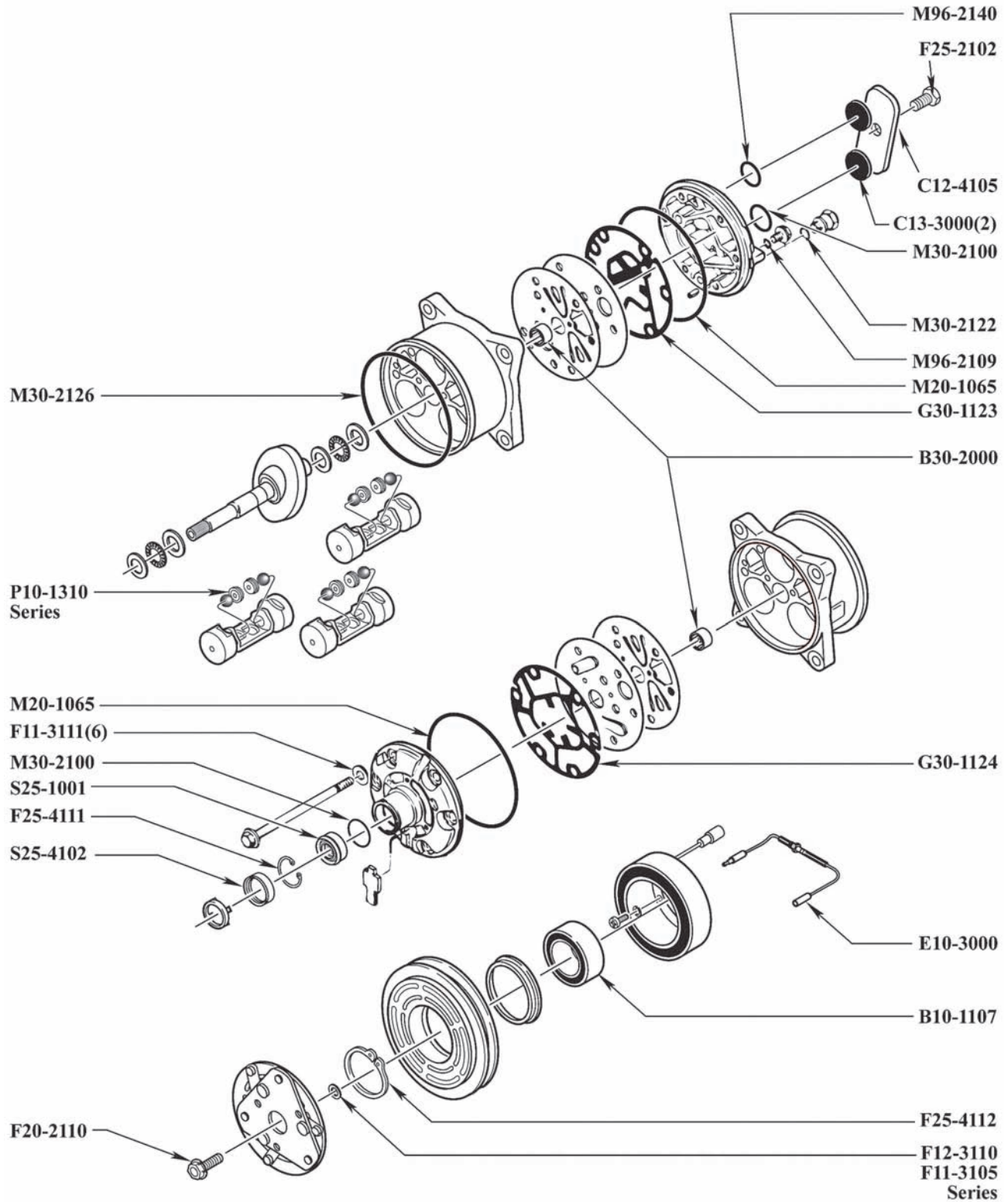

## DIESEL KIKI

### DKS17CH

O-Rings	R134a and R-12 Compatible	Green HNBR	Black Nitrile
Case O-Ring (Center)		<b>M30-2126</b>	
Case O-Ring (Front and Rear)			<b>M20-1065</b>
Discharge Port O-Ring		<b>M96-2140</b>	<b>M96-1040</b>
Lip Seal / Suction Port O-Ring		<b>M30-2100</b>	<b>M30-1000</b>
Oil Drain Plug O-Ring		<b>M96-2109</b>	<b>M96-1009</b>
Pressure Relief Valve O-Ring		<b>M30-2122</b>	
<b>Bearings</b>		<b>Shipping Closures</b>	
Case Bearing (16mm x 22mm x 20mm)	<b>B30-2000</b>	Shipping Pad (Use with C12-4105)	<b>C13-3000</b>
Clutch Bearing (35mm x 55mm x 20mm)	<b>B10-1107</b>	Shipping Plate (Use with 2 C13-3000)	<b>C12-4105</b>
<b>Chemicals</b>		<b>Tools</b>	
Ultra PAG Oil 46 - 6pk, 8 oz Bottle	<b>MT3012</b>	Shaft Seal Protector, Adjustable	<b>T95-1228</b>
Ultra PAG Oil 46 - 6pk, Quart Bottle	<b>MT3018</b>		
Ultra PAG Oil 46 - Drum (52 gal)	<b>A10-6163</b>		
<b>Electrical</b>			
Clutch Coil Assembly w/Diode	<b>E10-3000</b>		
<b>Fasteners</b>			
Bolt - Shaft	<b>F20-2110</b>		
Bolt - Shipping Plate	<b>F25-2102</b>		
Retaining Ring - Clutch Pulley	<b>F25-4112</b>		
Retaining Ring - Lip Seal	<b>F25-4111</b>		
Shim - Clutch (0.20mm)	<b>F11-3105</b>		
Shim - Clutch (0.38mm)	<b>F12-3110</b>		
Shim - Clutch (0.51mm)	<b>F11-3115</b>		
Washer - Head Bolt	<b>F11-3111</b>		
<b>Gaskets</b>			
Gasket - Front Head	Fiber <b>G30-1124</b>		
Gasket - Rear Head	Fiber <b>G30-1123</b>		
<b>Piston Components</b>			
Piston Ball (13.49mm) (Standard)	<b>P10-1310</b>		
Piston Ball (13.50mm) (Oversize)	<b>P10-1315</b>		
Piston Ball (13.51mm) (Oversize)	<b>P10-1320</b>		
<b>Shaft Seals</b>			
Felt Ring	<b>S25-4102</b>		
Lip Seal	HNBR <b>S25-1001</b>		
Lip Seal Kit	Black Nitrile <b>K25-3156</b>		



Includes: Lip Seal (1), Lip Seal Felt Ring (1), Lip Seal Retaining Ring (1).

## **DIESEL KIKI**

**DKS17D**

## DIESEL KIKI

DKS17D

O-Rings	R134a and R-12 Compatible	Green HNBR	Black Nitrile
---------	---------------------------	------------	---------------

Pressure Relief Valve O-Ring

**M96-2113**

### Bearings

Clutch Bearing (35mm x 55mm x 20mm) **B10-1107**

### Shaft Seals

Lip Seal (Black Rubber Coated) Green HNBR **K30-1110**

### Chemicals

Ultra PAG Oil 46 - 6pk, 8 oz Bottle **MT3012**

Ultra PAG Oil 46 - 6pk, Quart Bottle **MT3018**

Ultra PAG Oil 46 - Drum (52 gal) **A10-6163**



*Includes: Lip Seal Retaining Ring (1), Lip Seal Metal Spacer (1), Lip Seal (1)*

### Clutch Components

Clutch Coil - OD/ID: 104.8mm / 65.6mm **H30-7312**

### Fasteners

Bolt - Shaft **F20-2110**

Retaining Ring - Lip Seal **F25-4111**

Retaining Ring - Pulley **F12-4110**

### Tools

Shaft Seal Protector, Adjustable **T95-1228**

### Gaskets

Gasket - Front Head Metal **G30-2140**

Gasket - Rear Head Metal **G30-2141**

Gasket Kit (Metal) Green HNBR **K30-2136**



*Includes: Front Head Gasket - Metal (1), Rear Head Gasket - Metal (1), Pressure Relief Valve O-Ring (1)*

### Piston Components

Piston Ball (13.49mm) (Standard) **P10-1310**

Piston Ball (13.50mm) (Oversize) **P10-1315**

Piston Ball (13.51mm) (Oversize) **P10-1320**

### Service Items

High Pressure Relief Valve 3/8-24 w/Non-Captive O-Ring **A10-5122**

### Shaft Seals

Lip Seal (Black Rubber Coated) HNBR **S30-1110**





## DIESEL KIKI DKS17G (DUAL)

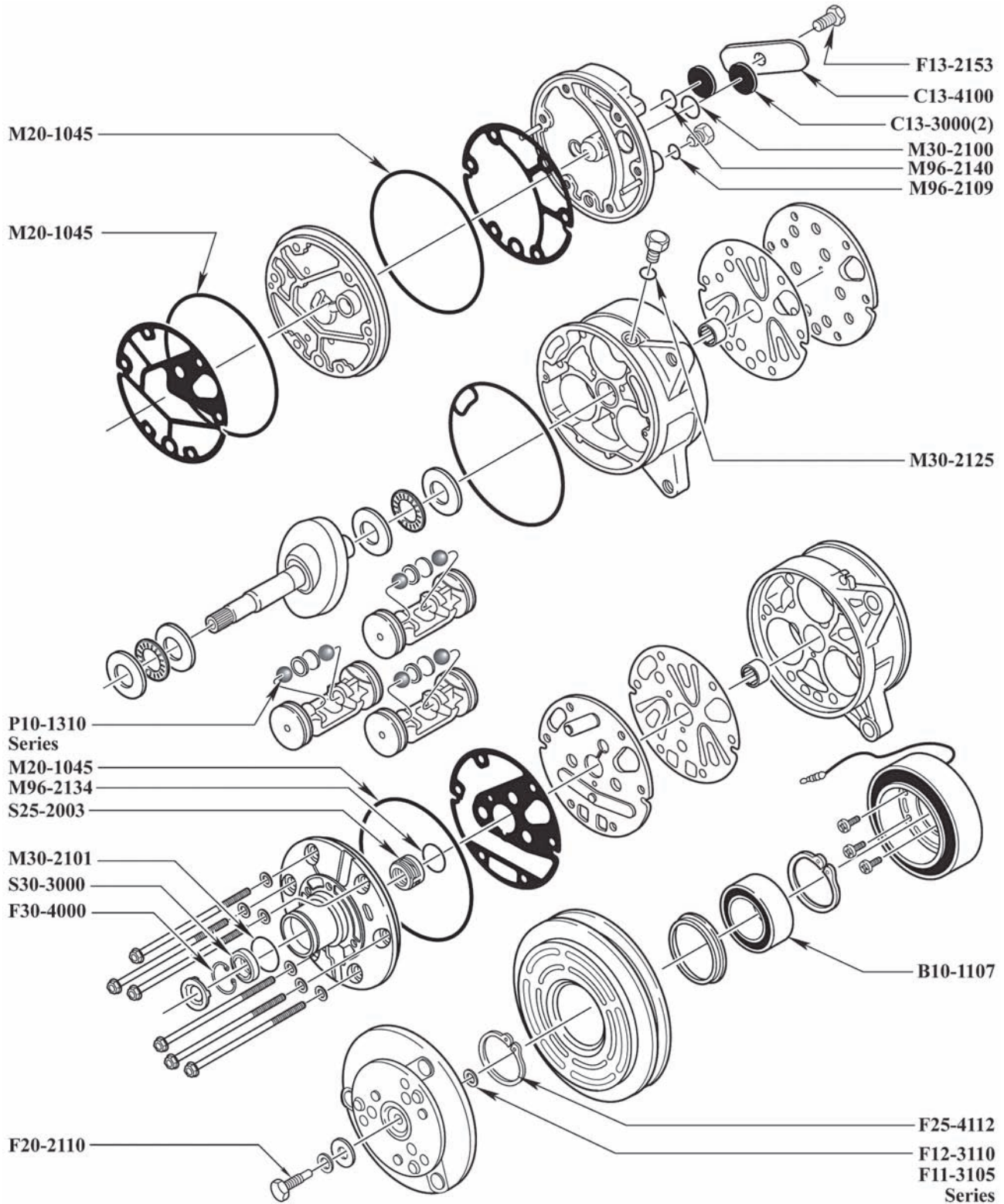



## DIESEL KIKI

### DKS17G (DUAL)

O-Rings	R134a and R-12 Compatible	Green HNBR	Black Nitrile
Carbon Shaft Seal O-Ring		<b>M96-2134</b>	<b>M96-1034</b>
Case O-Ring			<b>M20-1045</b>
Discharge Port O-Ring		<b>M96-2140</b>	<b>M96-1040</b>
Oil Drain Plug O-Ring		<b>M96-2109</b>	<b>M96-1009</b>
Oil Fill Plug O-Ring		<b>M30-2125</b>	
Shaft Seal Seat O-Ring		<b>M30-2101</b>	<b>M30-1001</b>
Suction Port O-Ring		<b>M30-2100</b>	<b>M30-1000</b>
Bearings		Shipping Closures	
Case Bearing (16.3mm x 22mm x 16mm)	<b>B11-2110</b>	Shipping Plate (Rounded) (Use with 2 C13-3000)	<b>C13-4101</b>
Clutch Bearing (35mm x 55mm x 20mm)	<b>B10-1107</b>		
Chemicals		Tools	
Ultra PAG Oil 46 - 6pk, 8 oz Bottle	<b>MT3012</b>	Shaft Seal Protector	<b>T11-1000</b>
Ultra PAG Oil 46 - 6pk, Quart Bottle	<b>MT3018</b>	Shaft Seal Protector, Adjustable	<b>T95-1228</b>
Ultra PAG Oil 46 - Drum (52 gal)	<b>A10-6163</b>		
Fasteners			
Bolt - Shaft	<b>F20-2110</b>		
Bolt - Shipping Plate	<b>F13-2153</b>		
Retaining Ring - Clutch Pulley	<b>F25-4112</b>		
Retaining Ring - Shaft Seal Seat	<b>F30-4000</b>		
Shim - Clutch (0.20mm)	<b>F11-3105</b>		
Shim - Clutch (0.38mm)	<b>F12-3110</b>		
Shim - Clutch (0.51mm)	<b>F11-3115</b>		
Piston Components			
Piston Ball (13.49mm) (Standard)	<b>P10-1310</b>		
Piston Ball (13.50mm) (Oversize)	<b>P10-1315</b>		
Piston Ball (13.51mm) (Oversize)	<b>P10-1320</b>		
Shaft Seals			
Carbon Shaft Seal	Nitrile <b>S25-2003</b>		
Metal Shaft Seal Seat	<b>S30-3000</b>		
Carbon Shaft Seal Kit	Green HNBR <b>K30-3105</b>		



Includes: Shaft Seal Retaining Ring (1), Carbon Shaft Seal (1), Metal Shaft Seal Seat (1), Metal Shaft Seal Seat O-Ring (1)

Shipping Closures	
Shipping Pad (Use with C13-4100 or C13-4101)	<b>C13-3000</b>
Shipping Plate (Rectangular) (Use with 2 C13-3000)	<b>C13-4100</b>

## DIESEL KIKI DKS17G (SINGLE)

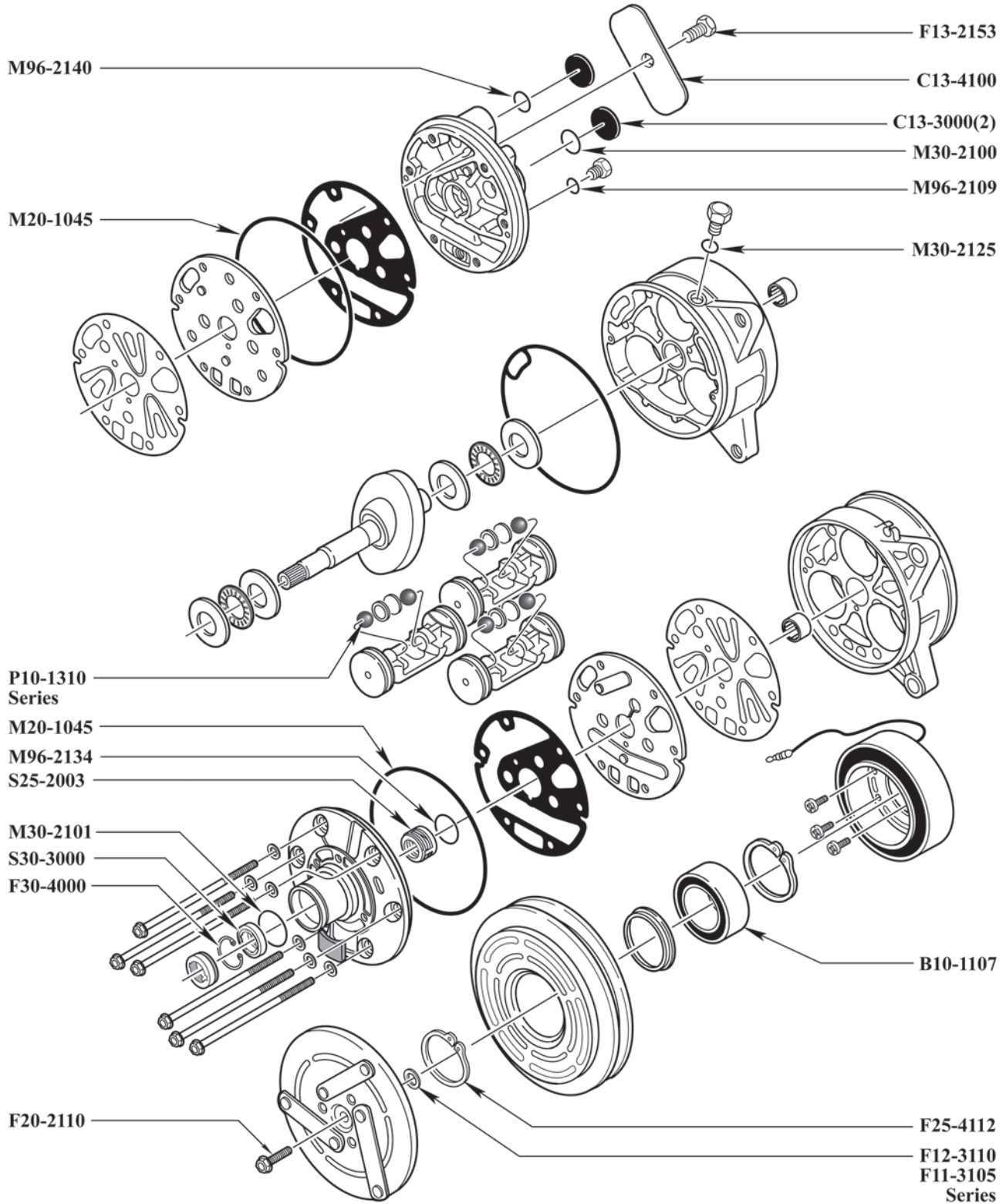

## DIESEL KIKI

### DKS17G (SINGLE)

O-Rings	R134a and R-12 Compatible	Green HNBR	Black Nitrile
Carbon Shaft Seal O-Ring		<b>M96-2134</b>	<b>M96-1034</b>
Case O-Ring			<b>M20-1045</b>
Discharge Port O-Ring		<b>M96-2140</b>	<b>M96-1040</b>
Oil Drain Plug O-Ring		<b>M96-2109</b>	<b>M96-1009</b>
Oil Fill Plug O-Ring		<b>M30-2125</b>	
Shaft Seal Seat O-Ring		<b>M30-2101</b>	<b>M30-1001</b>
Suction Port O-Ring		<b>M30-2100</b>	<b>M30-1000</b>
Bearings		Shipping Closures	
Case Bearing (16.3mm x 22mm x 16mm)	<b>B11-2110</b>	Shipping Plate (Rounded) (Use with 2 C13-3000)	<b>C13-4101</b>
Clutch Bearing (35mm x 55mm x 20mm)	<b>B10-1107</b>		
Chemicals		Tools	
Ultra PAG Oil 46 - 6pk, 8 oz Bottle	<b>MT3012</b>	Shaft Seal Protector	<b>T11-1000</b>
Ultra PAG Oil 46 - 6pk, Quart Bottle	<b>MT3018</b>	Shaft Seal Protector, Adjustable	<b>T95-1228</b>
Ultra PAG Oil 46 - Drum (52 gal)	<b>A10-6163</b>		
Fasteners			
Bolt - Shaft	<b>F20-2110</b>		
Bolt - Shipping Plate	<b>F13-2153</b>		
Retaining Ring - Clutch Pulley	<b>F25-4112</b>		
Retaining Ring - Shaft Seal Seat	<b>F30-4000</b>		
Shim - Clutch (0.20mm)	<b>F11-3105</b>		
Shim - Clutch (0.38mm)	<b>F12-3110</b>		
Shim - Clutch (0.51mm)	<b>F11-3115</b>		
Piston Components			
Piston Ball (13.49mm) (Standard)	<b>P10-1310</b>		
Piston Ball (13.50mm) (Oversize)	<b>P10-1315</b>		
Piston Ball (13.51mm) (Oversize)	<b>P10-1320</b>		
Shaft Seals			
Carbon Shaft Seal	Nitrile <b>S25-2003</b>		
Metal Shaft Seal Seat	<b>S30-3000</b>		
Carbon Shaft Seal Kit	Green HNBR <b>K30-3105</b>		



Includes: Shaft Seal Retaining Ring (1), Carbon Shaft Seal (1), Metal Shaft Seal Seat (1), Metal Shaft Seal Seat O-Ring (1)

Shipping Closures	
Shipping Pad (Use with C13-4100 or C13-4101)	<b>C13-3000</b>
Shipping Plate (Rectangular) (Use with 2 C13-3000)	<b>C13-4100</b>

## DIESEL KIKI DKS17S

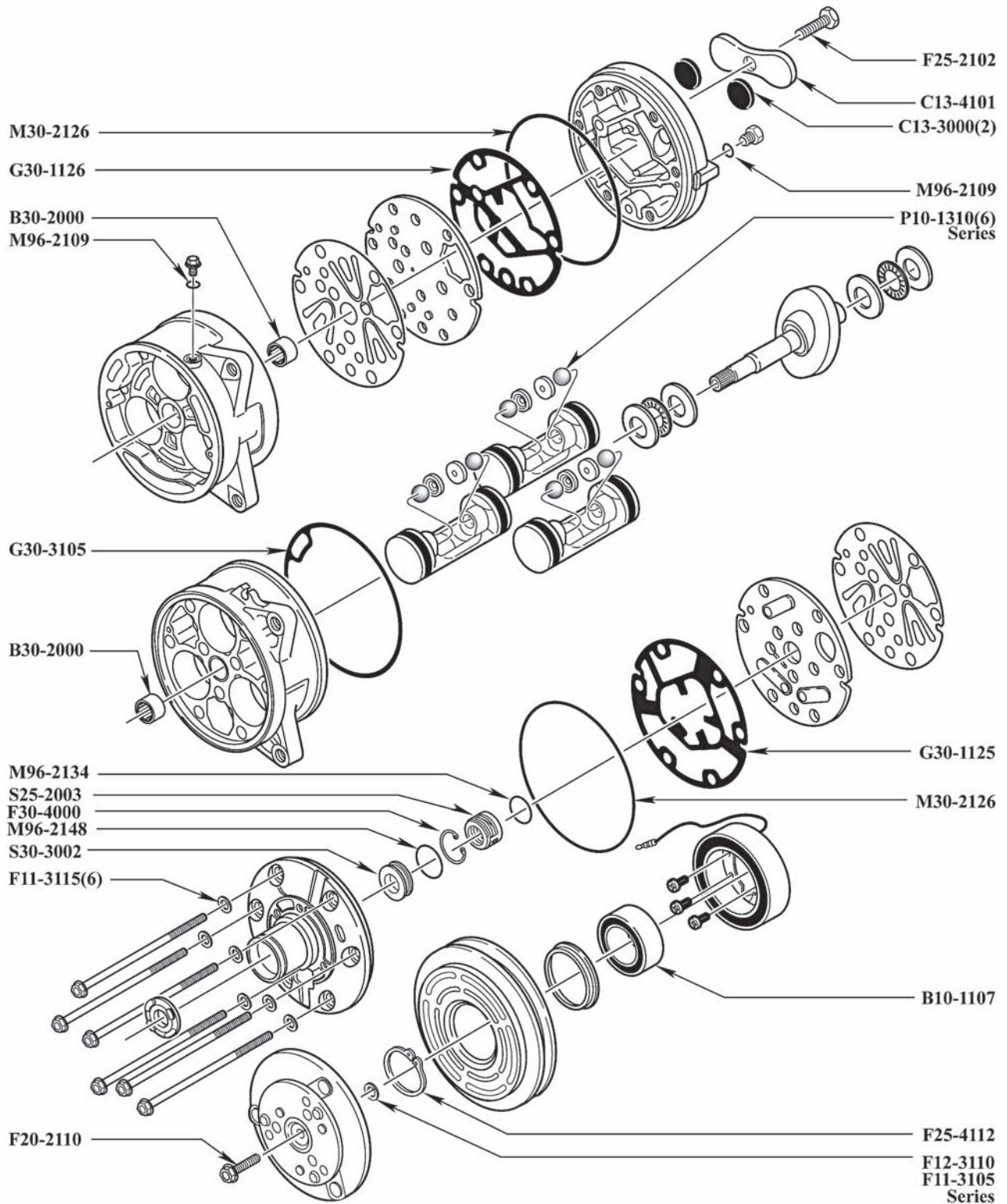

## DIESEL KIKI

### DKS17S

O-Rings	R134a and R-12 Compatible	Green HNBR	Black Nitrile
Carbon Shaft Seal O-Ring		<b>M96-2134</b>	<b>M96-1034</b>
Case O-Ring (Front and Rear)		<b>M30-2126</b>	
Oil Drain Plug O-Ring		<b>M96-2109</b>	<b>M96-1009</b>
Shaft Seal Seat O-Ring		<b>M96-2148</b>	<b>M96-1048</b>

#### Bearings

Case Bearing (16mm x 22mm x 20mm)	<b>B30-2000</b>
Clutch Bearing (35mm x 55mm x 20mm)	<b>B10-1107</b>

#### Chemicals

Ultra PAG Oil 100 - 6pk, 8 oz Bottle	<b>MT3013</b>
Ultra PAG Oil 100 - 6pk, Quart Bottle	<b>MT3019</b>
Ultra PAG Oil 100 - Drum (52 gal)	<b>A10-6164</b>

#### Fasteners

Bolt - Shaft	<b>F20-2110</b>
Bolt - Shipping Plate	<b>F25-2102</b>
Retaining Ring - Clutch Pulley	<b>F25-4112</b>
Retaining Ring - Shaft Seal Seat	<b>F30-4000</b>
Shim - Clutch (0.20mm)	<b>F11-3105</b>
Shim - Clutch (0.38mm)	<b>F12-3110</b>
Shim - Clutch (0.51mm)/Head Bolt Washer	<b>F11-3115</b>

#### Gaskets

Gasket - Front Head	Fiber <b>G30-1125</b>
Gasket - Rear Head	Fiber <b>G30-1126</b>
Gasket - Center Case	Green HNBR <b>G30-3105</b>
Gasket Kit (Fiber)	Green HNBR <b>K30-2125</b>

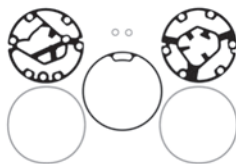

Includes: Front Head Gasket (1), Rear Head Gasket(1), Center Case Gasket (1), Case O-Ring (2), Oil Plug O-Ring (2).

#### Piston Components

Piston Ball (13.49mm) (Standard)	<b>P10-1310</b>
Piston Ball (13.50mm) (Oversize)	<b>P10-1315</b>
Piston Ball (13.51mm) (Oversize)	<b>P10-1320</b>

#### Shaft Seals

Carbon Shaft Seal	Nitrile <b>S25-2003</b>
Metal Shaft Seal Seat	<b>S30-3002</b>

#### Shaft Seals

Carbon Shaft Seal Kit Green HNBR **K30-3107**



Includes: Shaft Seal Retaining Ring (1), Carbon Shaft Seal (1), Metal Shaft Seal Seat (1), Metal Shaft Seal Seat O-Ring (1)

#### Shipping Closures

Shipping Pad (Use with C13-4101)	<b>C13-3000</b>
Shipping Plate (Rounded) (Use with 2 C13-3000)	<b>C13-4101</b>

#### Tools

Clutch Puller (3 Screw)	<b>T25-1000</b>
Shaft Seal Protector	<b>T11-1000</b>
Shaft Seal Protector, Adjustable	<b>T95-1228</b>

## DIESEL KIKI DKV11G, DKV14G

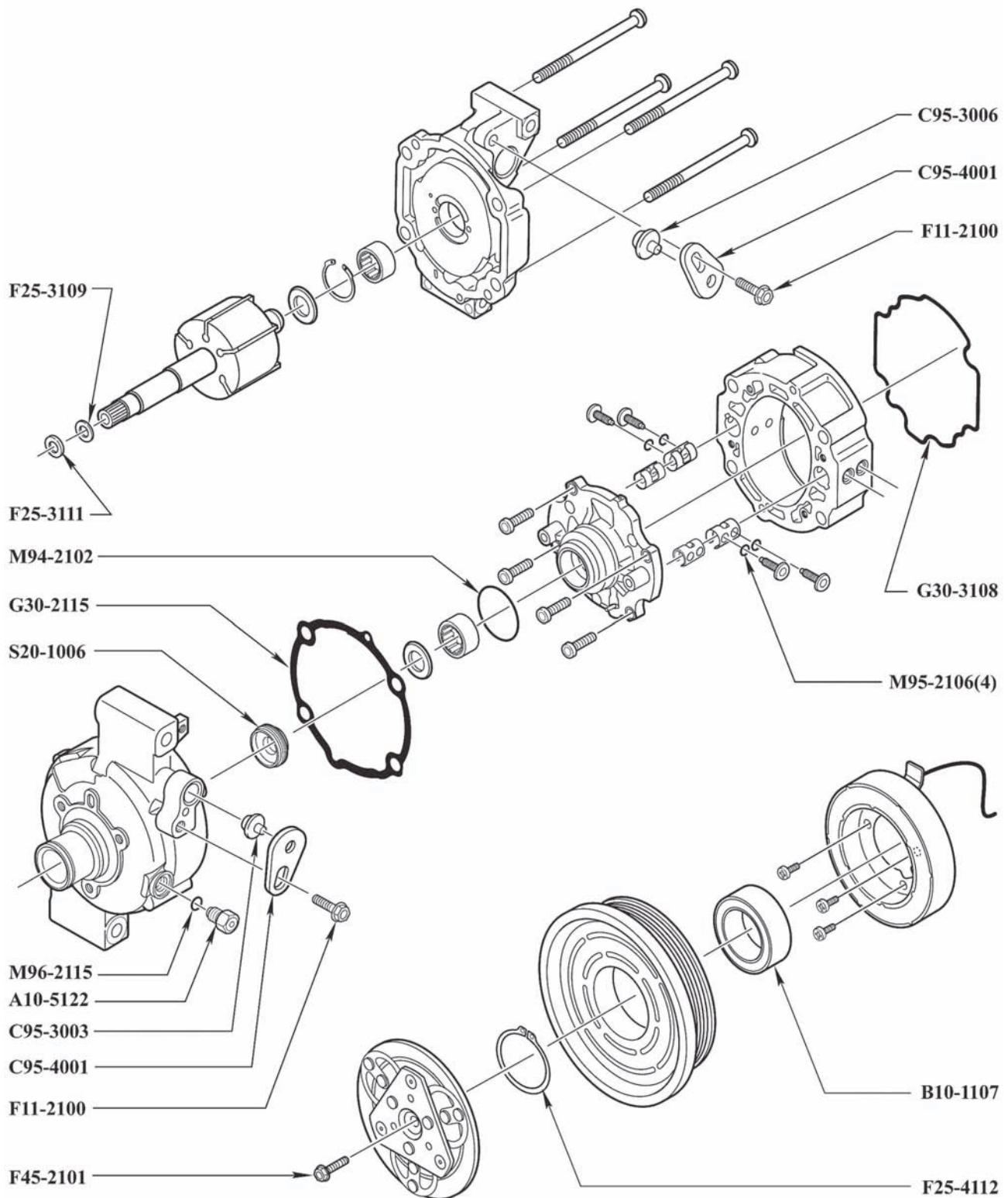

## DIESEL KIKI

DKV11G, DKV14G

O-Rings	R134a and R-12 Compatible	Green HNBR	Black Nitrile
Discharge Reed Bolt O-Ring		<b>M95-2106</b>	<b>M95-1006</b>
Internal Front Housing to Nose O-Ring		<b>M94-2102</b>	<b>M94-1002</b>
Pressure Relief Valve O-Ring		<b>M96-2115</b>	<b>M96-1015</b>

### Bearings

Clutch Bearing (35mm x 55mm x 20mm) **B10-1107**

### Chemicals

Ultra PAG Oil 100 - 6pk, 8 oz Bottle **MT3013**

Ultra PAG Oil 100 - 6pk, Quart Bottle **MT3019**

Ultra PAG Oil 100 - Drum (52 gal) **A10-6164**

### Fasteners

Bolt - Shaft **F45-2101**

Bolt - Shipping Plate **F11-2100**

Helical Insert - Rear Head / Shipping Plate (8-1.25 x 12mm) **F10-6211**

Retaining Ring - Pulley **F25-4112**

Shim - Clutch (0.38mm) **F25-3111**

Shim - Clutch (0.76mm) **F25-3109**

### Gaskets

Gasket - Metal - Rear Metal **G30-2115**

Gasket - Rotor Body - Rear Green HNBR **G30-3108**

Gasket Kit (Metal) **K30-5003**

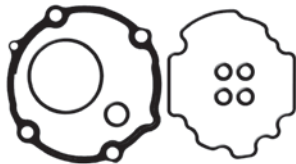

*Includes: Front Head Gasket (1), Rotor Rear Gasket (1), Discharge Reed Bolt O-Ring (4), PRV O-Ring (1), Rotor Nose O-Ring*

### Service Items

High Pressure Relief Valve 3/8-24 w/Non-Captive O-Ring **A10-5122**

### Shaft Seals

Lip Seal (Black Rubber Coated) HNBR **S20-1006**

### Shipping Closures

Shipping Plate (Use with C95-3003 & C95-3006) **C95-4001**

Shipping Plug (Discharge) (Use with C95-4001) **C95-3003**

Shipping Plug (Suction) (Use with C95-4001) **C95-3006**

### Tools

Helical Insert Drill for 8-1.25mm Inserts **T10-6053**

Helical Insert Tap 8-1.25mm **T10-6254**

### Tools

Helical Insert Tool 8-1.25mm - Bolt Style **T10-6554**

Shaft Seal Protector, Adjustable **T95-1228**

Helical Insert Repair Kit (8-1.25mm) **K10-1180**



*Includes: Helical Inserts (25), Drill (1), Tap (1), Installation Tool - Bolt Style (1)*

**FORD**

**F500**



## FORD

### F500

O-Rings	R134a and R-12 Compatible	Green HNBR	Black Nitrile
Control Valve Inner O-Ring		M96-2171	
Control Valve Middle O-Ring		M96-2155	
Control Valve Outer O-Ring		M11-2111	
High Pressure Relief Valve O-Ring		M96-2118	M96-1018
<b>Bearings</b>			
Case Bearing (14.3mm x 20.6mm x 15.7mm)	B13-2133		
Clutch Bearing (35mm x 52mm x 20mm)	B20-1109		
<b>Chemicals</b>			
Ultra PAG Oil 46 - 6pk, 8 oz Bottle	MT3012		
Ultra PAG Oil 46 - 6pk, Quart Bottle	MT3018		
Ultra PAG Oil 46 - Drum (52 gal)	A10-6163		
<b>Fasteners</b>			
Retaining Ring - Clutch Coil (Beveled)	F13-4125		
Retaining Ring - Clutch Pulley	F25-4112		
Retaining Ring - Control Valve / Case Thrust Bearing Spring	F30-4000		
Retaining Ring - Lip Seal	F13-4115		
<b>Service Items</b>			
High Pressure Relief Valve 3/8-24 w/Non-Captive O-Ring	A10-5122		
<b>Shaft Seals</b>			
Felt Wiper - Wick Type	S13-4101		
Lip Seal (Black Rubber Coated)	Nitrile S12-1005		
Lip Seal (Black Rubber Coated) (O.E.)	Nitrile S12-1006		

## FORD

### FS6, FS6 CROSS MOUNT

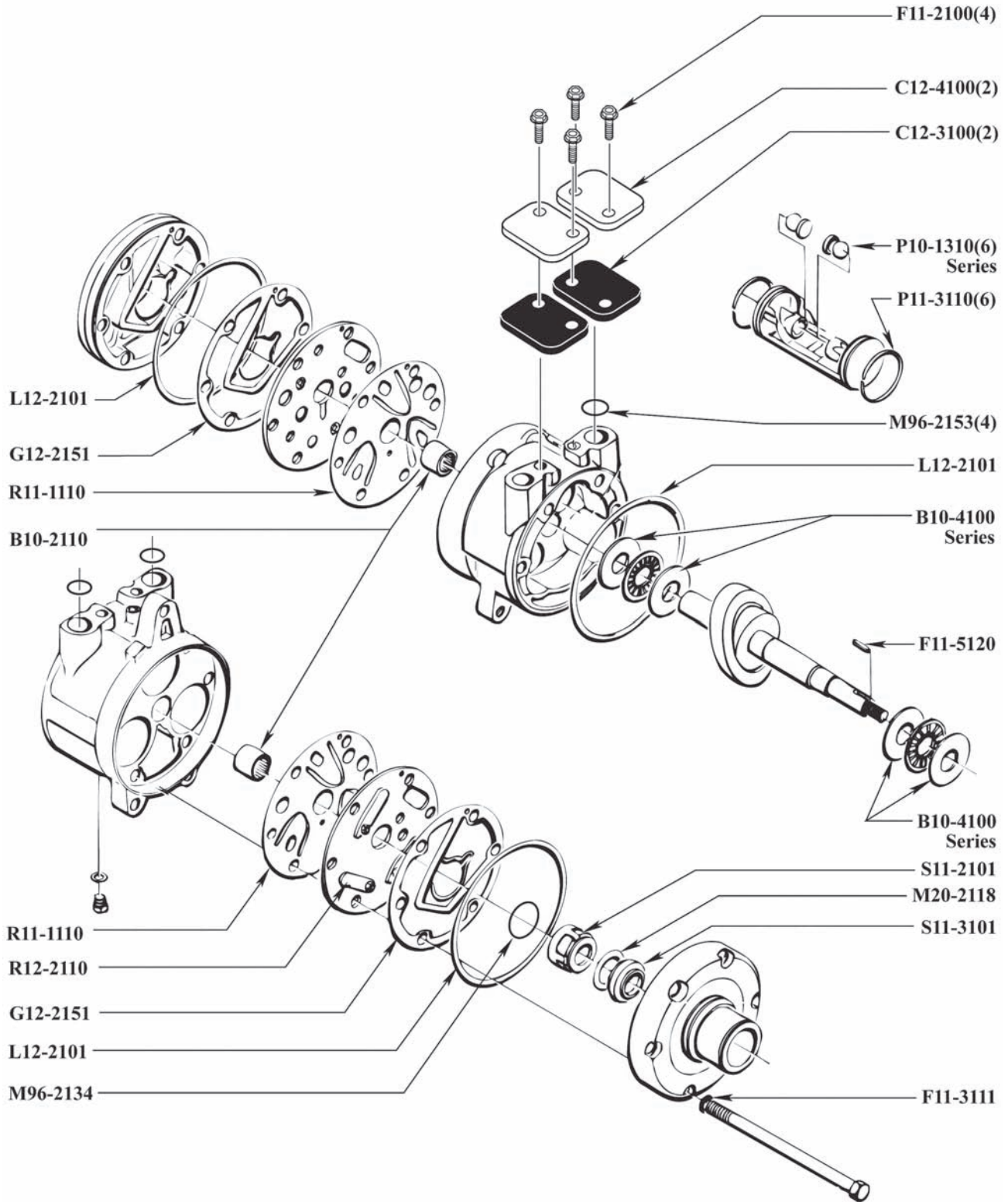

## FORD

### FS6, FS6 CROSS MOUNT

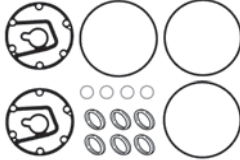
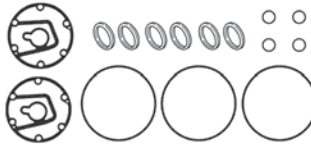
O-Rings and Lathe Cuts	R134a and R-12 Compatible	Green HNBR	Black Nitrile
Carbon Shaft Seal O-Ring		<b>M96-2134</b>	<b>M96-1034</b>
Case Lathe Cut Seal		<b>L12-2101</b>	
Shaft Seal Seat O-Ring		<b>M11-2102</b>	<b>M11-1002</b>
Shaft Seal Seat O-Ring (Use on S11-3101 only)		<b>M20-2118</b>	<b>M20-1018</b>
Suction / Discharge Port O-Ring		<b>M96-2153</b>	<b>M96-1053</b>
Suction / Discharge Port O-Ring (Aftermarket Hose Assembly)		<b>M11-2105</b>	<b>M11-1005</b>
Suction / Discharge Port Oval O-Ring (X-Mount/Tangent only)		<b>A12-1110</b>	
Bearings		Fasteners	
Case Bearing (16.3mm x 22mm x 16mm) (1983 and Later)	<b>B11-2110</b>	Clutch Installation Kit	<b>K20-5110</b>
Case Bearing (16mm x 23mm x 21.9mm) (Pre 1983)	<b>B10-2110</b>	 <p><i>Includes: Coil Retaining Ring (0.078" - 1.198 mm Thick) (1), Coil Retaining Ring - (0.062 - 1.57 mm Thick) (1), Pulley Retaining Ring (1), Shaft Locknut (1), Shaft Lockwasher (1), Hub Shim - .020" Thick (5), Shaft Key (Long) (1), Shaft Key (Short) (1)</i></p>	
Clutch Bearing (40mm x 62mm x 20.6mm-24mm)	<b>B10-1110</b>		
Thrust Race (2.70mm)	<b>B10-4101</b>		
Thrust Race (2.71mm)	<b>B10-4102</b>		
Thrust Race (2.77mm)	<b>B10-4109</b>		
Chemicals		Gaskets	
Ultra PAG Oil 46 - 6pk, 8 oz Bottle	<b>MT3012</b>	Gasket - Head	Metal <b>G12-2151</b>
Ultra PAG Oil 46 - 6pk, Quart Bottle	<b>MT3018</b>	Gasket Kit (Metal)	Green HNBR <b>K12-2105</b>
Ultra PAG Oil 46 - Drum (52 gal)	<b>A10-6163</b>	 <p><i>Includes: Head Bolt Washer (6), Head Gasket (Metal) (2), Case Lathe Cut Seal (3), Suction / Discharge Port O-Ring (4)</i></p>	
Electrical			
Clutch Coil Pigtail	<b>E12-4000</b>	Gasket Kit (Metal)	Black Nitrile <b>K12-2005</b>
Fasteners		 <p><i>Includes: Head Bolt Washer (6), Head Gasket (Metal) (2), Case Lathe Cut Seal (3), Suction / Discharge Port O-Ring (4)</i></p>	
Bolt - Shipping Closure (Use with C12-5101)	<b>F11-2100</b>		
Helical Insert - Rear Head / Shipping Plate (8-1.25 x 12mm)	<b>F10-6211</b>	Piston Components	
Nut - Shaft	<b>F11-1110</b>	Piston Ball (13.49mm) (Standard)	<b>P10-1310</b>
Shaft Key (Short - 11.9mm x 4.0mm)	<b>F11-5120</b>	Piston Ball (13.50mm) (Oversize)	<b>P10-1315</b>
Retaining Ring - Coil (1.57mm)	<b>F11-4120</b>	Piston Ball (13.51mm) (Oversize)	<b>P10-1320</b>
Retaining Ring - Coil (1.98mm)	<b>F10-4120</b>	Piston Ring (1.91mm) (Standard)	<b>P11-3110</b>
Retaining Ring - Pulley	<b>F10-4130</b>	Reeds and Valve Plates	
Retaining Ring - Shaft Seal Seat	<b>F20-4110</b>	Reed - Discharge Valve	<b>R12-2110</b>
Lockwasher - Shaft	<b>F11-3110</b>		
Shim - Clutch (0.20mm)	<b>F11-3105</b>		
Shim - Clutch (0.51mm)	<b>F11-3115</b>		
Washer - Head Bolt	<b>F11-3111</b>		

## FORD

### FS6, FS6 CROSS MOUNT

#### Reeds and Valve Plates

Reed - Suction Valve **R11-1110**

#### Service Items

Fitting (Refrigerant) - 1/8" NPT Brass Port w/ Valve **A10-1024**

#### Shaft Seals

Carbon Shaft Seal **HNBR S11-2101**

Felt Wiper **S11-6101**

Felt Wiper - Wick Type **S13-4101**

Metal Shaft Seal Seat **S11-3101**

Carbon Shaft Seal Kit **Green HNBR K20-3115**



*Includes: Head Bolt Washer (6), Lip Seal/Metal Shaft Seal Retaining Ring (1), Lip Seal/Metal Shaft Seal Seat O-Ring (Pre-92) (1), Carbon Shaft Seal (Pre-92) (1), Metal Shaft Seal Seat (1)*

FS6 Carbon Shaft Seal Kit **Green HNBR K12-3105**  
with Gaskets - HNBR

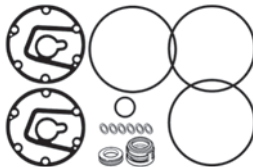

*Includes: Head Bolt Washer (6), Valve Plate Gasket - Metal (2), Shaft Seal Seat O-ring (1), Case O-Ring (3), Carbon Seal (1), Metal Seal Seat (1)*

#### Shipping Closures

Cap - 1/4" Low Side **C10-1000**

Shipping Plug **C12-1100**

Shipping Pad (Use with C12-4100 or C12-4101) **C12-3100**

Shipping Pad (Use with C12-4102) **C13-3000**

Shipping Plate (Use with 2 C12-3100) (Covers all 4 ports) **C12-4101**

Shipping Plate (Use with 2 C13-3000) **C12-4102**

Shipping Plate (Use with C12-3100) **C12-4100**

#### Tools

Clutch Plate Remover **T13-3042**

Clutch Puller **T11-1001**

Helical Insert Drill for 8-1.25mm Inserts **T10-6053**

Helical Insert Tap 8-1.25mm **T10-6254**

#### Tools

Helical Insert Tool 8-1.25mm - Bolt Style **T10-6554**

Shaft Seal Installer / Remover (Aftermarket) **T20-3002**

Shaft Seal Protector **T11-1000**

Shaft Seal Protector, Adjustable **T95-1228**

Helical Insert Repair Kit (8-1.25mm) **K10-1180**



*Includes: Helical Inserts (25), Drill (1), Tap (1), Installation Tool - Bolt Style (1)*



## FORD FS10

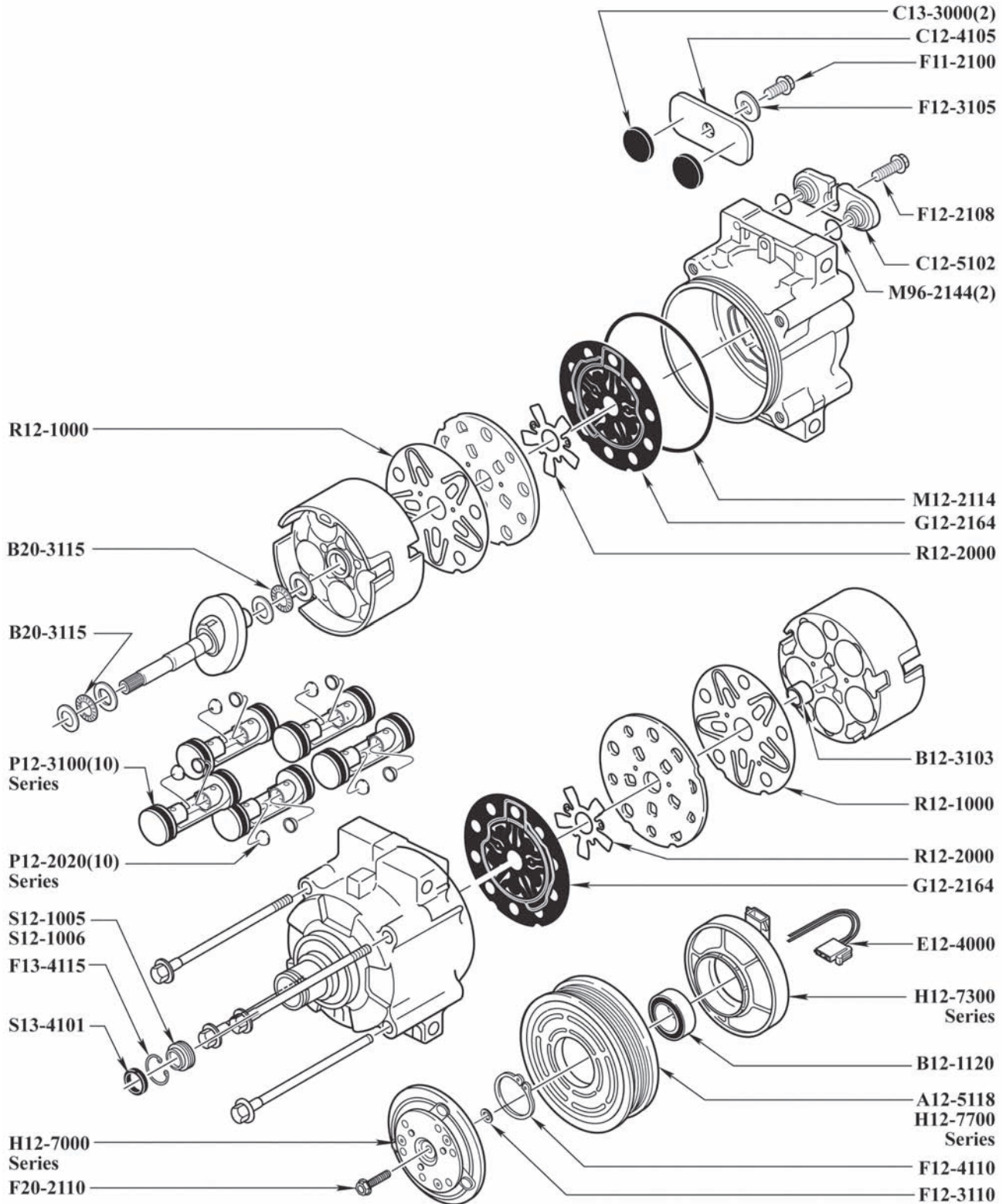

## FORD

### FS10

O-Rings	R134a and R-12 Compatible	Green HNBR	Black Nitrile
Case O-Ring		<b>M12-2114</b>	<b>M12-1014</b>
Suction / Discharge Port O-Ring		<b>M96-2144</b>	<b>M96-1044</b>
<b>Bearings</b>		<b>Electrical</b>	
Clutch Bearing (30mm x 55mm x 23mm)	<b>B12-1120</b>	Clutch Coil Pigtail	<b>E12-4000</b>
Shaft Bushing (16.1mm x 18.1mm x 20mm)	<b>B12-3103</b>	<b>Fasteners</b>	
Thrust Bearing (17.3mm x 34mm x 3mm)	<b>B20-3115</b>	Bolt - Shaft	<b>F20-2110</b>
<b>Chemicals</b>		Bolt - Shipping Plate (Use w/ C12-4105)	<b>F11-2100</b>
Ultra PAG Oil 46 - 6pk, 8 oz Bottle	<b>MT3012</b>	Bolt - Shipping Plate (Use w/ C12-5102)	<b>F12-2108</b>
Ultra PAG Oil 46 - 6pk, Quart Bottle	<b>MT3018</b>	Helical Insert - Rear Head / Shipping Plate (8-1.25 x 12mm)	<b>F10-6211</b>
Ultra PAG Oil 46 - Drum (52 gal)	<b>A10-6163</b>	Retaining Ring - Lip Seal	<b>F13-4115</b>
<b>Clutch Components</b>		Retaining Ring - Pulley	<b>F12-4110</b>
Clutch Assembly - 6 Groove	<b>H12-7905</b>	Mounting Bushing (Long - 15mm)	<b>F12-3102</b>
Clutch Assembly - 6 Groove	<b>H12-7906</b>	Mounting Bushing (Short - 10mm)	<b>F12-3101</b>
Clutch Assembly - 6 Groove (113mm)	<b>H12-7904</b>	Shim - Clutch (0.38mm)	<b>F12-3110</b>
Clutch Assembly - 6 Groove (129.5mm)	<b>H12-7902</b>	Washer - Shipping Plate (Use with C12-4105)	<b>F12-3105</b>
Rubber Bumper on Drive Hub Face	<b>A12-5113</b>	Clutch Installation Kit	<b>K12-5110</b>
Clutch Coil - OD/ID: 101mm / 66mm	<b>H12-7301</b>	 <p><i>Includes: Clutch Shim (0.015" - 0.38mm Thick) (6), Pulley Retaining Ring (1), Shaft Bolt (1)</i></p>	
Clutch Coil - OD/ID: 101mm / 66mm (Hyundai)	<b>H12-7303</b>		
Clutch Coil - OD/ID: 101mm / 66mm (Kia)	<b>H12-7304</b>		
Clutch Coil - OD/ID: 115mm / 63.5mm	<b>H12-7306</b>		
Clutch Coil - OD/ID: 95.6mm / 63.45mm	<b>H12-7302</b>		
Clutch Coil - OD/ID: 96.3mm / 61.2mm (Chrysler)	<b>H12-7307</b>		
Clutch Hub - 21 Spline (110mm dia) (Leaf Spring)	<b>H12-7005</b>		
Clutch Hub - 21 Spline (111.5 mm dia) (Rubber Bumper)	<b>H12-7004</b>		
Clutch Hub - 21 Spline (115mm dia) (Leaf Spring)	<b>H12-7006</b>		
Clutch Hub - 21 Spline (Shaft Length 17mm) (Leaf Spring)	<b>H12-7001</b>		
Clutch Hub - 21 Spline (Shaft Length 23mm) (Leaf Spring)	<b>H12-7000</b>	<b>Mounting Bushing Kit</b> <b>K12-5104</b>	
Clutch Hub - 21 Spline (Shaft Length 23mm) (Rubber Bumper)	<b>H12-7002</b>	 <p><i>Includes: Mounting Bushing (Long - 0.595" - 15 mm Long) (8)</i></p>	
Clutch Pulley - 4 Groove (128mm x 32.7mm)	<b>H12-7717</b>		
Clutch Pulley - 6 Groove (129mm x 30.8mm)	<b>H12-7700</b>	<b>Mounting Shim Kit</b> <b>K12-5105</b>	
Clutch Pulley - 6 Groove (132.5mm x 43mm)	<b>H12-7714</b>	 <p><i>Includes: Mounting Bushing (Short - 0.395" - 10 mm Long) (2), Mounting Bushing (Long - 0.595" - 15 mm Long) (2), Clutch Shim (0.015" - 0.38mm Thick) (6), Pulley Retaining Ring (1), Shaft Bolt (1)</i></p>	
Clutch Pulley - 7 Groove (131.6mm x 35.5mm)	<b>H12-7709</b>		
Clutch Pulley - 8 Groove (131.5mm x 36mm)	<b>H12-7703</b>		
Pulley - 6 Groove w/Bearing	<b>A12-5118</b>	<b>Gaskets</b>	
		Gasket - Head	<b>Metal G12-2164</b>

## FORD

### FS10

#### Gaskets

Gasket Kit (Metal)

Green HNBR **K12-2125**



Includes: Head Gasket (Mid) (2), Case O-Ring (1), Suction / Discharge Port O-Ring (2)

#### Piston Components

Half Ball Shoe (7.490 - 7.495mm)	<b>P12-2020</b>
Half Ball Shoe (7.495 - 7.500mm)	<b>P12-2021</b>
Half Ball Shoe (7.500 - 7.505mm)	<b>P12-2022</b>
Half Ball Shoe (7.505 - 7.510mm)	<b>P12-2023</b>
Half Ball Shoe (7.510 - 7.515mm)	<b>P12-2024</b>
Half Ball Shoe (7.515 - 7.520mm)	<b>P12-2025</b>
Half Ball Shoe (7.520 - 7.525mm)	<b>P12-2026</b>
Half Ball Shoe (7.525 - 7.530mm)	<b>P12-2027</b>
Half Ball Shoe (7.530 - 7.535mm)	<b>P12-2028</b>
Half Ball Shoe (7.535 - 7.540mm)	<b>P12-2029</b>
Piston Ring (0.813mm) (Standard)	<b>P12-3100</b>
Piston Ring (1.12mm) (Oversize)	<b>P12-3101</b>

#### Reeds and Valve Plates

Reed - Discharge Valve	<b>R12-2000</b>
Reed - Suction Valve	<b>R12-1000</b>

#### Shaft Seals

Felt Wiper - Wick Type	<b>S13-4101</b>
Lip Seal (Black Rubber Coated)	Nitrile <b>S12-1005</b>
Lip Seal (Black Rubber Coated) (O.E.)	Nitrile <b>S12-1006</b>

Lip Seal Kit **Black Nitrile K12-3011**

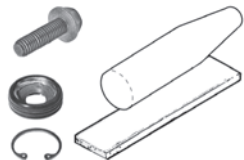

Includes: Lip Seal Retaining Ring (1), Shaft Bolt (1), Lip Seal (1), Felt Wiper (1), Lip Seal Protector (Plastic-16 Spline) (1).

#### Shipping Closures

Shipping Closure (Use with F12-2108, Bolt, 30mm)	<b>C12-5102</b>
Shipping Pad (Use with C12-4105)	<b>C13-3000</b>

#### Shipping Closures

Shipping Plate (Use 2 C13-3000, F11-2100 & F12-3105) **C12-4105**

#### Tools

Helical Insert Drill for 8-1.25mm Inserts	<b>T10-6053</b>
Helical Insert Tap 8-1.25mm	<b>T10-6254</b>
Helical Insert Tool 8-1.25mm - Bolt Style	<b>T10-6554</b>
Lip Seal Protector (21 Spline) (Plastic)	<b>T12-1002</b>
Piston Ring Expansion Cone (Requires T13-3010)	<b>T12-3000</b>
Piston Ring Installer	<b>T13-3010</b>
Shaft Seal Protector (21 Spline)	<b>T95-1396</b>
Shaft Seal Protector, Adjustable	<b>T95-1227</b>
Shaft Seal Protector, Adjustable	<b>T95-1230</b>
Helical Insert Repair Kit (8-1.25mm)	<b>K10-1180</b>



Includes: Helical Inserts (25), Drill (1), Tap (1), Installation Tool - Bolt Style (1)





## FORD

### FS18

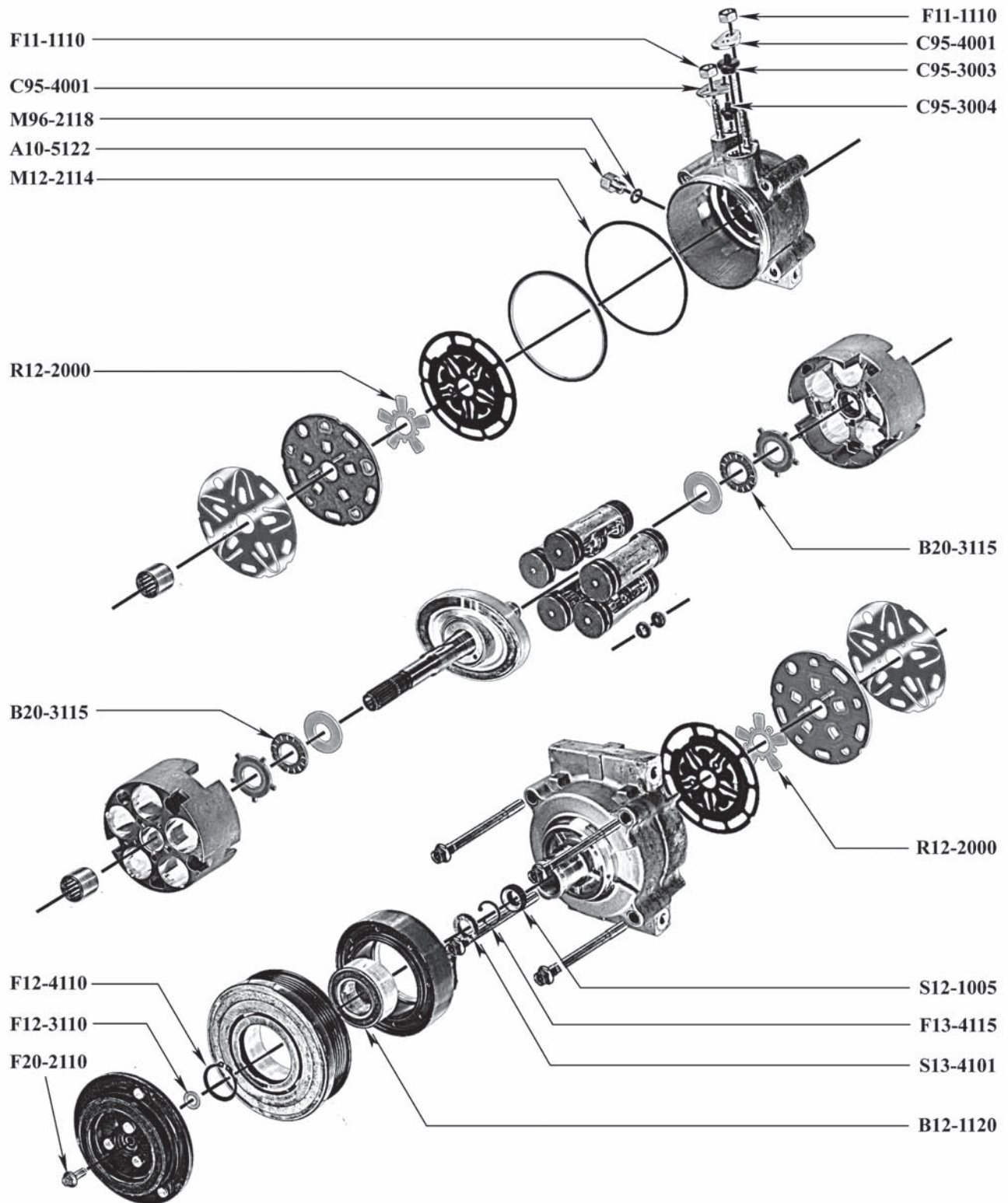

## FORD

### FS18

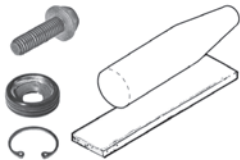
O-Rings	R134a and R-12 Compatible	Green HNBR	Black Nitrile
Case O-Ring		<b>M12-2114</b>	<b>M12-1014</b>
High Pressure Relief Valve O-Ring		<b>M96-2118</b>	<b>M96-1018</b>
<b>Bearings</b>		<b>Shaft Seals</b>	
Clutch Bearing (30mm x 55mm x 23mm)	<b>B12-1120</b>	Felt Wiper - Wick Type	<b>S13-4101</b>
Thrust Bearing (17.3mm x 34mm x 3mm)	<b>B20-3115</b>	Lip Seal (Black Rubber Coated)	Nitrile <b>S12-1005</b>
<b>Fasteners</b>		Lip Seal (Black Rubber Coated) (O.E.)	Nitrile <b>S12-1006</b>
Bolt - Shaft	<b>F20-2110</b>	Lip Seal Kit	Black Nitrile <b>K12-3011</b>
Nut - Shipping Plate	<b>F11-1110</b>	 <p><i>Includes: Lip Seal Retaining Ring (1), Shaft Bolt (1), Lip Seal (1), Felt Wiper (1), Lip Seal Protector (Plastic-16 Spline) (1).</i></p>	
Retaining Ring - Lip Seal	<b>F13-4115</b>		
Retaining Ring - Pulley	<b>F12-4110</b>		
Mounting Bushing (Long - 15mm)	<b>F12-3102</b>		
Mounting Bushing (Short - 10mm)	<b>F12-3101</b>		
Shim - Clutch (0.38mm)	<b>F12-3110</b>		
Clutch Installation Kit	<b>K12-5110</b>		
 <p><i>Includes: Clutch Shim (0.015" - 0.38mm Thick) (6), Pulley Retaining Ring (1), Shaft Bolt (1)</i></p>			
<b>Shipping Closures</b>			
Shipping Plate (Use with C95-3003 & C95-3004)			
Shipping Plug (Discharge) (Use with C95-4001)		<b>C95-3003</b>	
Shipping Plug (Suction) (Use with C95-4001)		<b>C95-3004</b>	
<b>Tools</b>			
Helical Insert Drill for 8-1.25mm Inserts		<b>T10-6053</b>	
Helical Insert Tap 8-1.25mm		<b>T10-6254</b>	
Helical Insert Tool 8-1.25mm - Bolt Style		<b>T10-6554</b>	
Lip Seal Protector (21 Spline) (Plastic)		<b>T12-1002</b>	
Shaft Seal Protector (21 Spline)		<b>T95-1396</b>	
Shaft Seal Protector, Adjustable		<b>T95-1227</b>	
Helical Insert Repair Kit (8-1.25mm)		<b>K10-1180</b>	
 <p><i>Includes: Helical Inserts (25), Drill (1), Tap (1), Installation Tool - Bolt Style (1)</i></p>			
<b>Reeds and Valve Plates</b>			
Reed - Discharge Valve	<b>R12-2000</b>		
<b>Service Items</b>			
High Pressure Relief Valve 3/8-24 w/Non-Captive O-Ring	<b>A10-5122</b>		





## FORD FX15

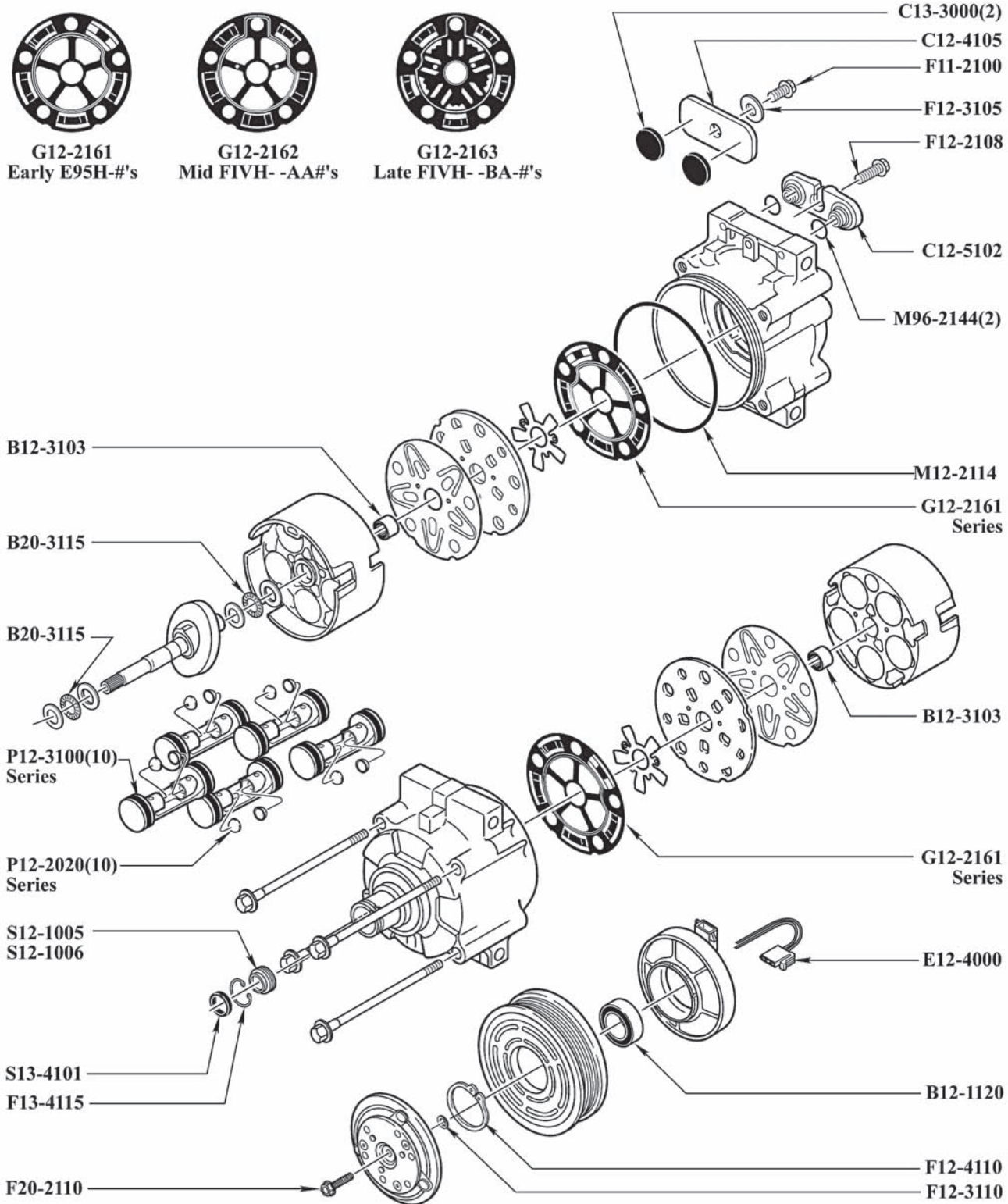

## FORD

### FX15

O-Rings	R134a and R-12 Compatible	Green HNBR	Black Nitrile
Case O-Ring		<b>M12-2114</b>	<b>M12-1014</b>
Suction / Discharge Port O-Ring		<b>M96-2144</b>	<b>M96-1044</b>

Bearings	
Clutch Bearing (30mm x 55mm x 23mm)	<b>B12-1120</b>
Shaft Bushing (16.1mm x 18.1mm x 20mm)	<b>B12-3103</b>
Thrust Bearing (17.3mm x 34mm x 3mm)	<b>B20-3115</b>

Chemicals	
Ultra PAG Oil 46 - 6pk, 8 oz Bottle	<b>MT3012</b>
Ultra PAG Oil 46 - 6pk, Quart Bottle	<b>MT3018</b>
Ultra PAG Oil 46 - Drum (52 gal)	<b>A10-6163</b>

Clutch Components	
Clutch Assembly - 6 Groove (129.5mm)	<b>H12-7902</b>
Clutch Assembly - 8 Groove (131.3mm) (97-92 F-Series Diesel)	<b>H12-7901</b>

Electrical	
Clutch Coil Pigtail	<b>E12-4000</b>

Fasteners	
Bolt - Shaft	<b>F20-2110</b>
Bolt - Shipping Plate (Use w/ C12-4105)	<b>F11-2100</b>
Bolt - Shipping Plate (Use w/ C12-5102)	<b>F12-2108</b>
Helical Insert - Rear Head / Shipping Plate (8-1.25 x 12mm)	<b>F10-6211</b>
Retaining Ring - Lip Seal	<b>F13-4115</b>
Retaining Ring - Pulley	<b>F12-4110</b>
Mounting Bushing (Long - 15mm)	<b>F12-3102</b>
Mounting Bushing (Short - 10mm)	<b>F12-3101</b>
Shim - Clutch (0.38mm)	<b>F12-3110</b>
Washer - Shipping Plate (Use with C12-4105)	<b>F12-3105</b>
Clutch Installation Kit	<b>K12-5110</b>



Includes: Clutch Shim (0.015" - 0.38mm Thick) (6), Pulley Retaining Ring (1), Shaft Bolt (1)

Fasteners	
Mounting Bushing Kit	<b>K12-5104</b>

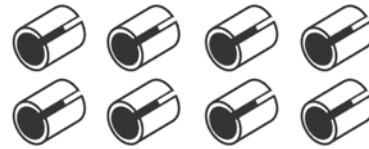

Includes: Mounting Bushing (Long - 0.595" - 15 mm Long) (8)

Mounting Shim Kit	
	<b>K12-5105</b>



Includes: Mounting Bushing (Short - 0.395" - 10 mm Long) (2), Mounting Bushing (Long - 0.595" - 15 mm Long) (2), Clutch Shim (0.015" - 0.38mm Thick) (6), Pulley Retaining Ring (1), Shaft Bolt (1)

Gaskets	
Gasket - Head (Early)	Metal <b>G12-2161</b>
Gasket - Head (Late)	Metal <b>G12-2163</b>
Gasket - Head (Mid)	Metal <b>G12-2162</b>
Gasket Kit (Metal) (Early)	Green HNBR <b>K12-2110</b>

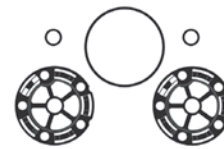

Includes: Head Gasket (Early) (2), Case O-Ring (1), Suction / Discharge Port O-Ring (2)

Gasket Kit (Metal) (Late)	
	Green HNBR <b>K12-2120</b>



Includes: Head Gasket (Late) (2), Case O-Ring (1), Suction / Discharge Port O-Ring (2)

## FORD

### FX15

#### Gaskets

Gasket Kit (Metal) (Mid) Green HNBR **K12-2115**

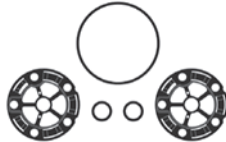

*Includes: Head Gasket (Mid) (2), Case O-Ring (1), Suction / Discharge Port O-Ring (2)*

#### Piston Components

Half Ball Shoe (7.490 - 7.495mm)	<b>P12-2020</b>
Half Ball Shoe (7.495 - 7.500mm)	<b>P12-2021</b>
Half Ball Shoe (7.500 - 7.505mm)	<b>P12-2022</b>
Half Ball Shoe (7.505 - 7.510mm)	<b>P12-2023</b>
Half Ball Shoe (7.510 - 7.515mm)	<b>P12-2024</b>
Half Ball Shoe (7.515 - 7.520mm)	<b>P12-2025</b>
Half Ball Shoe (7.520 - 7.525mm)	<b>P12-2026</b>
Half Ball Shoe (7.525 - 7.530mm)	<b>P12-2027</b>
Half Ball Shoe (7.530 - 7.535mm)	<b>P12-2028</b>
Half Ball Shoe (7.535 - 7.540mm)	<b>P12-2029</b>
Piston Ring (0.813mm) (Standard)	<b>P12-3100</b>
Piston Ring (1.12mm) (Oversize)	<b>P12-3101</b>

#### Shaft Seals

Felt Wiper - Wick Type	<b>S13-4101</b>
Lip Seal (Black Rubber Coated)	Nitrile <b>S12-1005</b>
Lip Seal (Black Rubber Coated) (O.E.)	Nitrile <b>S12-1006</b>
Lip Seal Kit	Black Nitrile <b>K12-3011</b>



*Includes: Lip Seal Retaining Ring (1), Shaft Bolt (1), Lip Seal (1), Felt Wiper (1), Lip Seal Protector (Plastic-16 Spline) (1).*

#### Shipping Closures

Shipping Closure (Use with F12-5106, Bolt, 40mm)	<b>C12-5102</b>
Shipping Pad (Use with C12-4105)	<b>C13-3000</b>
Shipping Plate (Use 2 C13-3000, F12-2105 & F12-3105)	<b>C12-4105</b>

#### Tools

Helical Insert Drill for 8-1.25mm Inserts	<b>T10-6053</b>
---	-----------------

#### Tools

Helical Insert Tap 8-1.25mm	<b>T10-6254</b>
Helical Insert Tool 8-1.25mm - Bolt Style	<b>T10-6554</b>
Lip Seal Protector (16 Spline) (Metal)	<b>T12-1003</b>
Lip Seal Protector (21 Spline) (Plastic)	<b>T12-1002</b>
Piston Ring Expansion Cone (Requires T13-3010)	<b>T12-3000</b>
Piston Ring Installer	<b>T13-3010</b>
Shaft Seal Protector (21 Spline)	<b>T95-1396</b>
Shaft Seal Protector, Adjustable	<b>T95-1227</b>
Shaft Seal Remover	<b>LD99-1326</b>
Helical Insert Repair Kit (8-1.25mm)	<b>K10-1180</b>



*Includes: Helical Inserts (25), Drill (1), Tap (1), Installation Tool - Bolt Style (1)*



## FORD

### LARGE SCROLL

O-Rings	R134a and R-12 Compatible	Green HNBR	Black Nitrile
Control Valve Cover Gasket		<b>M94-2102</b>	<b>M94-1002</b>
Front Case O-Ring		<b>M65-2135</b>	<b>M65-1035</b>
Internal Orifice Tube O-Ring		<b>M25-2101</b>	<b>M25-1001</b>
Rear Stationary Scroll O-Ring		<b>M55-2101</b>	
Suction / Discharge Port O-Ring		<b>M96-2144</b>	<b>M96-1044</b>
<b>Bearings</b>			
Nose Bearing (12mm x 28mm x 8mm)	<b>B25-2111</b>		
Clutch Bearing (35mm x 50mm x 20mm)	<b>B25-1102</b>		
<b>Chemicals</b>			
Ultra PAG Oil 46 - 6pk, 8 oz Bottle	<b>MT3012</b>		
Ultra PAG Oil 46 - 6pk, Quart Bottle	<b>MT3018</b>		
Ultra PAG Oil 46 - Drum (52 gal)	<b>A10-6163</b>		
<b>Control Valves</b>			
Control Valve for Ford Scroll	<b>A12-5100</b>		
<b>Fasteners</b>			
Bolt - Rear Scroll / Shipping Plate (Use w/ C12-5102)	<b>F12-2108</b>		
Retaining Ring - Lip Seal	<b>F55-4000</b>		
Retaining Ring - Pulley	<b>F25-4112</b>		
Shim - Clutch (0.38mm)	<b>F25-3112</b>		
Shim - Clutch (0.76mm)	<b>F25-3113</b>		
<b>Gaskets</b>			
Gasket - Ford Scroll (Large)	Green HNBR <b>G12-3101</b>		
<b>Shaft Seals</b>			
Lip Seal (Black Rubber Coated)	Nitrile <b>S55-1001</b>		
Lip Seal Kit (Rubber Coated Seal)	Black Nitrile <b>K55-3006</b>		



Includes: Lip Seal Retaining Ring (1), Lip Seal (1)

<b>Shipping Closures</b>	
Shipping Closure (Use with F12-2108 Bolt, 30mm)	<b>C12-5102</b>
<b>Tools</b>	
Shaft Seal Protector, Adjustable	<b>T95-1225</b>

## FORD SCROLL

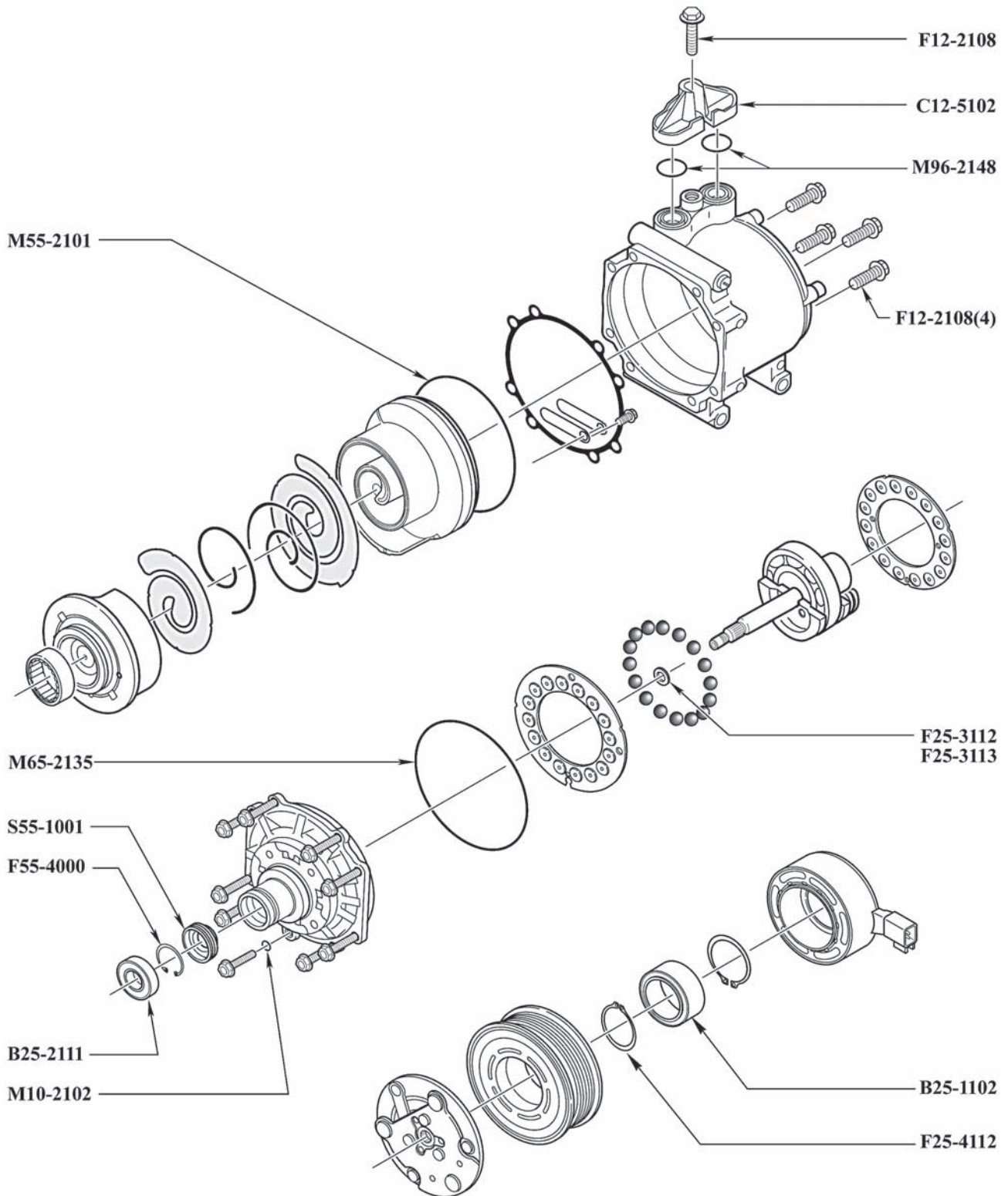

## FORD SCROLL

O-Rings	R134a and R-12 Compatible	Green HNBR	Black Nitrile
Front Case O-Ring		<b>M65-2135</b>	<b>M65-1035</b>
Oil Drain Plug O-Ring		<b>M10-2102</b>	<b>M10-1002</b>
Rear Stationary Scroll O-Ring		<b>M55-2101</b>	
Switch Port O-Ring		<b>M96-2148</b>	<b>M96-1048</b>

Bearings	
Nose Bearing (12mm x 28mm x 8mm)	<b>B25-2111</b>
Clutch Bearing (35mm x 50mm x 20mm)	<b>B25-1102</b>

Chemicals	
Ultra PAG Oil 46 - 6pk, 8 oz Bottle	<b>MT3012</b>
Ultra PAG Oil 46 - 6pk, Quart Bottle	<b>MT3018</b>
Ultra PAG Oil 46 - Drum (52 gal)	<b>A10-6163</b>

Clutch Components	
Clutch Coil - 05-02 Explorer/05-03 Crown Victoria	<b>H12-7310</b>
Clutch Coil (European)	<b>H12-7311</b>
Clutch Hub - Total OD: 107mm (05-03 Crown Vic)	<b>H12-7007</b>

Fasteners	
Bolt - Rear Scroll / Shipping Plate (Use w/ C12- F12-2108 5102)	
Retaining Ring - Lip Seal	<b>F55-4000</b>
Retaining Ring - Pulley	<b>F25-4112</b>
Shim - Clutch (0.38mm)	<b>F25-3112</b>
Shim - Clutch (0.76mm)	<b>F25-3113</b>

Gaskets	
O-Ring Kit	Black Nitrile <b>K12-2026</b>

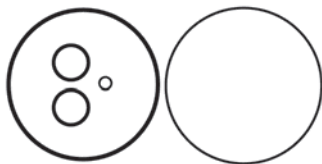

*Includes: Rear Stationary Scroll O-Ring(1), Case O-Ring(1), Oil Drain Plug O-Ring(1), Switch Port O-Ring(2),*

Shaft Seals	
Lip Seal (Black Rubber Coated)	Nitrile <b>S55-1001</b>

Shaft Seals	
Lip Seal Kit (Rubber Coated Seal)	Black Nitrile <b>K55-3006</b>



*Includes: Lip Seal Retaining Ring (1), Lip Seal (1)*

Shipping Closures	
Shipping Closure (Use with F12-2108 Bolt, 30mm)	<b>C12-5102</b>

Tools	
Shaft Seal Protector, Adjustable	<b>T95-1225</b>

## GM/HARRISON

A6

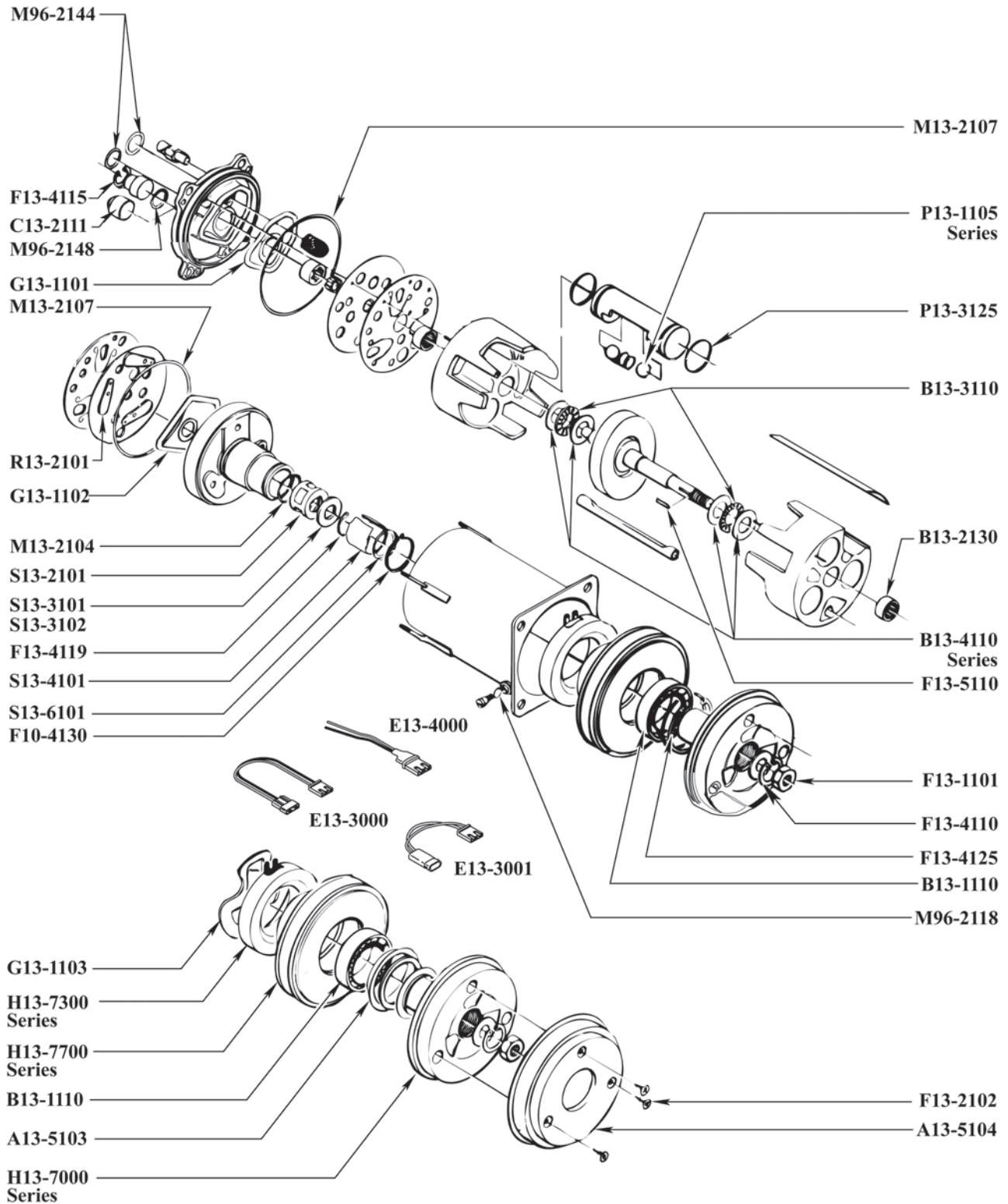

## GM/HARRISON

A6

O-Rings	R134a and R-12 Compatible	Green HNBR	Black Nitrile
Carbon Shaft Seal O-Ring		<b>M96-2134</b>	<b>M96-1034</b>
Case O-Ring		<b>M13-2107</b>	<b>M13-1007</b>
High Pressure Relief Valve O-Ring		<b>M96-2118</b>	<b>M96-1018</b>
Oil Pickup Tube O-Ring		<b>M96-2102</b>	<b>M96-1002</b>
Shaft Seal Seat O-Ring		<b>M13-2104</b>	<b>M13-1004</b>
Suction / Discharge Port O-Ring		<b>M96-2144</b>	<b>M96-1044</b>
Superheat Adapter O-Ring (Beveled)		<b>M13-2103</b>	<b>M13-1003</b>
Superheat Adapter O-Ring (Captive)		<b>M13-2111</b>	<b>M13-1011</b>
Switch Port O-Ring		<b>M96-2148</b>	<b>M96-1048</b>
<b>Bearings</b>		<b>Electrical</b>	
Case Bearing (15.9mm x 21mm x 12.5mm)	<b>B13-2130</b>	Hi Side Low Pressure Cut-Off Switch (Brown)	<b>E13-1012</b>
Clutch Bearing (40mm x 62mm x 20.6mm)	<b>B13-1110</b>	High Pressure Cut-Off Switch (Lt Blue)	<b>E13-1009</b>
Thrust Bearing (19.2mm x 37.2mm x 2mm)	<b>B13-3110</b>	High Pressure Cut-Off Switch Kit	<b>E13-1022</b>
Thrust Race (2.34mm) (Standard)	<b>B13-4110</b>	Low Pressure Cut-Off Switch Kit	<b>E13-1019</b>
Thrust Race (2.58mm) (Oversize)	<b>B13-4117</b>	Radiator Fan Pressure Switch (Gray)	<b>E13-1017</b>
Thrust Race (2.60mm) (Oversize)	<b>B13-4118</b>	Radiator Fan Pressure Switch Kit	<b>E13-1016</b>
<b>Chemicals</b>		<b>Fasteners</b>	
Ultra PAG Oil 150 - 6pk, 8 oz Bottle	<b>MT3014</b>	Bolt - Shipping Plate	<b>F13-2100</b>
Ultra PAG Oil 150 - 6pk, Quart Bottle	<b>MT3020</b>	Screw - Clutch Dust Cover	<b>F13-2102</b>
Ultra PAG Oil 150 - Drum (52 gal)	<b>A10-6165</b>	Helical Insert - Manifold Bolt (10-1.5mm x 15mm)	<b>F10-6218</b>
<b>Clutch Components</b>		Helical Insert - Manifold Bolt (10-1.5mm x 20mm)	<b>F10-6217</b>
Clutch Bearing Dust Shield Pad	<b>A13-5103</b>	Locknut - Clutch Hub (Flanged)	<b>F13-1101</b>
Clutch Dust Cover	<b>A13-5104</b>	Nut - Valve Plate	<b>F13-1120</b>
Clutch Hub - Long Shaft (New)	<b>H13-7005</b>	Rivet - Valve Plate	<b>F13-7105</b>
Clutch Hub - Long Shaft (Reman)	<b>H13-7004</b>	Shaft Key	<b>F13-5110</b>
Clutch Hub - Short Shaft (New)	<b>H13-7003</b>	Retaining Ring - Clutch Coil (Beveled)	<b>F13-4125</b>
Clutch Hub - Short Shaft (Reman)	<b>H13-7002</b>	Retaining Ring - Clutch Hub	<b>F13-4110</b>
Clutch Coil - 12 Volt (Reman)	<b>H13-7305</b>	Retaining Ring - Pulley	<b>F10-4130</b>
Clutch Coil - 24 Volt	<b>H13-7302</b>	Retaining Ring - Shaft Seal Seat	<b>F13-4119</b>
Clutch Coil - OD/ID: 92.7mm / 71.5mm	<b>H13-7306</b>	Retaining Ring - Shaft Seal Seat (Beveled)	<b>F13-4120</b>
Clutch Pulley - 1 Groove w/ Bearing (143.25mm)	<b>H13-7706</b>	Retaining Ring - Switch Port	<b>F13-4115</b>
Clutch Pulley - 2 Groove w/ Bearing (143.25mm)	<b>H13-7707</b>	Retaining Ring Kit	<b>K13-5110</b>
<b>Electrical</b>			
Clutch Coil Connector (Spade) (Pre 1996)	<b>E13-4000</b>	<p><i>Includes: Clutch to Pulley Retaining Ring (1), Flanged Clutch Hub Nut (1), Clutch Hub Retaining Ring (1), Switch Port Retaining Ring (1), Shaft Seal Seat Retaining Ring (Beveled) (1), Coil Retaining Ring (Beveled) (1)</i></p>	
Clutch Coil Extender - 12" (Pre 1996)	<b>E13-3000</b>		
GM High Pressure Switch Connector	<b>E13-4003</b>		
GM Low Pressure Switch Connector	<b>E13-4002</b>		
Straight Pigtail Adapter (Male Flat Spade to Female 8mm Pin)	<b>E13-3001</b>		
Condenser Fan Pressure Switch (Purple)	<b>E13-1011</b>		
Hi Side Low Pressure Cut-Off Switch (Black)	<b>E13-1018</b>		

## GM/HARRISON

A6

### Gaskets

Gasket - Coil	Foam Rubber	<b>G13-1103</b>
Gasket - Front Flange (100 per)	Mylar	<b>G13-1102-100</b>
O-Ring Kit	Green HNBR	<b>K13-2105</b>



*Includes: Case O-Ring(2), HPRV O-Ring(1), Suction / Discharge Port O-Ring (2)*

### Dust Cover Kit

**K13-5101**



*Includes: Clutch Dust Cover (1), Clutch Dust Cover Screws (3), Coil Gasket (Foam Rubber) (1)*

### O-Ring Kit

Black Nitrile **K13-2005**

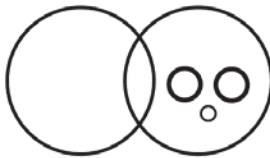

*Includes: Case O-Ring(2), HPRV O-Ring(1), Suction / Discharge Port O-Ring (2)*

### Piston Components

Piston Ball (15.87mm) (Standard)	<b>P13-1105</b>
Piston Ball (15.89mm) (Oversize)	<b>P13-1110</b>
Piston Ball (15.90mm) (Oversize)	<b>P13-1120</b>
Piston Ball (15.91mm) (Oversize)	<b>P13-1115</b>
Piston Ring (0.64mm) (Standard)	<b>P13-3125</b>

### Reeds and Valve Plates

Reed - Discharge Valve	<b>R13-2101</b>
------------------------	-----------------

### Service Items

High Pressure Relief Valve	<b>A13-5161</b>
----------------------------	-----------------

### Shaft Seals

Carbon Shaft Seal	HNBR	<b>S13-2101</b>
Ceramic Shaft Seal Seat		<b>S13-3101</b>
Felt Wiper - Wick Type		<b>S13-4101</b>
Felt Wiper Retainer		<b>S13-6101</b>
Metal Shaft Seal Seat		<b>S13-3102</b>

### Shaft Seals

Carbon Shaft Seal Kit	Green HNBR	<b>K13-3110</b>
-----------------------	------------	-----------------



*Includes: Shaft Seal Seat Retaining Ring (Beveled) (1), Carbon Shaft Seal (1), Metal Shaft Seal Seat (1), Shaft Seal Seat O-Ring (1)*

### Carbon Shaft Seal Kit

Green HNBR **K13-3115**



*Includes: Carbon Shaft Seal (1), Metal Shaft Seal Seat (1), Shaft Seal Seat O-Ring (1), Shaft Seal Retaining Ring (1), Felt Wiper (1), Felt Wiper Retainer (1)*

### Carbon Shaft Seal Kit (Ceramic)

Green HNBR **K13-3105**



*Includes: Carbon Shaft Seal (1), Ceramic Shaft Seal Seat (1), Shaft Seal Seat O-Ring (1), Shaft Seal Retaining Ring (1), Felt Wiper (1), Felt Wiper Retainer (1)*

### Carbon Shaft Seal Kit (Ceramic)

Green HNBR **K13-3120**

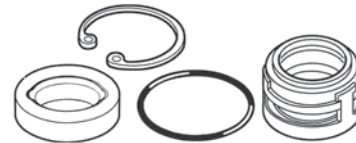

*Includes: Shaft Seal Seat Retaining Ring (Beveled) (1), Carbon Shaft Seal (1), Ceramic Shaft Seal Seat (1), Shaft Seal Seat O-Ring (1)*

### Shipping Closures

Plug - Aluminum Dummy	<b>C13-2111</b>
Shipping Pad (Use with C13-4100 or C13-4101)	<b>C13-3000</b>
Shipping Plate (Rectangular) (Use with 2 C13-3000)	<b>C13-4100</b>
Shipping Plate (Rounded) (Use with 2 C13-3000)	<b>C13-4101</b>

## GM/HARRISON

A6

### Tools

Ceramic/Metal Shaft Seal Seat Remover / Installer	<b>T13-1037</b>
Clutch Plate Installer	<b>T13-3041</b>
Clutch Plate Remover	<b>T13-3042</b>
O-Ring Installation Tool	<b>LD99-460</b>
Retaining Ring Remover	<b>LD99-1170</b>
Shaft Seal Protector	<b>T13-1035</b>
Shaft Seal Protector, Adjustable	<b>T95-1228</b>

## GM/HARRISON

### DA6, HR6, HR6HE

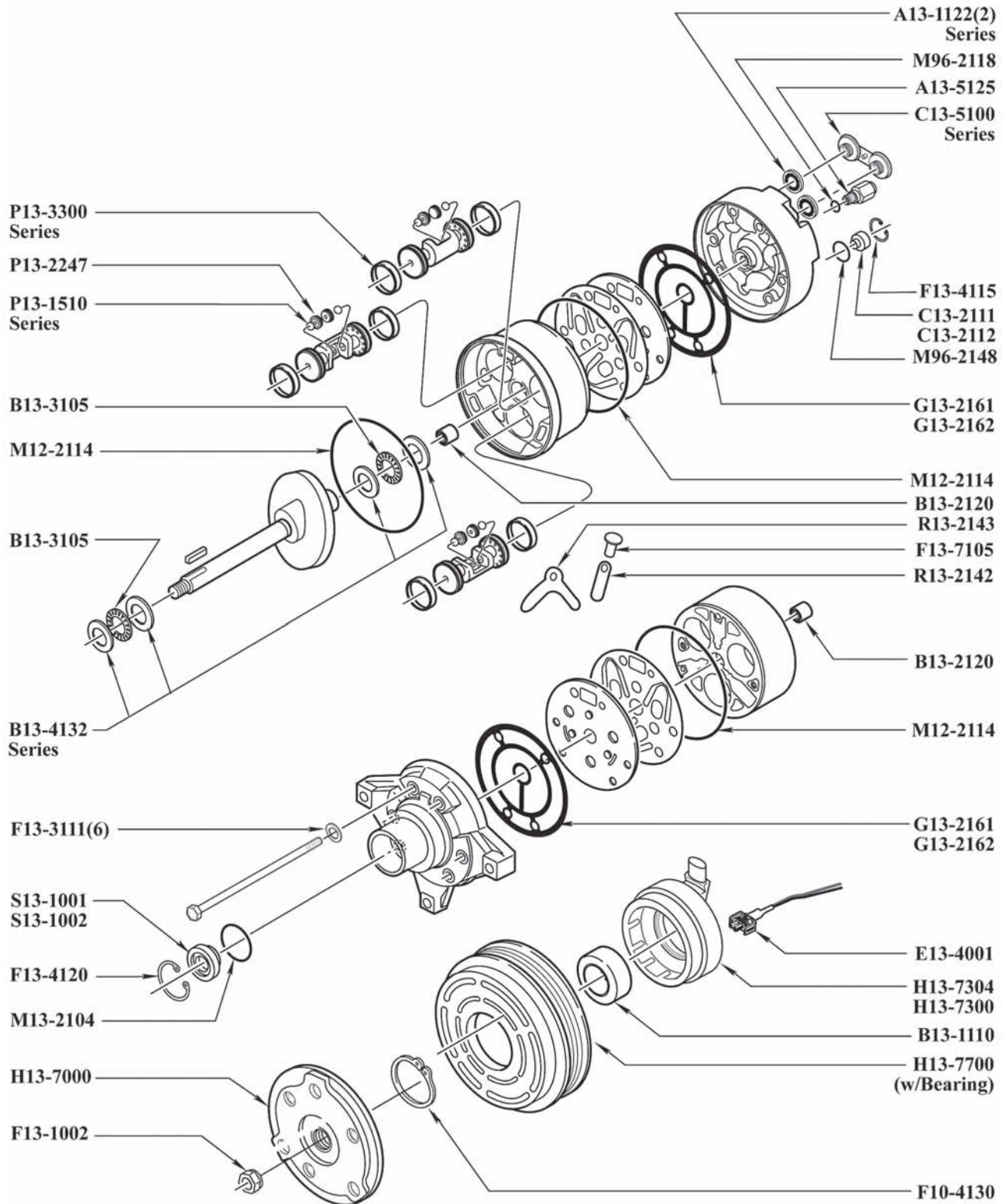



## GM/HARRISON

### DA6, HR6, HR6HE

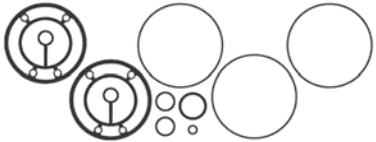
O-Rings	R134a and R-12 Compatible	Green HNBR	Black Nitrile
Case O-Ring		<b>M12-2114</b>	<b>M12-1014</b>
Discharge Crossover O-Ring		<b>M96-2110</b>	<b>M96-1010</b>
High Pressure Relief Valve O-Ring		<b>M96-2118</b>	<b>M96-1018</b>
Lip Seal O-Ring		<b>M13-2104</b>	<b>M13-1004</b>
Suction / Discharge Port O-Ring		<b>M96-2144</b>	<b>M96-1044</b>
Suction / Discharge Port Oval O-Ring		<b>A13-1110</b>	
Switch Port O-Ring		<b>M96-2148</b>	<b>M96-1048</b>
Bearings		Electrical	
Case Bearing (14.3mm x 19.1mm x 15.7mm)	<b>B13-2120</b>	Radiator Fan Pressure Switch (Gray)	<b>E13-1017</b>
Clutch Bearing (40mm x 62mm x 20.6mm)	<b>B13-1110</b>	Radiator Fan Pressure Switch Kit	<b>E13-1016</b>
Thrust Bearing (14.7mm x 29mm x 2.4mm) (Pre 1995)	<b>B13-3105</b>	Fasteners	
Thrust Race (2.13mm)	<b>B13-4132</b>	Bolt - Adapter Block	<b>F13-2111</b>
Thrust Race (2.19mm)	<b>B13-4134</b>	Bolt - Shipping Plate (For C13-4100)	<b>F13-2153</b>
Thrust Race (2.21mm)	<b>B13-4135</b>	Helical Insert - Manifold Bolt (10-1.5mm x 15mm)	<b>F10-6218</b>
Thrust Race (2.29mm)	<b>B13-4139</b>	Helical Insert - Manifold Bolt (10-1.5mm x 20mm)	<b>F10-6217</b>
Chemicals		Locknut - Clutch Hub	<b>F13-1002</b>
Ultra PAG Oil 150 - 6pk, 8 oz Bottle	<b>MT3014</b>	Rivet - Valve Plate	<b>F13-7105</b>
Ultra PAG Oil 150 - 6pk, Quart Bottle	<b>MT3020</b>	Retaining Ring - Lip Seal (Beveled)	<b>F13-4120</b>
Ultra PAG Oil 150 - Drum (52 gal)	<b>A10-6165</b>	Retaining Ring - Pulley	<b>F10-4130</b>
Clutch Components		Retaining Ring - Switch Port	<b>F13-4115</b>
Clutch Coil w/ Pin - Black Band (Straight Connector)	<b>H13-7300</b>	Washer - Head Bolt	<b>F13-3111</b>
Clutch Coil w/Spade - Blue Band	<b>H13-7304</b>	Gaskets	
Clutch Hub - Short Shaft (Steel)	<b>H13-7000</b>	Gasket - Head (6.9mm Bolt Hole Diameter)	Metal <b>G13-2161</b>
Clutch Pulley - 6 Groove w/ Bearing (107.95mm)	<b>H13-7700</b>	Gasket - Head (7.8mm Bolt Hole Diameter)	Metal <b>G13-2162</b>
Electrical		Gasket Kit (Metal) (6.9mm Bolt Hole)	Green HNBR <b>K13-2115</b>
Clutch Coil Connector (Spade)	<b>E13-4000</b>		
Clutch Coil Extender - 12"	<b>E13-3000</b>		
GM High Pressure Switch Connector	<b>E13-4003</b>		
GM Low Pressure Switch Connector	<b>E13-4002</b>		
Straight Pigtail (Male 8mm Pin, with Diode)	<b>E13-4001</b>		
Straight Pigtail Adapter (Male 8mm Pin to Female Flat Spade)	<b>E13-3002</b>		
Straight Pigtail Adapter (Male Flat Spade to Female 8mm Pin)	<b>E13-3001</b>		
Condenser Fan Pressure Switch (Purple)	<b>E13-1011</b>		
Hi Side Low Pressure Cut-Off Switch (Black)	<b>E13-1018</b>		
Hi Side Low Pressure Cut-Off Switch (Brown)	<b>E13-1012</b>		
High Pressure Cut-Off Switch (Lt Blue)	<b>E13-1009</b>		
High Pressure Cut-Off Switch Kit	<b>E13-1022</b>		
Low Pressure Cut-Off Switch Kit	<b>E13-1019</b>		

Includes: Head Gasket (Metal) (6.9 mm Bolt Holes) (2), Switch Port O-Ring (1), Case O-Ring (3), Suction / Discharge Port O-Ring (2), Discharge Crossover O-Ring (1)

## GM/HARRISON

DA6, HR6, HR6HE

### Gaskets

Gasket Kit (Metal) (7.8mm Bolt Hole) Green HNBR **K13-2116**

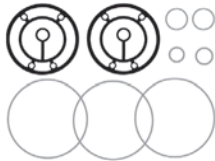

*Includes: Head Gasket (Metal) (7.8 mm Bolt Holes) (2), Switch Port O-Ring (1), Case O-Ring (3), Suction / Discharge Port O-Ring (2), Discharge Crossover O-Ring (1)*

Gasket Kit (Metal) (6.9mm Bolt Hole) Black Nitrile **K13-2015**

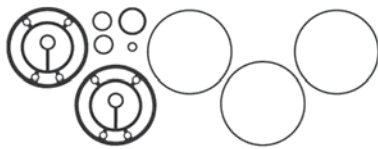

*Includes: Head Gasket (6.9 mm Bolt Holes) (2), Switch Port O-Ring (1), Case O-Ring (3), Suction / Discharge Port O-Ring (2), Discharge Crossover O-Ring (1)*

Gasket Kit (Metal) (7.8mm Bolt Hole) Black Nitrile **K13-2016**



*Includes: Head Gasket (Metal) (7.8 mm Bolt Holes) (2), Switch Port O-Ring (1), Case O-Ring (3), Suction / Discharge Port O-Ring (2), Discharge Crossover O-Ring (1)*

### Piston Components

Piston Ball (14.00mm) (Standard)	<b>P13-1510</b>
Piston Ball (14.02mm) (Oversize)	<b>P13-1520</b>
Piston Ball (14.04mm) (Oversize)	<b>P13-1530</b>
Piston Ball Shoe	<b>P13-2247</b>
Piston Ring (0.76mm) (Standard)	<b>P13-3330</b>
Piston Ring (3.18mm) (Split Oversize)	<b>P13-3305</b>

### Reeds and Valve Plates

Reed - Discharge Valve (Double Prong)	<b>R13-2143</b>
Reed - Discharge Valve (Single Prong)	<b>R13-2142</b>

### Service Items

High Pressure Relief Valve	<b>A13-5125</b>
15mm-Slim-Line Sealing Washer (#10)	<b>A13-1137</b>
Adapter Block	<b>A13-1138</b>

### Service Items

Sealing Washer - 3/4" Silver (Thin)	<b>A13-1123</b>
Sealing Washer - 5/8" Black (Thick)	<b>A13-1122</b>
Sealing Washer - 5/8" Green (Thick)	<b>A13-1126</b>
Sealing Washer - 5/8" Red (Thick)	<b>A13-1127</b>
Sealing Washer - 5/8" Silver (Thin)	<b>A13-1124</b>
Sealing Washer - 5/8" Yellow (Thick)	<b>A13-1128</b>
Sealing Washer Pilot (Long)	<b>A13-5109</b>
Sealing Washer Pilot (Short)	<b>A13-5110</b>
Adapter Kit	<b>K13-5104</b>



*Includes: 5/8" Thick Sealing Washer (Black) (1), 3/4" Thin Sealing Washer (Silver) (1), 5/8" Thin Sealing Washer (Silver) (1), 5/8" Thick Sealing Washer (Red) (1), 5/8" Thick Sealing Washer (Yellow) (1), Adapter Block (1), Block Bolt (1)*

Sealing Washer Kit (Single Use) **K13-2126**



*Includes: 5/8" Thick (Black) (2), 5/8" Thin (Silver) (2), 5/8" Thick (Green) (1), 5/8" Thick (Red) (1), 5/8" Thick (Yellow) (1), #10 Slim-Line (2), Pilot (Long) (1), Pilot (Short) (1)*

Sealing Washer Kit (Single Use) **K13-2135**



*Includes: 5/8" Silver Sealing Washers (2)*

### Shaft Seals

Lip Seal (Double)	Nitrile <b>S13-1002</b>
Lip Seal (Single) (O.E.)	Nitrile <b>S13-1001</b>

## GM/HARRISON

DA6, HR6, HR6HE

### Shaft Seals

Lip Seal Kit (Single Lip Seal) Green HNBR **K13-3125**



Includes: Lip Seal Retaining Ring (1), Lip Seal O-Ring (1), Lip Seal (1)

### Shipping Closures

Plug - Aluminum Dummy	<b>C13-2111</b>
Plug - Hollow Aluminum Dummy	<b>C13-2112</b>
Shipping Closure for O-Rings	<b>C13-5100</b>
Shipping Closure for Sealing Washer - 5/8" Ports	<b>C13-5101</b>
Shipping Pad (Use with C13-4100)	<b>C13-3000</b>
Shipping Plate for O-Rings (Metal)	<b>C13-4100</b>

### Tools

Ceramic/Metal Shaft Seal Seat Remover / Installer	<b>T13-1037</b>
Clutch Plate Installer	<b>T13-3047</b>
Clutch Plate Remover	<b>LD22-121</b>
Clutch Plate Remover	<b>T13-3046</b>
Coil Installer	<b>LD22-292</b>
Piston Ring Expansion Cone (Requires T13-3010)	<b>T13-3048</b>
Piston Ring Installer	<b>T13-3010</b>
Shaft Seal Protector (Early)	<b>T13-1036</b>
Shaft Seal Protector (Late)	<b>T13-1035</b>
Shaft Seal Protector, Adjustable	<b>T95-1228</b>
Shaft Seal Seat Installer / Remover (O.E.)	<b>T60-3001</b>

## GM/HARRISON

### HD6, HT6

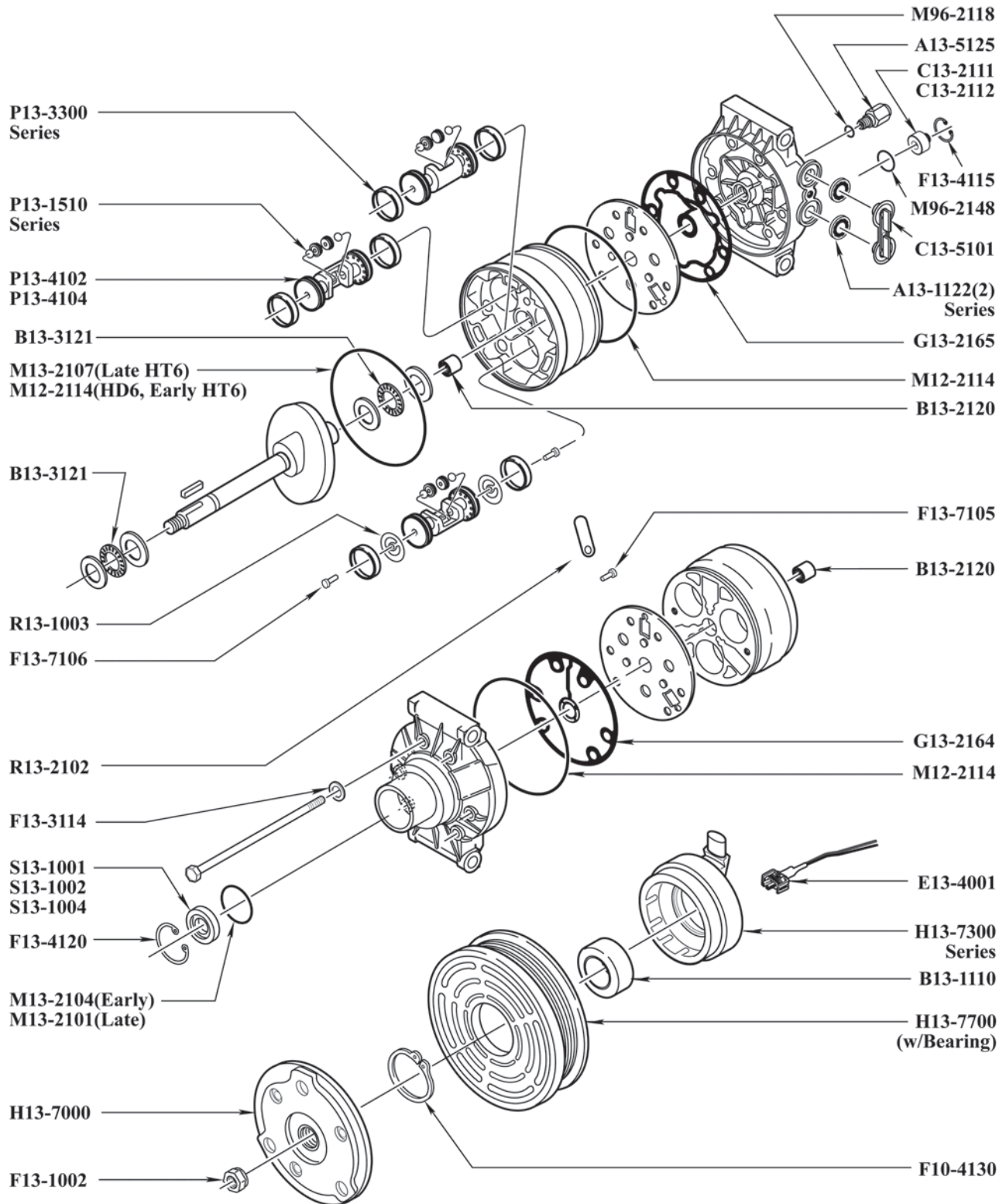

## GM/HARRISON

### HD6, HT6

O-Rings	R134a and R-12 Compatible	Green HNBR	Black Nitrile
Case O-Ring (Center [Late HT6])		<b>M13-2107</b>	<b>M13-1007</b>
Case O-Ring (Front/Rear & Center[HD6, Early HT6])		<b>M12-2114</b>	<b>M12-1014</b>
Discharge Crossover O-Ring		<b>M96-2110</b>	<b>M96-1010</b>
High Pressure Relief Valve O-Ring		<b>M96-2118</b>	<b>M96-1018</b>
Lip Seal O-Ring (Large)(Late)		<b>M13-2101</b>	<b>M13-1001</b>
Lip Seal O-Ring (Small)(Early)		<b>M13-2104</b>	<b>M13-1004</b>
Switch Port O-Ring		<b>M96-2148</b>	<b>M96-1048</b>
Bearings		Fasteners	
Case Bearing (14.3mm x 19.1mm x 15.7mm)	<b>B13-2120</b>	Bolt - Adapter Block	<b>F13-2111</b>
Clutch Bearing (35mm x 52mm x 22mm) (Small Nose)	<b>B20-1108</b>	Bolt - Shipping Plate (For C13-4100)	<b>F13-2153</b>
Clutch Bearing (40mm x 62mm x 20.6mm)	<b>B13-1110</b>	Helical Insert - Manifold Bolt (10-1.5mm x 15mm)	<b>F10-6218</b>
Thrust Bearing (14.7mm x 40.8mm x 3mm)	<b>B13-3121</b>	Helical Insert - Manifold Bolt (10-1.5mm x 20mm)	<b>F10-6217</b>
Chemicals		Locknut - Clutch Hub	<b>F13-1002</b>
Ultra PAG Oil 150 - 6pk, 8 oz Bottle	<b>MT3014</b>	Rivet - Discharge Reed	<b>F13-7105</b>
Ultra PAG Oil 150 - 6pk, Quart Bottle	<b>MT3020</b>	Rivet - Piston	<b>F13-7106</b>
Ultra PAG Oil 150 - Drum (52 gal)	<b>A10-6165</b>	Retaining Ring - Lip Seal (Beveled)	<b>F13-4120</b>
Clutch Components		Retaining Ring - Pulley	<b>F10-4130</b>
Clutch Coil w/ Pin - Black Band (Straight Connector)	<b>H13-7300</b>	Retaining Ring - Pulley	<b>F25-4112</b>
Clutch Coil w/ Pin - Tan Band (Angled Connector)	<b>H13-7301</b>	Retaining Ring - Switch Port	<b>F13-4115</b>
Clutch Hub - Short Shaft (Steel)	<b>H13-7000</b>	Washer - Head Bolt	<b>F13-3114</b>
Clutch Pulley - 6 Groove w/ Bearing (107.95mm)	<b>H13-7700</b>	Gaskets	
Electrical		Gasket - Front Head	Metal <b>G13-2164</b>
Clutch Coil Connector (Spade)	<b>E13-4000</b>	Gasket - Rear Head	Metal <b>G13-2165</b>
Clutch Coil Extender - 12"	<b>E13-3000</b>	Gasket Kit (Metal)(HD6, Early HT6)	Green HNBR <b>K13-2118</b>
GM High Pressure Switch Connector	<b>E13-4003</b>		
GM Low Pressure Switch Connector	<b>E13-4002</b>		
Straight Pigtail (Male 8mm Pin, with Diode)	<b>E13-4001</b>	<p><i>Includes: Front Head Gasket(1), Rear Head Gasket(1), Case O-Rings(3), PRV O-Ring(1), Switch Port O-Ring(1)</i></p>	
Straight Pigtail Adapter (Male 8mm Pin to Female Flat Spade)	<b>E13-3002</b>	<p>Gasket Kit (Metal)(Late HT6)      Green HNBR <b>K13-2117</b></p> 	
Straight Pigtail Adapter (Male Flat Spade to Female 8mm Pin)	<b>E13-3001</b>	<p><i>Includes: Head Gasket - Front(Metal) (1), Head Gasket - Rear(Metal) (1), Switch Port O-Ring (1), Case O-Ring (3), Discharge Crossover O-Ring (1)</i></p>	
Condenser Fan Pressure Switch (Purple)	<b>E13-1011</b>		
Hi Side Low Pressure Cut-Off Switch (Black)	<b>E13-1018</b>		
Hi Side Low Pressure Cut-Off Switch (Brown)	<b>E13-1012</b>		
High Pressure Cut-Off Switch (Lt Blue)	<b>E13-1009</b>		
High Pressure Cut-Off Switch Kit	<b>E13-1022</b>		
Low Pressure Cut-Off Switch Kit	<b>E13-1019</b>		
Radiator Fan Pressure Switch (Gray)	<b>E13-1017</b>		
Radiator Fan Pressure Switch Kit	<b>E13-1016</b>		

## GM/HARRISON

### HD6, HT6

#### Gaskets

Gasket Kit (Metal)(HD6, Black Nitrile **K13-2018**  
Early HT6)

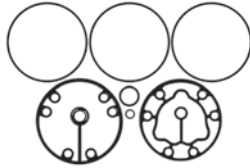

*Includes: Head Gasket - Front(Metal) (1), Head Gasket - Rear(Metal) (1), Switch Port O-Ring (1), Case O-Ring (3), Discharge Crossover O-Ring (1)*

Gasket Kit (Metal)(Late HT6) Black Nitrile **K13-2017**



*Includes: Head Gasket - Front(Metal) (1), Head Gasket - Rear(Metal) (1), Switch Port O-Ring (1), Case O-Ring (3), Discharge Crossover O-Ring (1)*

#### Piston Components

Piston Ball (14.00mm) (Standard)	<b>P13-1510</b>
Piston Ball (14.02mm) (Oversize)	<b>P13-1520</b>
Piston Ball (14.04mm) (Oversize)	<b>P13-1530</b>
Piston Ring (0.76mm) (Standard)	<b>P13-3330</b>
Piston Ring (3.18mm) (Split Oversize)	<b>P13-3305</b>
Piston w/Reed (Oversize)	<b>P13-4104</b>
Piston w/Reed (Standard)	<b>P13-4102</b>

#### Reeds and Valve Plates

Reed - Discharge Valve	<b>R13-2102</b>
Reed - Suction Valve	<b>R13-1003</b>

#### Service Items

High Pressure Relief Valve	<b>A13-5125</b>
15mm-Slim-Line Sealing Washer (#10)	<b>A13-1137</b>
Adapter Block	<b>A13-1138</b>
Sealing Washer - 3/4" Silver (Thin)	<b>A13-1123</b>
Sealing Washer - 5/8" Black (Thick)	<b>A13-1122</b>
Sealing Washer - 5/8" Green (Thick)	<b>A13-1126</b>
Sealing Washer - 5/8" Red (Thick)	<b>A13-1127</b>
Sealing Washer - 5/8" Silver (Thin)	<b>A13-1124</b>
Sealing Washer - 5/8" Yellow (Thick)	<b>A13-1128</b>
Sealing Washer Pilot (Long)	<b>A13-5109</b>
Sealing Washer Pilot (Short)	<b>A13-5110</b>

#### Service Items

Adapter Kit **K13-5104**



*Includes: 5/8" Thick Sealing Washer (Black) (1), 3/4" Thin Sealing Washer (Silver) (1), 5/8" Thin Sealing Washer (Silver) (1), 5/8" Thick Sealing Washer (Red) (1), 5/8" Thick Sealing Washer (Yellow) (1), Adapter Block (1), Block Bolt (1)*

Sealing Washer Kit (Single Use) **K13-2126**



*Includes: 5/8" Thick (Black) (2), 5/8" Thin (Silver) (2), 5/8" Thick (Green) (1), 5/8" Thick (Red) (1), 5/8" Thick (Yellow) (1), #10 Slim-Line (2), Pilot (Long) (1), Pilot (Short) (1)*

Sealing Washer Kit (Single Use) **K13-2135**



*Includes: 5/8" Silver Sealing Washers (2)*

#### Shaft Seals

Lip Seal (Double)	Nitrile <b>S13-1002</b>
Lip Seal (Fat Shaft)(Late Model HT6)	Nitrile <b>S13-1004</b>
Lip Seal (Single) (O.E.)	Nitrile <b>S13-1001</b>
Lip Seal Kit (Double Lip Seal)	Green HNBR <b>K13-3126</b>



*Includes: Double Lip Seal (1), Double Lip Seal O-Ring - Small (1), Double Lip Seal O-Ring - Large (1), Retaining Ring (1),*

## GM/HARRISON

HD6, HT6

### Shaft Seals

Lip Seal Kit (Single Lip  
Seal - Large O-Ring)

Green HNBR **K13-3125**



*Includes: Lip Seal Retaining Ring (1), Lip Seal O-Ring (1), Lip Seal (1)*

### Shipping Closures

Plug - Aluminum Dummy	<b>C13-2111</b>
Plug - Hollow Aluminum Dummy	<b>C13-2112</b>
Shipping Closure for Sealing Washer - 5/8" Ports	<b>C13-5101</b>
Shipping Plate for O-Rings (Metal)	<b>C13-4100</b>

### Tools

Clutch Plate Installer	<b>T13-3047</b>
Clutch Plate Remover	<b>T13-3046</b>
Piston Ring Expansion Cone (Requires T13- 3010)	<b>T13-3048</b>
Piston Ring Installer	<b>T13-3010</b>
Shaft Seal Protector	<b>T13-1034</b>
Shaft Seal Protector, Adjustable	<b>T95-1228</b>
Shaft Seal Seat Installer / Remover (O.E.)	<b>T60-3001</b>

## GM/HARRISON

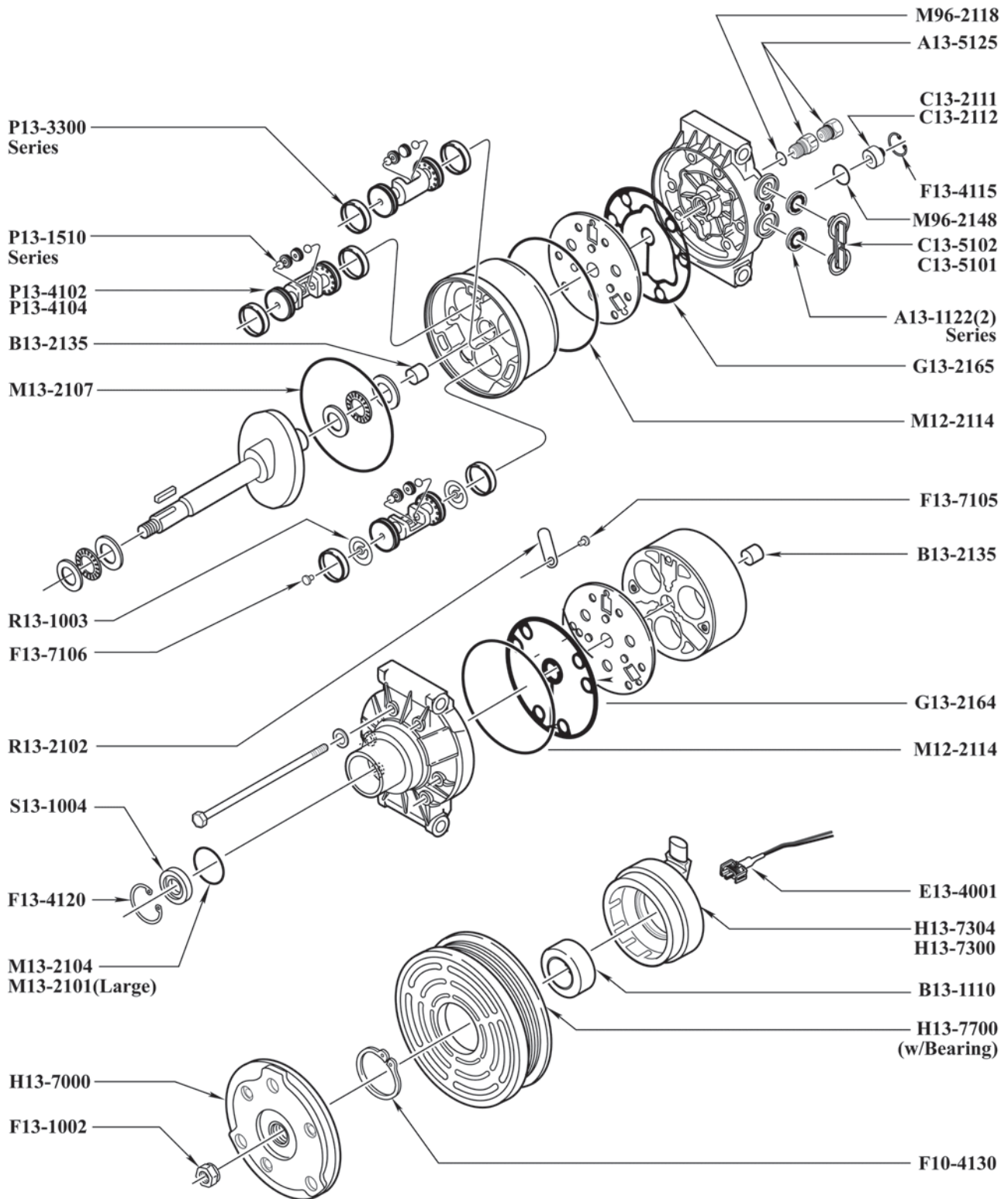

### HU6



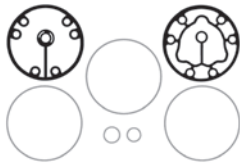

## GM/HARRISON

### HU6

O-Rings	R134a and R-12 Compatible	Green HNBR	Black Nitrile
Case O-Ring (Center)		<b>M13-2107</b>	<b>M13-1007</b>
Case O-Ring (Front/Rear)		<b>M12-2114</b>	<b>M12-1014</b>
High Pressure Relief Valve O-Ring		<b>M96-2118</b>	<b>M96-1018</b>
Lip Seal O-Ring (Large)		<b>M13-2101</b>	<b>M13-1001</b>
Lip Seal O-Ring (Small)(Early)		<b>M13-2104</b>	<b>M13-1004</b>
Switch Port O-Ring		<b>M96-2148</b>	<b>M96-1048</b>
<b>Bearings</b>		<b>Fasteners</b>	
Clutch Bearing (40mm x 62mm x 20.6mm)	<b>B13-1110</b>	Retaining Ring - Pulley	<b>F10-4130</b>
Shaft Bushing (16.1mm x 18.1mm x 20mm)	<b>B13-2135</b>	Retaining Ring - Switch Port	<b>F13-4115</b>
<b>Chemicals</b>		<b>Gaskets</b>	
Ultra PAG Oil 150 - 6pk, 8 oz Bottle	<b>MT3014</b>	Gasket - Front Head	Metal <b>G13-2164</b>
Ultra PAG Oil 150 - 6pk, Quart Bottle	<b>MT3020</b>	Gasket - Rear Head	Metal <b>G13-2165</b>
Ultra PAG Oil 150 - Drum (52 gal)	<b>A10-6165</b>	Gasket Kit (Metal)	Green HNBR <b>K13-2117</b>
<b>Clutch Components</b>		 <p><i>Includes: Head Gasket - Front(Metal) (1), Head Gasket - Rear(Metal) (1), Switch Port O-Ring (1), Case O-Ring (3), Discharge Crossover O-Ring (1)</i></p>	
Clutch Coil w/ Pin - Black Band (Straight Connector)	<b>H13-7300</b>	<b>Gasket Kit (Metal)</b> <b>Black Nitrile K13-2017</b>	
Clutch Coil w/Spade - Blue Band	<b>H13-7304</b>	 <p><i>Includes: Head Gasket - Front(Metal) (1), Head Gasket - Rear(Metal) (1), Switch Port O-Ring (1), Case O-Ring (3), Discharge Crossover O-Ring (1)</i></p>	
Clutch Hub - Short Shaft (Steel)	<b>H13-7000</b>		
Clutch Pulley - 6 Groove w/ Bearing (107.95mm)	<b>H13-7700</b>		
<b>Electrical</b>			
Clutch Coil Connector (Spade)	<b>E13-4000</b>		
Straight Pigtail (Male 8mm Pin, with Diode)	<b>E13-4001</b>		
Straight Pigtail Adapter (Male 8mm Pin to Female Flat Spade)	<b>E13-3002</b>		
Condenser Fan Pressure Switch (Purple)	<b>E13-1011</b>		
Hi Side Low Pressure Cut-Off Switch (Black)	<b>E13-1018</b>		
Hi Side Low Pressure Cut-Off Switch (Brown)	<b>E13-1012</b>		
High Pressure Cut-Off Switch (Lt Blue)	<b>E13-1009</b>		
High Pressure Cut-Off Switch Kit	<b>E13-1022</b>		
Low Pressure Cut-Off Switch Kit	<b>E13-1019</b>		
Radiator Fan Pressure Switch (Gray)	<b>E13-1017</b>		
Radiator Fan Pressure Switch Kit	<b>E13-1016</b>		
<b>Fasteners</b>		<b>Piston Components</b>	
Bolt - Adapter Block	<b>F13-2111</b>	Piston Ball (14.00mm) (Standard)	<b>P13-1510</b>
Helical Insert - Manifold Bolt (10-1.5mm x 15mm)	<b>F10-6218</b>	Piston Ball (14.02mm) (Oversize)	<b>P13-1520</b>
Helical Insert - Manifold Bolt (10-1.5mm x 20mm)	<b>F10-6217</b>	Piston Ball (14.04mm) (Oversize)	<b>P13-1530</b>
Locknut - Clutch Hub	<b>F13-1002</b>	Piston Ring (0.76mm) (Standard)	<b>P13-3330</b>
Rivet - Piston	<b>F13-7106</b>	Piston Ring (3.18mm) (Split Oversize)	<b>P13-3305</b>
Rivet - Valve Plate	<b>F13-7105</b>	Piston w/Reed (Oversize)	<b>P13-4104</b>
Retaining Ring - Lip Seal (Beveled)	<b>F13-4120</b>	Piston w/Reed (Standard)	<b>P13-4102</b>
		<b>Reeds and Valve Plates</b>	
		Reed - Discharge Valve	<b>R13-2102</b>
		Reed - Suction Valve	<b>R13-1003</b>
		<b>Service Items</b>	
		High Pressure Relief Valve	<b>A13-5125</b>

## GM/HARRISON

### HU6

#### Service Items

15mm-Slim-Line Sealing Washer (#10)	<b>A13-1137</b>
Adapter Block	<b>A13-1138</b>
Sealing Washer - 3/4" Silver (Thin)	<b>A13-1123</b>
Sealing Washer - 5/8" Black (Thick)	<b>A13-1122</b>
Sealing Washer - 5/8" Green (Thick)	<b>A13-1126</b>
Sealing Washer - 5/8" Red (Thick)	<b>A13-1127</b>
Sealing Washer - 5/8" Silver (Thin)	<b>A13-1124</b>
Sealing Washer - 5/8" Yellow (Thick)	<b>A13-1128</b>
Sealing Washer Pilot (Long)	<b>A13-5109</b>
Sealing Washer Pilot (Short)	<b>A13-5110</b>
Adapter Kit	<b>K13-5104</b>



*Includes: 5/8" Thick Sealing Washer (Black) (1), 3/4" Thin Sealing Washer (Silver) (1), 5/8" Thin Sealing Washer (Silver) (1), 5/8" Thick Sealing Washer (Red) (1), 5/8" Thick Sealing Washer (Yellow) (1), Adapter Block (1), Block Bolt (1)*

Sealing Washer Kit (Single Use)	<b>K13-2135</b>
---------------------------------	-----------------



*Includes: 5/8" Silver Sealing Washers (2)*

#### Shaft Seals

Lip Seal (Fat Shaft)	Nitrile <b>S13-1004</b>
Lip Seal (Fat Shaft)	Green HNBR <b>K13-3128</b>



*Includes: Lip Seal Retaining Ring (1), Lip Seal O-Ring (1), Lip Seal (1)*

#### Shipping Closures

Plug - Aluminum Dummy	<b>C13-2111</b>
Plug - Hollow Aluminum Dummy	<b>C13-2112</b>
Shipping Closure for Sealing Washer - 3/4" S / 5/8" D	<b>C13-5102</b>

#### Shipping Closures

Shipping Closure for Sealing Washer - 5/8" Ports	<b>C13-5101</b>
--	-----------------

#### Tools

Ceramic/Metal Shaft Seal Seat Remover / Installer	<b>T13-1037</b>
Clutch Plate Installer	<b>T13-3047</b>
Clutch Plate Remover	<b>LD22-121</b>
Clutch Plate Remover	<b>T13-3046</b>
Coil Installer	<b>LD22-292</b>
Piston Ring Expansion Cone (Requires T13-3010)	<b>T13-3048</b>
Piston Ring Installer	<b>T13-3010</b>
Shaft Seal Protector	<b>T13-1034</b>
Shaft Seal Protector (Early)	<b>T13-1036</b>
Shaft Seal Protector (Late)	<b>T13-1035</b>
Shaft Seal Protector, Adjustable	<b>T95-1228</b>
Shaft Seal Seat Installer / Remover (O.E.)	<b>T60-3001</b>



## GM/HARRISON

R4

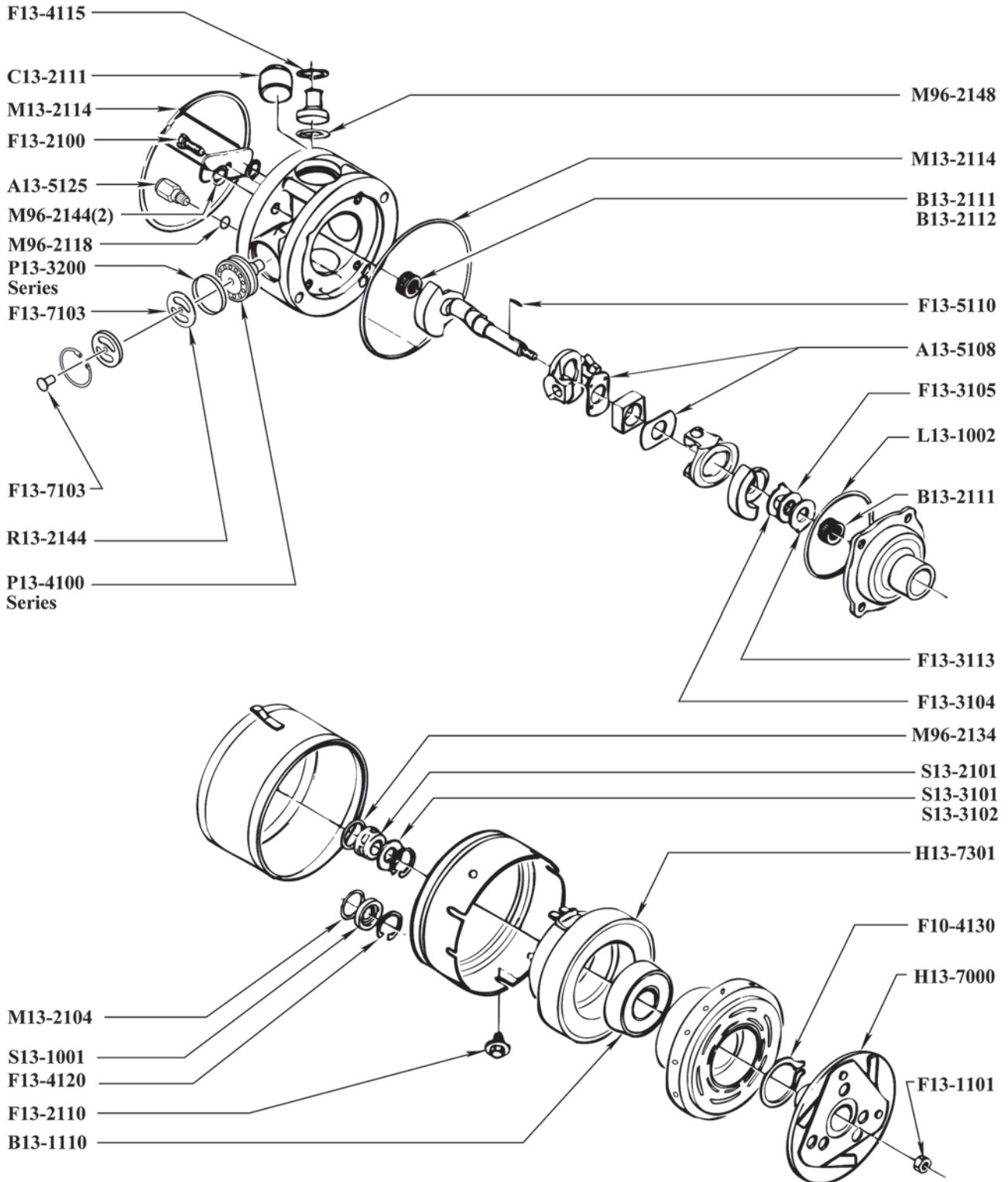

## GM/HARRISON

### R4

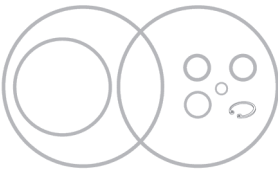
O-Rings and Lathe Cuts	R134a and R-12 Compatible	Green HNBR	Black Nitrile
Carbon Shaft Seal O-Ring		<b>M96-2134</b>	<b>M96-1034</b>
Case O-Ring		<b>M13-2114</b>	<b>M13-1014</b>
High Pressure Relief Valve O-Ring		<b>M96-2118</b>	<b>M96-1018</b>
Nose Piece Lathe Cut Seal			<b>L13-1002</b>
Shaft Seal Seat O-Ring		<b>M13-2104</b>	<b>M13-1004</b>
Suction / Discharge Port O-Ring		<b>M96-2144</b>	<b>M96-1044</b>
Suction / Discharge Port O-Ring (Optional)		<b>M11-2101</b>	<b>M11-1001</b>
Suction / Discharge Port Oval O-Ring		<b>A13-1110</b>	
Switch Port O-Ring		<b>M96-2148</b>	<b>M96-1048</b>
<b>Bearings</b>		<b>Fasteners</b>	
Case Bearing (19mm x 26.2mm x 12.5mm) (Pre 1992)	<b>B13-2111</b>	Bolt - Shipping Plate	<b>F13-2100</b>
Clutch Bearing (40mm x 62mm x 20.6mm)	<b>B13-1110</b>	Bolt - Shipping Plate (For C13-4100)	<b>F13-2153</b>
Thrust Bearing (Needles)	<b>B13-3115</b>	Helical Insert - Manifold Bolt (10-1.5mm x 15mm)	<b>F10-6218</b>
<b>Chemicals</b>		Helical Insert - Manifold Bolt (10-1.5mm x 20mm)	<b>F10-6217</b>
Ultra PAG Oil 150 - 6pk, 8 oz Bottle	<b>MT3014</b>	Locknut - Clutch Hub (Flanged)	<b>F13-1101</b>
Ultra PAG Oil 150 - 6pk, Quart Bottle	<b>MT3020</b>	Rivet - Piston (For P13-4100)	<b>F13-7101</b>
Ultra PAG Oil 150 - Drum (52 gal)	<b>A10-6165</b>	Rivet - Valve Plate	<b>F13-7103</b>
<b>Clutch Components</b>		Shaft Key	<b>F13-5110</b>
Clutch Coil w/ Pin - Tan Band (Angled Connector)	<b>H13-7301</b>	Spring Pin (3/4") - Crank	<b>F13-7110</b>
Clutch Hub - Short Shaft (Steel)	<b>H13-7000</b>	Spring Pin (9/16") - Crank	<b>F13-7111</b>
<b>Electrical</b>		Retaining Ring - Pulley	<b>F10-4130</b>
Clutch Coil Connector (Spade)	<b>E13-4000</b>	Retaining Ring - Shaft Seal Seat (Beveled)	<b>F13-4120</b>
Clutch Coil Extender - 12"	<b>E13-3000</b>	Retaining Ring - Switch Port	<b>F13-4115</b>
GM High Pressure Switch Connector	<b>E13-4003</b>	Washer - Belleville	<b>F13-3105</b>
GM Low Pressure Switch Connector	<b>E13-4002</b>	Washer - Tab	<b>F13-3104</b>
Straight Pigtail (Male 8mm Pin, with Diode)	<b>E13-4001</b>	Washer - Tang (Thick) (Late Model)	<b>F13-3113</b>
Straight Pigtail Adapter (Male 8mm Pin to Female Flat Spade)	<b>E13-3002</b>	<b>Gaskets</b>	
Straight Pigtail Adapter (Male Flat Spade to Female 8mm Pin)	<b>E13-3001</b>	O-Ring Kit	Green HNBR <b>K13-2110</b>
Condenser Fan Pressure Switch (Purple)	<b>E13-1011</b>		
Hi Side Low Pressure Cut-Off Switch (Black)	<b>E13-1018</b>		
Hi Side Low Pressure Cut-Off Switch (Brown)	<b>E13-1012</b>	<p><i>Includes: Case O-Ring (2), Switch Port Retaining Ring (1), Nose Piece Lathe Cut Seal (1), Switch Port O-Ring (1), Suction / Discharge Port O-Ring (2), Pressure Relief Valve O-Ring (1).</i></p>	
High Pressure Cut-Off Switch (Lt Blue)	<b>E13-1009</b>		
High Pressure Cut-Off Switch Kit	<b>E13-1022</b>		
Low Pressure Cut-Off Switch Kit	<b>E13-1019</b>		
Radiator Fan Pressure Switch (Gray)	<b>E13-1017</b>		
Radiator Fan Pressure Switch Kit	<b>E13-1016</b>		
<b>Fasteners</b>			
Bolt - Adapter Block	<b>F13-2111</b>		
Bolt - Mounting (65mm)	<b>F13-2152</b>		

## GM/HARRISON

R4

### Gaskets

O-Ring Kit

Black Nitrile **K13-2010**

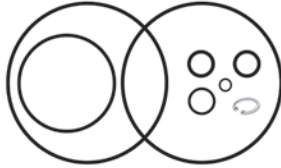

*Includes: Case O-Ring (2), Switch Port Retaining Ring (1), Nose Piece Lathe Cut Seal (1), Switch Port O-Ring (1), Suction / Discharge Port O-Ring (2), Pressure Relief Valve O-Ring (1).*

### Piston Components

Piston (11 Cu In) w/ Reed (Screw - use P13-5102) **P13-4103**

Piston (11 Cu In) w/o Reed (Screw - use P13-5102) **P13-4105**

Piston Ring (0.940mm) (Oversize) **P13-3237**

Piston Ring (2.032mm) (Use with New Style Piston) **P13-3280**

Slider Plate **A13-5108**

### Reeds and Valve Plates

Reed - Discharge Valve w/ Indicator **R13-2144**

### Service Items

High Pressure Relief Valve **A13-5125**

15mm-Slim-Line Sealing Washer (#10) **A13-1137**

Adapter Block **A13-1138**

Sealing Washer - 3/4" Silver (Thin) **A13-1123**

Sealing Washer - 5/8" Black (Thick) **A13-1122**

Sealing Washer - 5/8" Green (Thick) **A13-1126**

Sealing Washer - 5/8" Red (Thick) **A13-1127**

Sealing Washer - 5/8" Silver (Thin) **A13-1124**

Sealing Washer - 5/8" Yellow (Thick) **A13-1128**

Sealing Washer Pilot (Long) **A13-5109**

Sealing Washer Pilot (Short) **A13-5110**

Adapter Kit **K13-5104**



*Includes: 5/8" Thick Sealing Washer (Black) (1), 3/4" Thin Sealing Washer (Silver) (1), 5/8" Thin Sealing Washer (Silver) (1), 5/8" Thick Sealing Washer (Red) (1), 5/8" Thick Sealing Washer (Yellow) (1), Adapter Block (1), Block Bolt (1)*

### Service Items

Sealing Washer Kit

**K13-2101**



*Includes: 5/8" Thick GM Sealing Washer (Black) (2), Manifold Pilot Washer Insert (2).*

Sealing Washer Kit - 1992 and Up

**K13-2102**



*Includes: 5/8" (Thin) Sealing Washer (1), 3/4" Sealing Washer (1)*

Sealing Washer Kit (Single Use)

**K13-2127**



*Includes: 3/4" Thin (Silver) (2), 5/8" Thin (Silver) (2), 5/8" Thick (Green) (1), 5/8" Thick (Red) (1), 5/8" Thick (Yellow) (1), Pilot (Long) (1), Pilot (Short) (1)*

Sealing Washer Kit (Single Use)

**K13-2135**



*Includes: 5/8" Silver Sealing Washers (2)*

### Shaft Seals

Carbon Shaft Seal **HNBR S13-2101**

Ceramic Shaft Seal Seat **S13-3101**

Felt Wiper - Wick Type **S13-4101**

Felt Wiper Retainer **S13-6101**

Lip Seal (Double) **Nitrile S13-1002**

Lip Seal (Single) (O.E.) **Nitrile S13-1001**

Metal Shaft Seal Seat **S13-3102**

## GM/HARRISON

### R4

#### Shaft Seals

Carbon Shaft Seal Kit Green HNBR **K13-3110**



*Includes: Shaft Seal Seat Retaining Ring (Beveled) (1), Carbon Shaft Seal (1), Metal Shaft Seal Seat (1), Shaft Seal Seat O-Ring (1)*

Carbon Shaft Seal Kit Green HNBR **K13-3120**  
(Ceramic)



*Includes: Shaft Seal Seat Retaining Ring (Beveled) (1), Carbon Shaft Seal (1), Ceramic Shaft Seal Seat (1), Shaft Seal Seat O-Ring (1)*

Lip Seal Kit (Single Lip Seal) Green HNBR **K13-3125**



*Includes: Lip Seal Retaining Ring (1), Lip Seal O-Ring (1), Lip Seal (1)*

#### Shipping Closures

Plug - Aluminum Dummy **C13-2111**

Shipping Closure for O-Rings **C13-5100**

Shipping Closure for Sealing Washer - 3/4" S / **C13-5102**  
5/8" D

Shipping Closure for Sealing Washer - 5/8" **C13-5101**  
Ports

Shipping Closure for Sealing Washer - 5/8" S / **C13-5103**  
3/4" D

Shipping Pad (Use with C13-4100 or C13- **C13-3000**  
4101)

Shipping Plate (Rectangular) (Use with 2 C13- **C13-4100**  
3000)

Shipping Plate (Rounded) (Use with 2 C13- **C13-4101**  
3000)

#### Tools

Ceramic/Metal Shaft Seal Seat Remover / **T13-1037**  
Installer

Clutch Plate Installer **T13-3041**

#### Tools

Clutch Plate Remover **T13-3042**

Clutch Plate Remover Arbor **LD99-1195**

Half Moon Drive Piston Installer / Remover **T13-3052**

O-Ring Installation Tool **LD99-460**

Piston Ring Expansion Cone (Requires T13- **T13-3009**  
3010)

Piston Ring Installer **T13-3010**

Shaft Seal Protector **T13-1035**

Shaft Seal Protector, Adjustable **T95-1228**

Shaft Seal Seat Installer / Remover (O.E.) **T60-3001**

## GM/HARRISON

### V5, V5 (CITREON), V5 (DESTROKER)

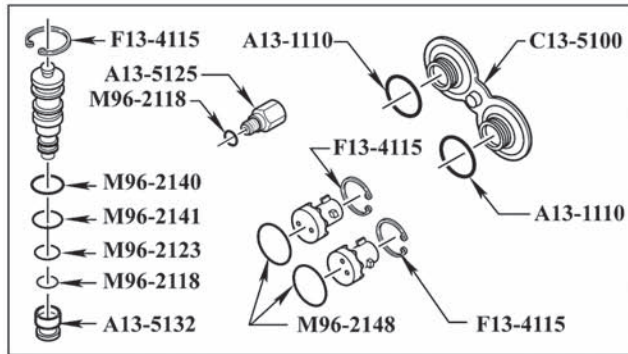

See Detail For Part Number Information on Rear Head O-Rings, Switches, Fasteners, & Closures

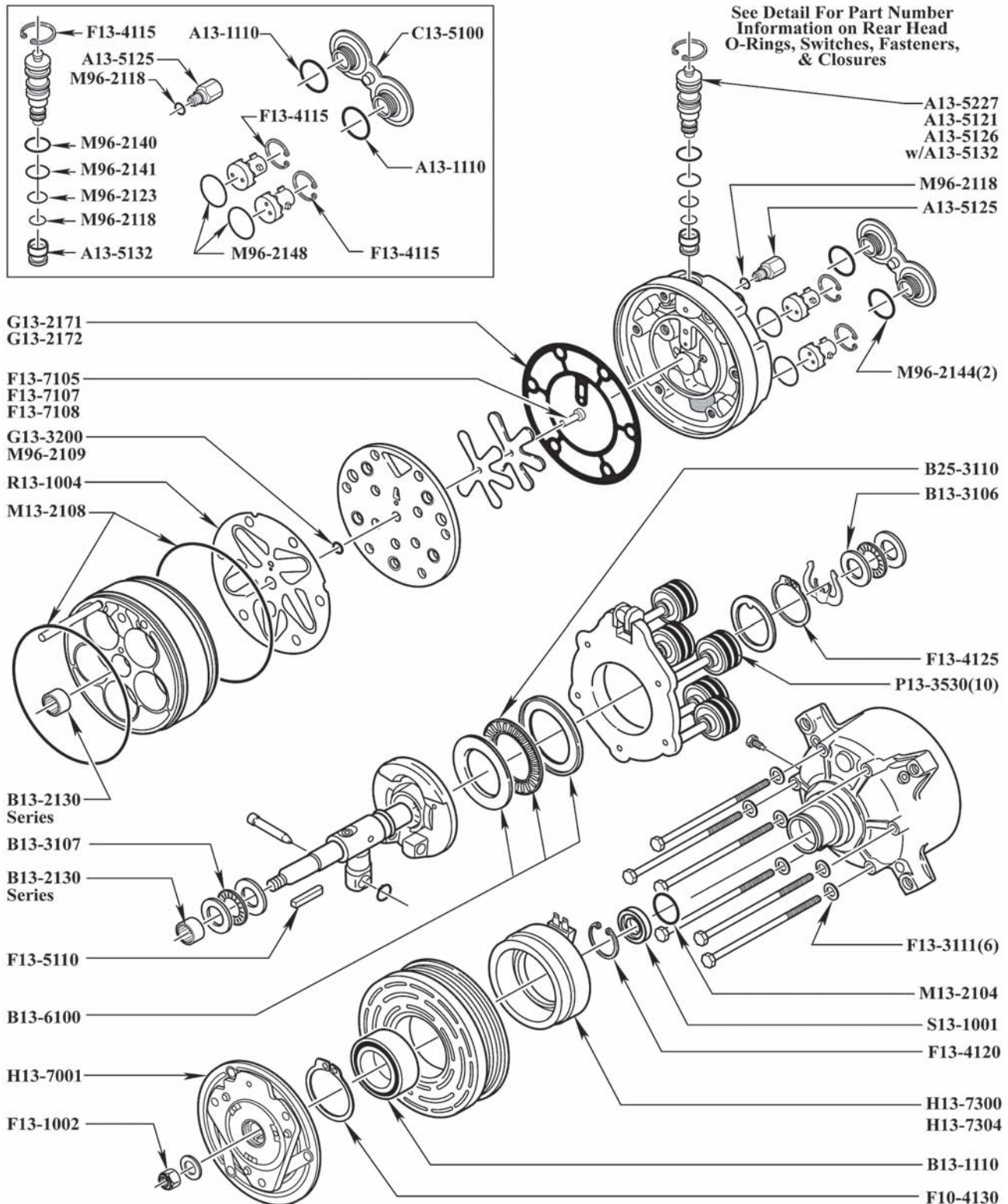



## GM/HARRISON

### V5, V5 (CITREON), V5 (DESTROKER)

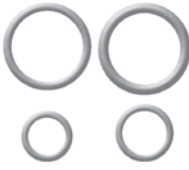
O-Rings	R134a and R-12 Compatible	Green HNBR	Black Nitrile
Case O-Ring		<b>M13-2108</b>	<b>M13-1008</b>
Control Valve (Inner) / High PSI Relief Valve O-Ring		<b>M96-2118</b>	<b>M96-1018</b>
Control Valve O-Ring (Inside Center)		<b>M96-2123</b>	<b>M96-1023</b>
Control Valve O-Ring (Outside Center)		<b>M96-2141</b>	<b>M96-1041</b>
Control Valve O-Ring (Outside)		<b>M96-2140</b>	<b>M96-1040</b>
Destroyer Valve Plate O-Ring (Older Model)		<b>M96-2109</b>	<b>M96-1009</b>
Lip Seal O-Ring		<b>M13-2104</b>	<b>M13-1004</b>
Suction / Discharge Port O-Ring		<b>M96-2144</b>	<b>M96-1044</b>
Suction / Discharge Port Oval O-Ring		<b>A13-1110</b>	
Switch Port O-Ring		<b>M96-2148</b>	<b>M96-1048</b>
<b>Bearings</b>		<b>Control Valves</b>	
Case Bearing (14.3mm x 20.6mm x 15.7mm)	<b>B13-2133</b>	Control Valve Screen	<b>A13-5132</b>
Case Bearing (15.9mm x 21.3mm x 12.7mm)	<b>B13-2132</b>	O-Ring Kit, Control Valve (4 O-Rings)	Green HNBR <b>K13-2122</b>
Case Bearing (15.9mm x 21mm x 12.5mm)	<b>B13-2130</b>	 <p><i>Includes: Control Valve O-Ring (Inside) (1), Control Valve O-Ring (Inside Center) (1), Control Valve O-Ring (Outside) (1), Control Valve O-Ring (Outside Center) (1)</i></p>	
Clutch Bearing (40mm x 62mm x 20.6mm)	<b>B13-1110</b>		
Thrust Bearing (16mm x 33mm x 4mm)	<b>B13-3107</b>		
Thrust Bearing (16mm x 35mm x 4.8mm)	<b>B13-3106</b>		
Thrust Bearing (57.2mm x 79.4mm x 3.2mm)	<b>B25-3110</b>		
Thrust Bearing Set	<b>B13-6100</b>	<b>Electrical</b>	
<b>Chemicals</b>		Clutch Coil Connector (Spade)	<b>E13-4000</b>
Ultra PAG Oil 150 - 6pk, 8 oz Bottle	<b>MT3014</b>	Clutch Coil Extender - 12"	<b>E13-3000</b>
Ultra PAG Oil 150 - 6pk, Quart Bottle	<b>MT3020</b>	GM High Pressure Switch Connector	<b>E13-4003</b>
Ultra PAG Oil 150 - Drum (52 gal)	<b>A10-6165</b>	GM Low Pressure Switch Connector	<b>E13-4002</b>
<b>Clutch Components</b>		Straight Pigtail (Male 8mm Pin, with Diode)	<b>E13-4001</b>
Clutch Hub - OD: 112mm, Offset 25.3mm	<b>H13-7006</b>	Straight Pigtail Adapter (Male 8mm Pin to Female Flat Spade)	<b>E13-3002</b>
Clutch Coil - OD/ID: 101.9mm / 51.5mm (Fixed Conn) (Daewoo)	<b>H13-7319</b>	Straight Pigtail Adapter (Male Flat Spade to Female 8mm Pin)	<b>E13-3001</b>
Clutch Coil - OD/ID: 103mm / 72mm (Fixed Connector)	<b>H13-7303</b>	Condenser Fan Pressure Switch (Purple)	<b>E13-1011</b>
Clutch Coil - OD/ID: 103mm / 72mm (Pigtail)	<b>H13-7315</b>	Hi Side Low Pressure Cut-Off Switch (Black)	<b>E13-1018</b>
Clutch Coil - OD/ID: 103mm / 72mm (Wire Harness)	<b>H13-7312</b>	Hi Side Low Pressure Cut-Off Switch (Brown)	<b>E13-1012</b>
Clutch Coil - OD/ID: 92.7mm / 71.5mm	<b>H13-7313</b>	High Pressure Cut-Off Switch (Lt Blue)	<b>E13-1009</b>
Clutch Coil w/ Pin - Black Band (Straight Connector)	<b>H13-7300</b>	High Pressure Cut-Off Switch Kit	<b>E13-1022</b>
Clutch Coil w/Spade - Blue Band	<b>H13-7304</b>	Low Pressure Cut-Off Switch Kit	<b>E13-1019</b>
Clutch Hub - Arrowhead Style	<b>H13-7001</b>	Radiator Fan Pressure Switch (Gray)	<b>E13-1017</b>
Clutch Pulley - 6 Groove w/o Bearing (129.5mm)	<b>H13-7710</b>	Radiator Fan Pressure Switch Kit	<b>E13-1016</b>
<b>Control Valves</b>		<b>Fasteners</b>	
Control Valve (R12) (Requires A13-5132)	<b>A13-5121</b>	Bolt - Adapter Block	<b>F13-2111</b>
Control Valve (R134a)	<b>A13-5227</b>	Bolt - Shipping Plate (For C13-4100)	<b>F13-2153</b>
Control Valve (R134a)	<b>A13-5230</b>	Locknut - Clutch Hub	<b>F13-1002</b>
Control Valve (R134a) (Requires A13-5132)	<b>A13-5126</b>		

## GM/HARRISON

### V5, V5 (CITREON), V5 (DESTROKER)

#### Fasteners

Rivet - Valve Plate	<b>F13-7105</b>
Rivet (w/ Hole) - Valve Plate (Destroyer)	<b>F13-7108</b>
Rivet (w/out Hole) - Valve Plate (Destroyer)	<b>F13-7107</b>
Shaft Key	<b>F13-5110</b>
Retaining Ring - Control Valve / Switch Port	<b>F13-4115</b>
Retaining Ring - Lip Seal	<b>F25-4111</b>
Retaining Ring - Lip Seal (Beveled)	<b>F13-4120</b>
Retaining Ring - Piston Rotator (Beveled)	<b>F13-4125</b>
Retaining Ring - Pulley	<b>F10-4130</b>
Washer - Head Bolt	<b>F13-3111</b>

#### Gaskets

Gasket - Head (6.8mm x 7.7mm Oval Bolt Hole) (92 & Earlier)	Metal <b>G13-2171</b>
Gasket - Head (8.0mm x 8.3mm Oval Bolt Hole) (93 & Later)	Metal <b>G13-2172</b>
Gasket Kit (Metal) (6.8mm x 7.7mm Oval Bolt Hole)	Green HNBR <b>K13-2120</b>

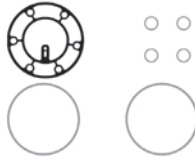

Includes: Head Gasket (Metal) (6.8 mm x 7.7 mm Oval Bolt Hole) (1), Switch Port O-Ring (2), Case O-Ring (2), Suction / Discharge Port O-Ring (2)

Gasket Kit (Metal) (8.0mm x 8.3mm Oval Bolt Hole)	Green HNBR <b>K13-2121</b>
---	----------------------------

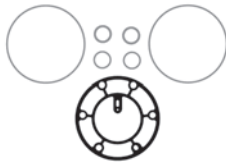

Includes: Head Gasket (Metal) (8.0 mm x 8.3 mm Oval Bolt Hole) (1), Switch Port O-Ring (2), Case O-Ring (2), Suction / Discharge Port O-Ring (2)

#### Gaskets

Gasket Kit (Metal) (6.8mm x 7.7mm Oval Bolt Hole)	Black Nitrile <b>K13-2020</b>
---	-------------------------------

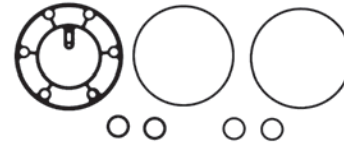

Includes: Head Gasket (Metal) (6.8 mm x 7.7 mm Oval Bolt Hole) (1), Switch Port O-Ring (2), Case O-Ring (2), Suction / Discharge Port O-Ring (2)

V5 Metal Gasket Kit 1993 and Later	Black Nitrile <b>K13-2023</b>
------------------------------------	-------------------------------

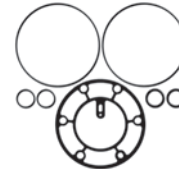

Includes: Valve Plate Gaskets -1993 and Later - Metal (1), Case O-ring (2), Suction / Discharge O-ring (2), Switch Port O-ring (2)

#### Piston Components

Piston Ring (0.76mm) (Standard)	<b>P13-3530</b>
---------------------------------	-----------------

#### Reeds and Valve Plates

Reed - Suction Valve	<b>R13-1004</b>
----------------------	-----------------

#### Service Items

High Pressure Relief Valve	<b>A13-5125</b>
15mm-Slim-Line Sealing Washer (#10)	<b>A13-1137</b>
Adapter Block	<b>A13-1138</b>
Sealing Washer - 3/4" Silver (Thin)	<b>A13-1123</b>
Sealing Washer - 5/8" Black (Thick)	<b>A13-1122</b>
Sealing Washer - 5/8" Green (Thick)	<b>A13-1126</b>
Sealing Washer - 5/8" Red (Thick)	<b>A13-1127</b>
Sealing Washer - 5/8" Silver (Thin)	<b>A13-1124</b>
Sealing Washer - 5/8" Yellow (Thick)	<b>A13-1128</b>
Sealing Washer Pilot (Long)	<b>A13-5109</b>
Sealing Washer Pilot (Short)	<b>A13-5110</b>

## GM/HARRISON

### V5, V5 (CITREON), V5 (DESTROKER)

#### Service Items

Adapter Kit

**K13-5104**



*Includes: 5/8" Thick Sealing Washer (Black) (1), 3/4" Thin Sealing Washer (Silver) (1), 5/8" Thin Sealing Washer (Silver) (1), 5/8" Thick Sealing Washer (Red) (1), 5/8" Thick Sealing Washer (Yellow) (1), Adapter Block (1), Block Bolt (1)*

Sealing Washer Kit (Single Use)

**K13-2125**



*Includes: 5/8" Thick (Black) (2), 3/4" Thin (Silver) (1), 5/8" Thin (Silver) (2), 5/8" Thick (Green) (1), 5/8" Thick (Red) (1), 5/8" Thick (Yellow) (1), Pilot (Long) (1), Pilot (Short) (1)*

Sealing Washer Kit (Single Use)

**K13-2135**



*Includes: 5/8" Silver Sealing Washers (2)*

#### Shaft Seals

Lip Seal (Black Rubber Coated)

Nitrile **S13-1005**

Lip Seal (Black Rubber Coated)

HNBR **S30-1110**

Lip Seal (Double)

Nitrile **S13-1002**

Lip Seal (Single) (O.E.)

Nitrile **S13-1001**

Lip Seal Kit (Single Lip Seal)

Green HNBR **K13-3125**



*Includes: Lip Seal Retaining Ring (1), Lip Seal O-Ring (1), Lip Seal (1)*

#### Shaft Seals

Lip Seal Kit, Rubber Coated

Green HNBR **K13-3130**



*Includes: Lip Seal Retaining Ring (1), Lip Seal (1)*

#### Shipping Closures

Plug - Aluminum Dummy

**C13-2111**

Shipping Closure for O-Rings

**C13-5100**

Shipping Closure for Sealing Washer - 3/4" S / 5/8" D

**C13-5102**

Shipping Closure for Sealing Washer - 5/8" Ports

**C13-5101**

Shipping Closure for Sealing Washer - 5/8" S / 3/4" D

**C13-5103**

Shipping Pad (Use with C13-4100)

**C13-3000**

Shipping Plate (Rectangular) (Use with 2 C13-3000)

**C13-4100**

#### Tools

Clutch Plate Installer

**T13-3047**

Clutch Plate Remover

**LD22-121**

Clutch Plate Remover

**T13-3046**

Coil Installer

**LD22-292**

Piston Ring Expansion Cone (Requires T13-3010)

**T13-3051**

Piston Ring Installer

**T13-3010**

Piston Ring Sizing Tool

**T13-3050**

Shaft Seal Protector

**T13-1035**

Shaft Seal Protector, Adjustable

**T95-1228**

Shaft Seal Seat Installer / Remover (O.E.)

**T60-3001**

## GM/HARRISON

### V7, V7 (DESTROKER)

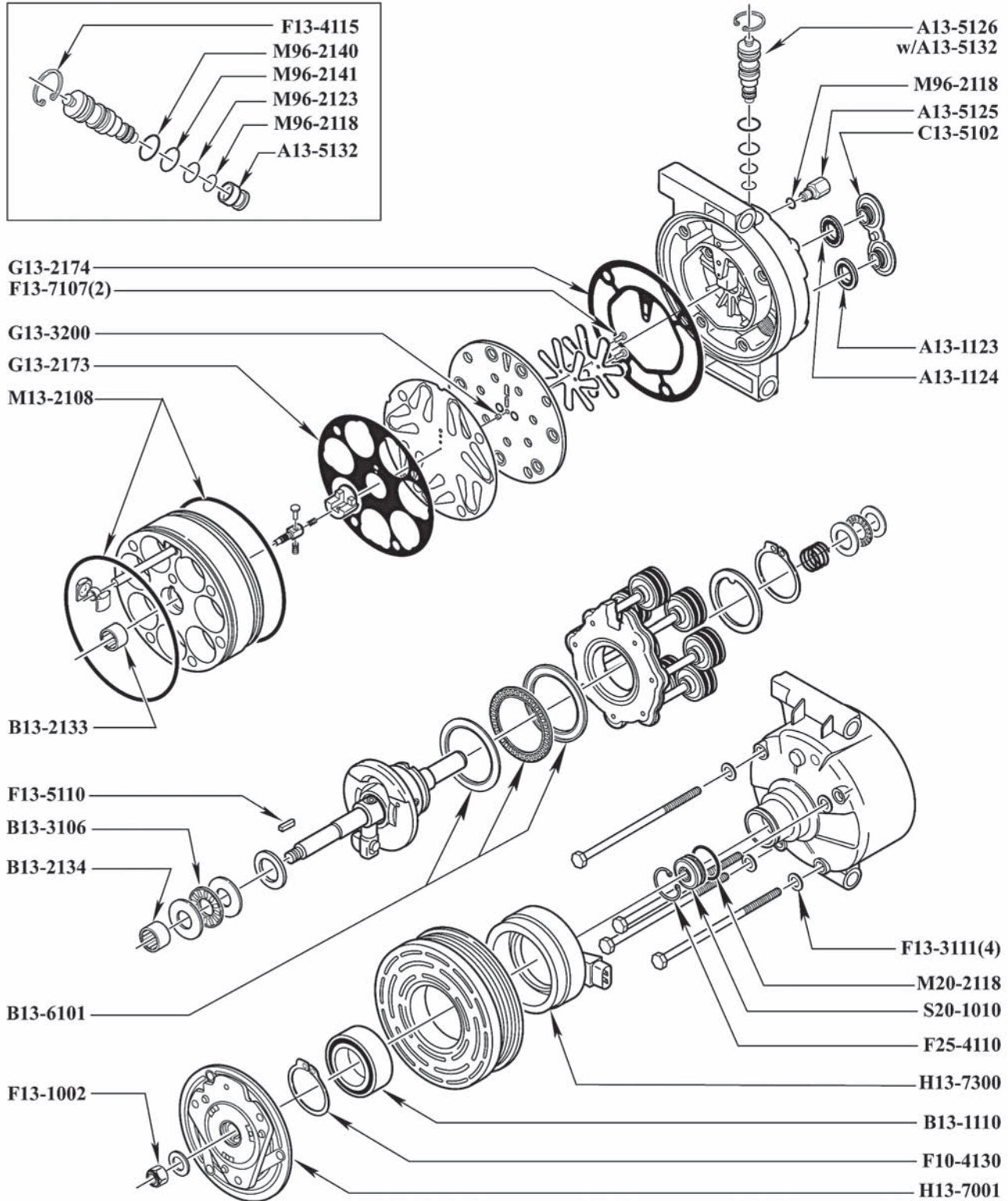

## GM/HARRISON

### V7, V7 (DESTROKER)

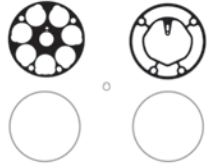
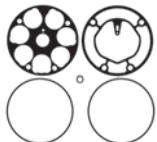
O-Rings	R134a and R-12 Compatible	Green HNBR	Black Nitrile
Case O-Ring		<b>M13-2108</b>	<b>M13-1008</b>
Control Valve (Inner) / High PSI Relief Valve O-Ring		<b>M96-2118</b>	<b>M96-1018</b>
Control Valve O-Ring (Inside Center)		<b>M96-2123</b>	<b>M96-1023</b>
Control Valve O-Ring (Outside Center)		<b>M96-2141</b>	<b>M96-1041</b>
Control Valve O-Ring (Outside)		<b>M96-2140</b>	<b>M96-1040</b>
Lip Seal O-Ring		<b>M20-2118</b>	<b>M20-1018</b>
<b>Bearings</b>		<b>Electrical</b>	
Case Bearing (Front) (15.9mm x 22.3mm x 15.8mm)	<b>B13-2134</b>	Low Pressure Cut-Off Switch Kit	<b>E13-1019</b>
Case Bearing (Rear) (14.3mm x 20.6mm x 15.7mm)	<b>B13-2133</b>	Radiator Fan Pressure Switch (Gray)	<b>E13-1017</b>
Clutch Bearing (40mm x 62mm x 20.6mm)	<b>B13-1110</b>	Radiator Fan Pressure Switch Kit	<b>E13-1016</b>
Thrust Bearing (Front) (16mm x 35mm x 4.8mm)	<b>B13-3106</b>	<b>Fasteners</b>	
Thrust Bearing Set	<b>B13-6101</b>	Locknut - Clutch Hub	<b>F13-1002</b>
<b>Chemicals</b>		Rivet - Valve Plate	<b>F13-7107</b>
Ultra PAG Oil 150 - 6pk, 8 oz Bottle	<b>MT3014</b>	Shaft Key	<b>F13-5110</b>
Ultra PAG Oil 150 - 6pk, Quart Bottle	<b>MT3020</b>	Retaining Ring - Control Valve	<b>F13-4115</b>
Ultra PAG Oil 150 - Drum (52 gal)	<b>A10-6165</b>	Retaining Ring - Pulley	<b>F10-4130</b>
<b>Clutch Components</b>		Retaining Ring (Beveled) - Lip Seal	<b>F25-4110</b>
Clutch Coil w/ Pin - Black Band (Straight Connector)	<b>H13-7300</b>	Retaining Ring (Beveled) - Lip Seal	<b>F25-4111</b>
Clutch Hub - Arrowhead Style	<b>H13-7001</b>	Washer - Head Bolt	<b>F13-3111</b>
<b>Control Valves</b>		<b>Gaskets</b>	
Control Valve (R134a) (Requires A13-5132)	<b>A13-5126</b>	Gasket - Cylinder	Metal <b>G13-2173</b>
Control Valve Screen	<b>A13-5132</b>	Gasket - Front Head	Metal <b>G13-2174</b>
O-Ring Kit, Control Valve	Green HNBR <b>K13-2122</b>	Seal - Destroyer Valve Plate	Black Neoprene <b>G13-3200</b>
		Gasket Kit (Metal)	Green HNBR <b>K13-2130</b>
			
<p><i>Includes: Control Valve O-Ring (Inside) (1), Control Valve O-Ring (Inside Center) (1), Control Valve O-Ring (Outside) (1), Control Valve O-Ring (Outside Center) (1)</i></p>		<p><i>Includes: Cylinder Gasket(Metal) (1), Head Gasket(Metal) (1), Front &amp; Rear Case O-Rings (2), High pressure Relief Valve O-Rings (1).</i></p>	
<b>Electrical</b>		<b>Gasket Kit (Metal)</b>	
GM High Pressure Switch Connector	<b>E13-4003</b>	Black Nitrile <b>K13-2030</b>	
GM Low Pressure Switch Connector	<b>E13-4002</b>		
Condenser Fan Pressure Switch (Purple)	<b>E13-1011</b>	<p><i>Includes: Front Head Gasket (1), Rear Head Gasket (1), Case O-Ring (2), Pressure Relief Valve O-Ring (1).</i></p>	
Hi Side Low Pressure Cut-Off Switch (Black)	<b>E13-1018</b>	<b>Service Items</b>	
Hi Side Low Pressure Cut-Off Switch (Brown)	<b>E13-1012</b>	High Pressure Relief Valve	<b>A13-5125</b>
High Pressure Cut-Off Switch (Lt Blue)	<b>E13-1009</b>	15mm-Slim-Line Sealing Washer (#10)	<b>A13-1137</b>
High Pressure Cut-Off Switch Kit	<b>E13-1022</b>		

## GM/HARRISON

### V7, V7 (DESTROKER)

#### Service Items

Adapter Block	<b>A13-1138</b>
Sealing Washer - 3/4" Silver (Thin)	<b>A13-1123</b>
Sealing Washer - 5/8" Black (Thick)	<b>A13-1122</b>
Sealing Washer - 5/8" Green (Thick)	<b>A13-1126</b>
Sealing Washer - 5/8" Red (Thick)	<b>A13-1127</b>
Sealing Washer - 5/8" Silver (Thin)	<b>A13-1124</b>
Sealing Washer - 5/8" Yellow (Thick)	<b>A13-1128</b>
Sealing Washer Pilot (Long)	<b>A13-5109</b>
Sealing Washer Pilot (Short)	<b>A13-5110</b>
Sealing Washer Kit (Single Use)	<b>K13-2135</b>

#### Tools

Shaft Seal Protector	<b>T13-1035</b>
Shaft Seal Protector, Adjustable	<b>T95-1228</b>



Includes: 5/8" Silver Sealing Washers (2)

#### Shaft Seals

Lip Seal (Black Rubber Coated)	Nitrile <b>S13-1005</b>
Lip Seal (Black Rubber Coated)	HNBR <b>S30-1110</b>
Lip Seal (Triple)	Nitrile <b>S20-1010</b>
Lip Seal Kit	Green HNBR <b>K13-3127</b>



Includes: Shaft Seal Retaining Ring (1), Lip Seal (1), Lip Seal O-Ring (1).

Lip Seal Kit	Green HNBR <b>K13-3129</b>
--------------	----------------------------



Includes: Lip Seal Retaining Ring (1), Lip Seal (1)

#### Shipping Closures

Shipping Closure for Sealing Washer - 3/4" S / 5/8" D	<b>C13-5102</b>
---	-----------------



## GM/HARRISON

### VIR

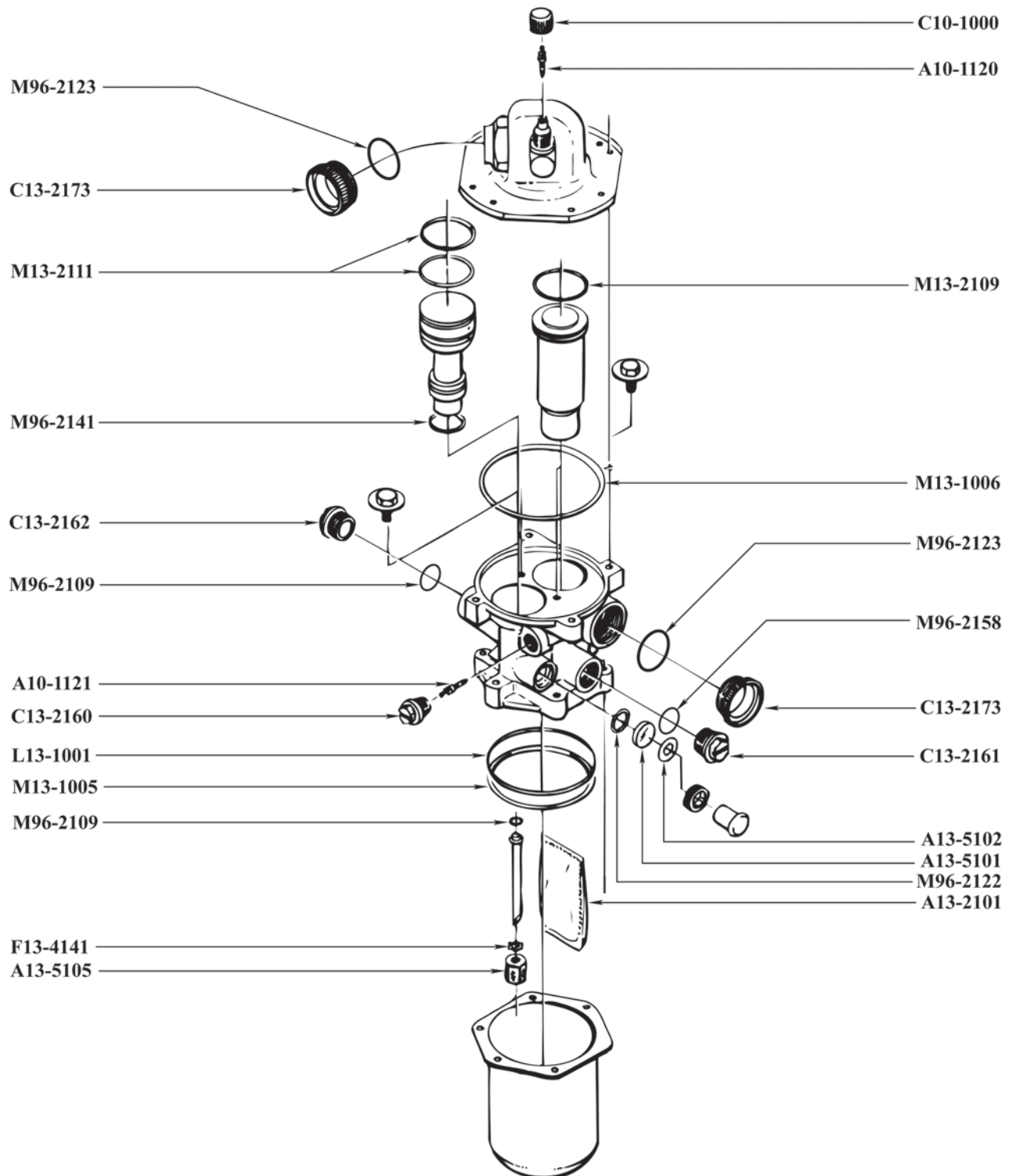



## GM/HARRISON

### VIR

O-Rings and Lathe Cuts	R134a and R-12 Compatible	Green HNBR	Black Nitrile
Condenser Line O-Ring / Pickup Tube O-Ring		<b>M96-2109</b>	<b>M96-1009</b>
Evaporator Inlet Line Connection O-Ring		<b>M96-2123</b>	<b>M96-1023</b>
Expansion Valve O-Ring (Lower)		<b>M96-2141</b>	<b>M96-1041</b>
Expansion Valve O-Ring (Upper & Center)		<b>M13-2111</b>	<b>M13-1011</b>
Housing to Receiver Shell Lathe Cut Seal (Upper)			<b>L13-1001</b>
Housing to Receiver Shell O-Ring (Lower)			<b>M13-1005</b>
Inlet Connector Shell to Housing O-Ring			<b>M13-1006</b>
Liquid Bleed Line O-Ring		<b>M96-2158</b>	<b>M96-1058</b>
POA Valve O-Ring		<b>M13-2109</b>	<b>M13-1009</b>
Sightglass O-Ring		<b>M96-2122</b>	<b>M96-1022</b>

#### Fasteners

Retaining Ring - Pickup Tube **F13-4141**

#### Gaskets

Full Maintenance Kit **Green HNBR K13-2103**



*Includes: Valve Core - Low Pressure (1), Desiccant Bag (R134a Compatible) (1), Sightglass (1), Sightglass Gasket (1), Pick-up Tube Screen (1), Cap - 1/4" Low Side (1), Retaining Ring - Pickup Tube (1), Housing to Receiver Shell Lathe Cut Seal (Upper) (1),*

#### Shipping Closures

Plug - Accumulator (Evapor. Inlet / Outlet Connection) **C13-2173**

Plug - Bleed Valve **C13-2160**

Plug - Compressor Outlet Connection **C13-2162**

Plug - Liquid Bleed Line **C13-2161**

Shipping Cap - Accumulator Fitting **C13-1156**

Shipping Cap - Accumulator Outlet Fitting **C13-1152**

Shipping Cap - Accumulator Switch Port **C13-1153**

#### Maintenance Kit

**Black Nitrile K13-2002**

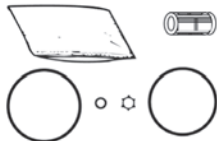

*Includes: Desiccant Bag (R134a Compatible) (1), Pickup Tube Screen (1), Pickup Tube Retainer (1), Housing to Receiver Shell Lathe Cut (Upper) (1), Condenser Line O-Ring / Pickup Tube O-Ring (1), Housing to Receiver Shell O-Ring (Lower) (1)*

#### Service Items

Valve Core - Low Pressure **A10-1121**

Valve Core - Standard Pressure **A10-1120**

Accumulator Desiccant Bag (R134a Compatible) **A13-2101**

Pick-up Tube Screen **A13-5105**

Sightglass **A13-5101**

Sightglass Gasket **A13-5102**

#### Shipping Closures

Cap - 1/4" Low Side **C10-1000**

## HADSYS RC17D, RC17S

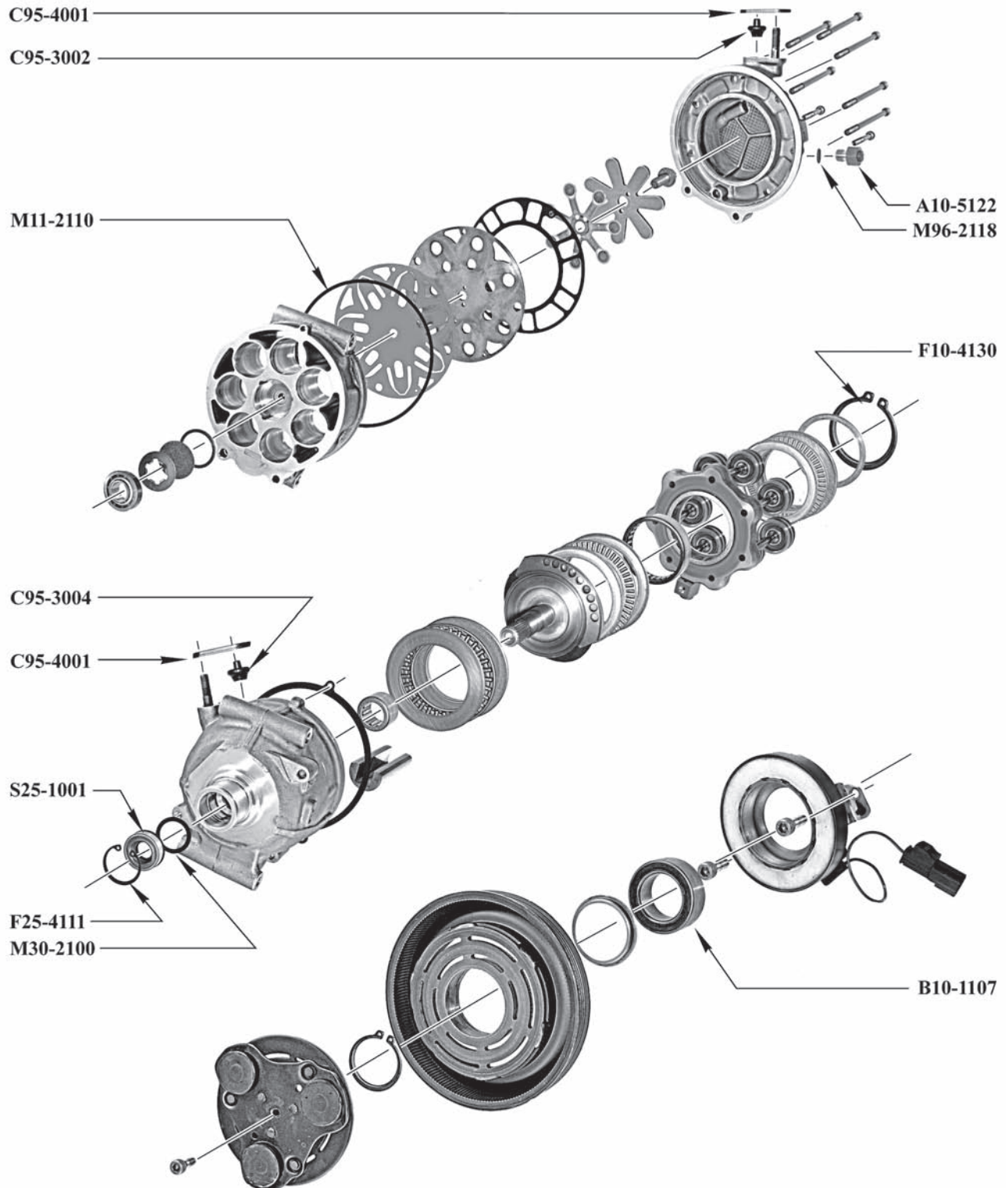

## HADSYS RC17D, RC17S

O-Rings	R134a and R-12 Compatible	Green HNBR	Black Nitrile
High Pressure Relief Valve O-Ring		<b>M96-2118</b>	<b>M96-1018</b>
Lip Seal O-Ring		<b>M30-2100</b>	<b>M30-1000</b>
<b>Bearings</b>			
Clutch Bearing (35mm x 55mm x 20mm)	<b>B10-1107</b>		
<b>Chemicals</b>			
Ultra PAG Oil 46 - 6pk, 8 oz Bottle	<b>MT3012</b>		
Ultra PAG Oil 46 - 6pk, Quart Bottle	<b>MT3018</b>		
Ultra PAG Oil 46 - Drum (52 gal)	<b>A10-6163</b>		
<b>Fasteners</b>			
Nut - Shipping Plate	<b>F11-1110</b>		
Retaining Ring - Lip Seal	<b>F25-4111</b>		
Retaining Ring, Small Rear Thrust Bearing	<b>F10-4130</b>		
<b>Service Items</b>			
High Pressure Relief Valve 3/8-24 w/Non-Captive O-Ring	<b>A10-5122</b>		
<b>Shaft Seals</b>			
Lip Seal	<b>HNBR S25-1001</b>		
Lip Seal Kit	<b>Green HNBR K95-3100</b>		



*Includes: Lip Seal Retaining Ring (1), Lip Seal (1)*

<b>Shipping Closures</b>	
Shipping Plate (Use with C95-3002 & C95-3004)	<b>C95-4001</b>
Shipping Plug (Discharge) (Use with C95-4001)	<b>C95-3002</b>
Shipping Plug (Suction) (Use with C95-4001)	<b>C95-3004</b>
<b>Tools</b>	
Shaft Seal Protector, Adjustable	<b>T95-1227</b>

## HITACHI

### A5000

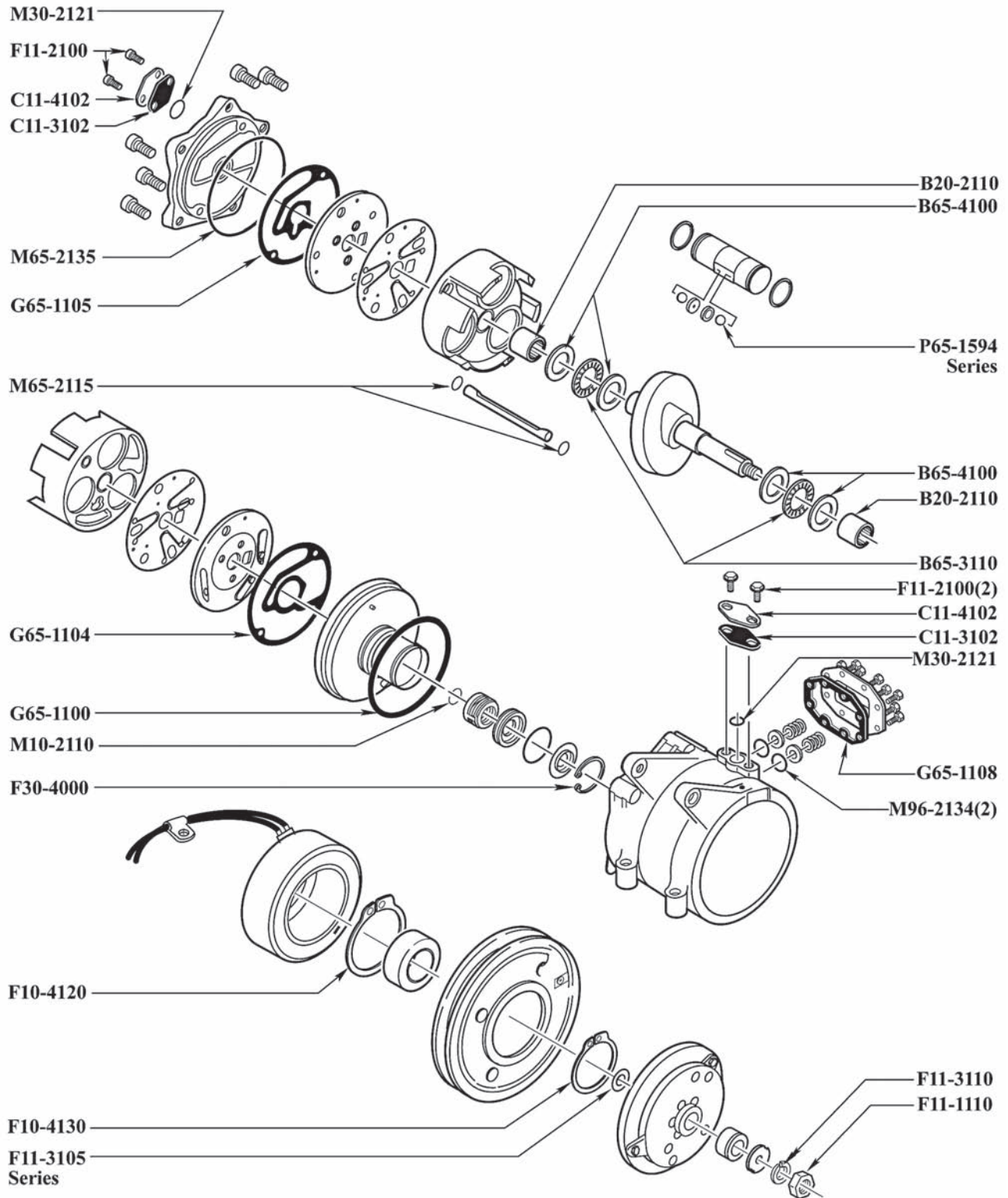

## HITACHI

### A5000

O-Rings	R134a and R-12 Compatible	Green HNBR	Black Nitrile
Carbon Shaft Seal O-Ring		<b>M10-2110</b>	<b>M10-1010</b>
Case O-Ring		<b>M65-2135</b>	<b>M65-1035</b>
Crossover O-Ring		<b>M96-2134</b>	<b>M96-1034</b>
Crossover Tube O-Ring		<b>M65-2115</b>	<b>M65-1015</b>
Suction/Discharge Port O-Ring		<b>M30-2121</b>	

Bearings	
Case Bearing (16mm x 23mm x 16mm)	<b>B20-2110</b>
Thrust Bearing (20.1mm x 34.7mm x 2mm)	<b>B65-3110</b>
Thrust Race (2.30mm)	<b>B65-4100</b>

Chemicals	
Ultra PAG Oil 46 - 6pk, 8 oz Bottle	<b>MT3012</b>
Ultra PAG Oil 46 - 6pk, Quart Bottle	<b>MT3018</b>
Ultra PAG Oil 46 - Drum (52 gal)	<b>A10-6163</b>

Fasteners	
Bolt - Shipping Plate	<b>F11-2100</b>
Helical Insert - Rear Head / Shipping Plate (8-1.25 x 12mm)	<b>F10-6211</b>
Nut - Shaft	<b>F11-1110</b>
Retaining Ring - Coil	<b>F10-4120</b>
Retaining Ring - Lip Seal	<b>F30-4000</b>
Retaining Ring - Pulley	<b>F10-4130</b>
Lockwasher - Shaft	<b>F11-3110</b>
Shim - Clutch (0.20mm)	<b>F11-3105</b>
Shim - Clutch (0.51mm)	<b>F11-3115</b>

Gaskets	
Gasket - Front Case	Fiber <b>G65-1100</b>
Gasket - Front Head	Fiber <b>G65-1104</b>
Gasket - Rear Head	Fiber <b>G65-1105</b>
Gasket - Side Plate	Fiber <b>G65-1108</b>
Gasket Kit (Fiber)	Black Nitrile <b>K65-2001</b>

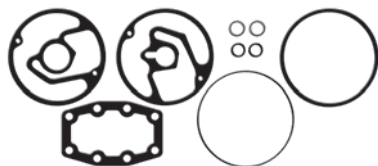

Includes: Front Case Gasket (1), Front Head Gasket (1), Rear Head Gasket (1), Side Plate Gasket (1), Crossover O-Ring (2), Case O-Ring (1), Vibration Damper O-Ring (2)

Piston Components	
Piston Ball (15.08mm)	<b>P65-1594</b>
Piston Ball (15.11mm)	<b>P65-1595</b>

Shaft Seals	
Lip Seal (Black Rubber Coated)	<b>HNBR S65-1100</b>

Shipping Closures	
Shipping Pad (Use with C11-4102)	<b>C11-3102</b>
Shipping Plate (Use with C11-3102)	<b>C11-4102</b>
Shipping Plate (Use with C95-3004 & C95-3006)	<b>C95-4001</b>
Shipping Plug (Discharge) (Use with C95-4001)	<b>C95-3004</b>
Shipping Plug (Suction) (Use with C95-4001)	<b>C95-3006</b>

Tools	
Clutch Puller	<b>T65-1000</b>
Helical Insert Drill for 8-1.25mm Inserts	<b>T10-6053</b>
Helical Insert Tap 8-1.25mm	<b>T10-6254</b>
Helical Insert Tool 8-1.25mm - Bolt Style	<b>T10-6554</b>
Shaft Seal Protector	<b>T45-1002</b>
Shaft Seal Protector, Adjustable	<b>T95-1230</b>
Helical Insert Repair Kit (8-1.25mm)	<b>K10-1180</b>



Includes: Helical Inserts (25), Drill (1), Tap (1), Installation Tool - Bolt Style (1)

## HITACHI

### MJ110

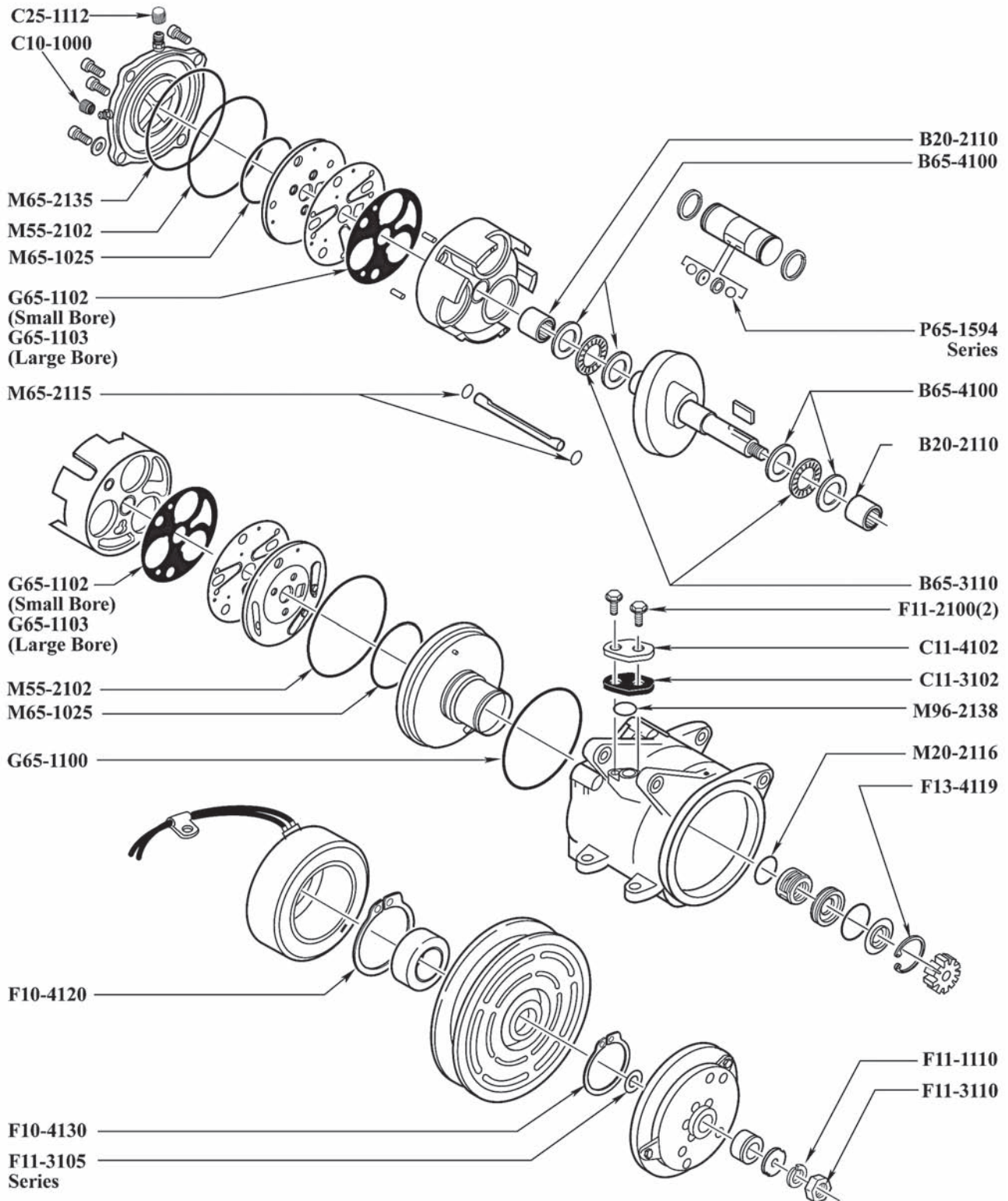

## HITACHI

### MJ110

O-Rings	R134a and R-12 Compatible	Green HNBR	Black Nitrile
Carbon Shaft Seal O-Ring		<b>M20-2116</b>	<b>M20-1016</b>
Case O-Ring (Rear)		<b>M65-2135</b>	<b>M65-1035</b>
Crossover Tube O-Ring		<b>M65-2115</b>	<b>M65-1015</b>
Inner Valve Plate O-Ring			<b>M65-1025</b>
Outer Valve Plate O-Ring		<b>M55-2102</b>	
Suction Port O-Ring		<b>M96-2138</b>	<b>M96-1038</b>

#### Bearings

Case Bearing (16mm x 23mm x 16mm)	<b>B20-2110</b>
Thrust Bearing (20.1mm x 34.7mm x 2mm)	<b>B65-3110</b>
Thrust Race (2.30mm)	<b>B65-4100</b>

#### Chemicals

Ultra PAG Oil 46 - 6pk, 8 oz Bottle	<b>MT3012</b>
Ultra PAG Oil 46 - 6pk, Quart Bottle	<b>MT3018</b>
Ultra PAG Oil 46 - Drum (52 gal)	<b>A10-6163</b>

#### Fasteners

Bolt - Shipping Plate	<b>F11-2100</b>
Helical Insert - Rear Head / Shipping Plate (8-1.25 x 12mm)	<b>F10-6211</b>
Nut - Shaft	<b>F11-1110</b>
Retaining Ring - Coil	<b>F10-4120</b>
Retaining Ring - Pulley	<b>F10-4130</b>
Retaining Ring - Shaft Seal Seat	<b>F13-4119</b>
Lockwasher - Shaft	<b>F11-3110</b>
Shim - Clutch (0.20mm)	<b>F11-3105</b>
Shim - Clutch (0.51mm)	<b>F11-3115</b>

#### Gaskets

Gasket - Cylinder (31.9mm Bore)	Fiber <b>G65-1102</b>
Gasket - Cylinder (37.0mm Bore)	Fiber <b>G65-1103</b>
Gasket - Front Case	Fiber <b>G65-1100</b>
Gasket Kit (Fiber) (31.9mm Bore)	Black Nitrile <b>K65-2005</b>

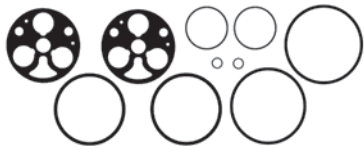

Includes: Case Gasket (1), Cylinder Gasket (2), Outer Valve Plate O-Ring (2), Crossover O-Ring(2), Inner Plate O-Ring (2), Rear Head O-Ring (1)

#### Gaskets

Gasket Kit (Fiber) (37.0mm Bore) Black Nitrile **K65-2011**

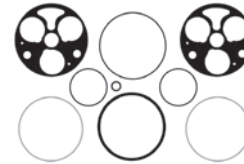

Includes: Case Gasket (1), Cylinder Gasket (2), Outer Valve Plate O-Ring (2), Crossover O-Ring (1), Inner Valve Plate O-Ring (2), Rear Head O-Ring (1)

#### Piston Components

Piston Ball (15.08mm)	<b>P65-1594</b>
Piston Ball (15.11mm)	<b>P65-1595</b>

#### Shipping Closures

Cap - 1/4" Low Side	<b>C10-1000</b>
Cap - 7/16" Service Port (Permanent)	<b>C10-1120</b>
Discharge Cap w/ O-Ring - 4/5" (.800") Height	<b>C25-1112</b>
Shipping Pad (Use with C11-4102)	<b>C11-3102</b>
Shipping Plate (Use with C11-3102)	<b>C11-4102</b>

#### Tools

Clutch Puller	<b>T65-1000</b>
Helical Insert Drill for 8-1.25mm Inserts	<b>T10-6053</b>
Helical Insert Tap 8-1.25mm	<b>T10-6254</b>
Helical Insert Tool 8-1.25mm - Bolt Style	<b>T10-6554</b>
Shaft Seal Protector	<b>T11-1000</b>
Shaft Seal Protector, Adjustable	<b>T95-1228</b>
Helical Insert Repair Kit (8-1.25mm)	<b>K10-1180</b>



Includes: Helical Inserts (25), Drill (1), Tap (1), Installation Tool - Bolt Style (1)

## HITACHI

### MJ123

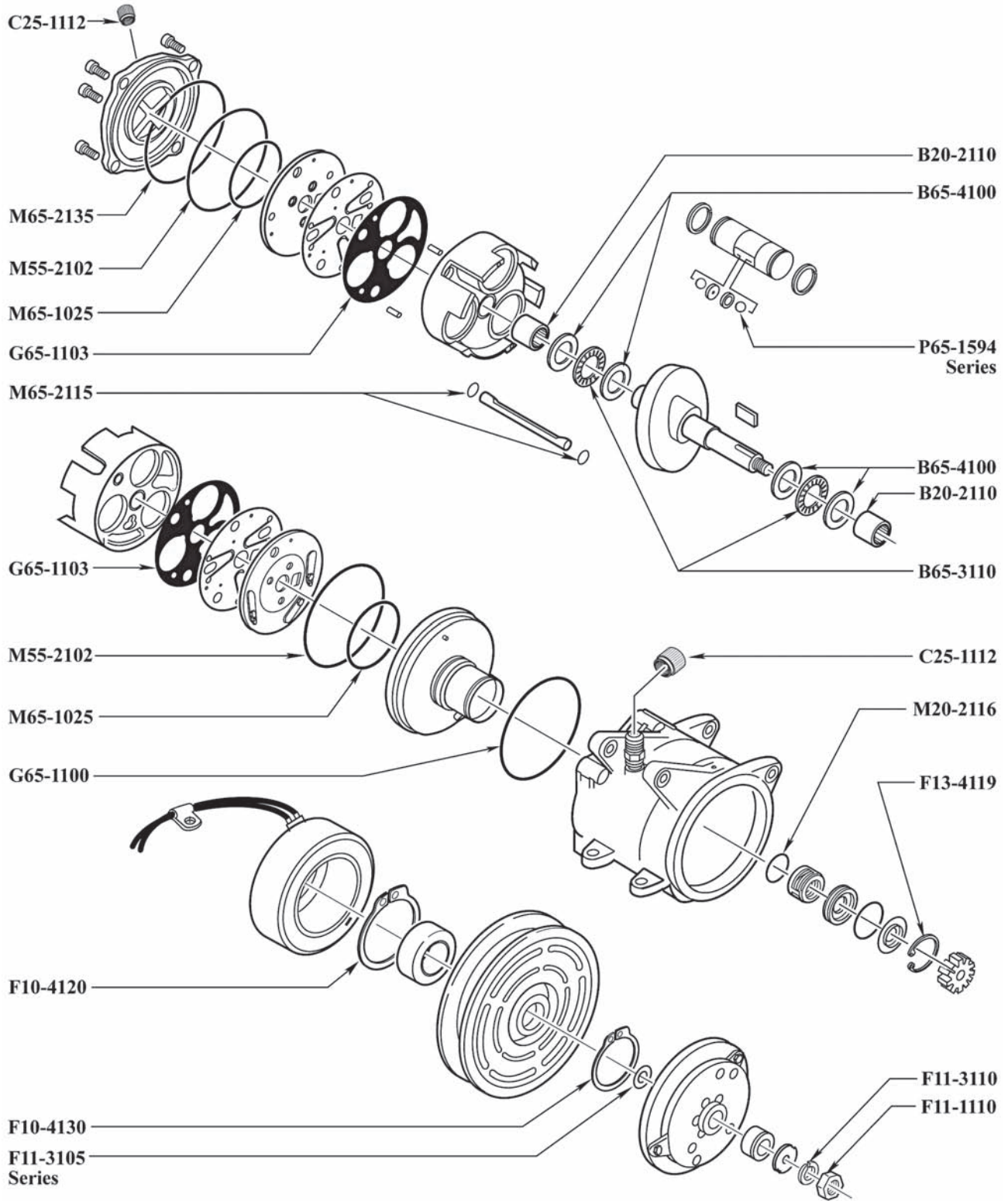



## HITACHI

### MJ123

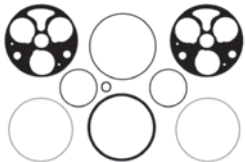
O-Rings	R134a and R-12 Compatible	Green HNBR	Black Nitrile
Carbon Shaft Seal O-Ring		M20-2116	M20-1016
Case O-Ring (Rear)		M65-2135	M65-1035
Crossover Tube O-Ring		M65-2115	M65-1015
Inner Valve Plate O-Ring			M65-1025
Outer Valve Plate O-Ring		M55-2102	
Suction Port O-Ring		M96-2138	M96-1038
<b>Bearings</b>			
Case Bearing (16mm x 23mm x 16mm)	B20-2110		
Thrust Bearing (20.1mm x 34.7mm x 2mm)	B65-3110		
Thrust Race (2.30mm)	B65-4100		
<b>Chemicals</b>			
Ultra PAG Oil 46 - 6pk, 8 oz Bottle	MT3012		
Ultra PAG Oil 46 - 6pk, Quart Bottle	MT3018		
Ultra PAG Oil 46 - Drum (52 gal)	A10-6163		
<b>Fasteners</b>			
Nut - Shaft	F11-1110		
Retaining Ring - Coil	F10-4120		
Retaining Ring - Pulley	F10-4130		
Retaining Ring - Shaft Seal Seat	F13-4119		
Lockwasher - Shaft	F11-3110		
Shim - Clutch (0.20mm)	F11-3105		
Shim - Clutch (0.51mm)	F11-3115		
<b>Gaskets</b>			
Gasket - Cylinder	Fiber	G65-1103	
Gasket - Front Case	Fiber	G65-1100	
Gasket Kit (Fiber)	Black Nitrile	K65-2011	
			
<p><i>Includes: Case Gasket (1), Cylinder Gasket (2), Outer Valve Plate O-Ring (2), Crossover O-Ring (1), Inner Valve Plate O-Ring (2), Rear Head O-Ring (1)</i></p>			
<b>Piston Components</b>			
Piston Ball (15.08mm)	P65-1594		
Piston Ball (15.11mm)	P65-1595		
<b>Shipping Closures</b>			
Discharge Cap w/ O-Ring - 4/5" (.800") Height	C25-1112		
<b>Tools</b>			
Clutch Puller	T65-1000		
Shaft Seal Protector, Adjustable	T95-1230		

## HITACHI

### MJ167

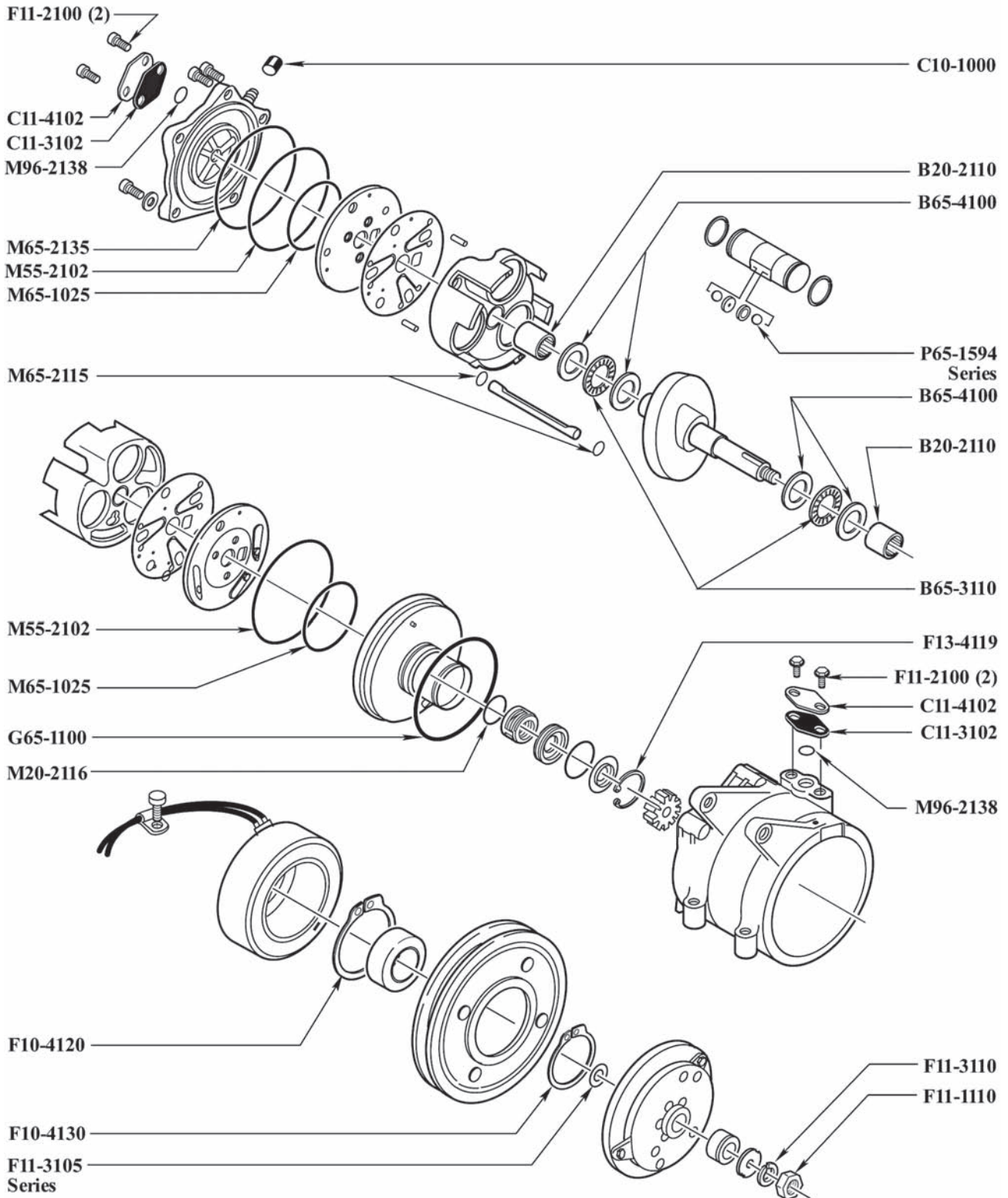

## HITACHI

### MJ167

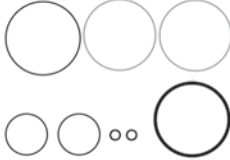
O-Rings	R134a and R-12 Compatible	Green HNBR	Black Nitrile		
Carbon Shaft Seal O-Ring		M20-2116	M20-1016		
Case O-Ring (Rear)		M65-2135	M65-1035		
Crossover Tube O-Ring		M65-2115	M65-1015		
Inner Valve Plate O-Ring			M65-1025		
Outer Valve Plate O-Ring		M55-2102			
Suction/Discharge Port O-Ring		M96-2138	M96-1038		
Bearings		Shipping Closures			
Case Bearing (16mm x 23mm x 16mm)	B20-2110	Shipping Plate (Use with C11-3102)	C11-4102		
Thrust Bearing (20.1mm x 34.7mm x 2mm)	B65-3110	Tools			
Thrust Race (2.30mm)	B65-4100	Clutch Puller	T65-1000		
Chemicals		Helical Insert Drill for 8-1.25mm Inserts	T10-6053		
Ultra PAG Oil 46 - 6pk, 8 oz Bottle	MT3012	Helical Insert Tap 8-1.25mm	T10-6254		
Ultra PAG Oil 46 - 6pk, Quart Bottle	MT3018	Helical Insert Tool 8-1.25mm - Bolt Style	T10-6554		
Ultra PAG Oil 46 - Drum (52 gal)	A10-6163	Shaft Seal Protector	T45-1002		
Fasteners		Shaft Seal Protector, Adjustable	T95-1230		
Bolt - Shipping Plate	F11-2100	Helical Insert Repair Kit (8-1.25mm)	K10-1180		
Helical Insert - Rear Head / Shipping Plate (8-1.25 x 12mm)	F10-6211	 <p><i>Includes: Helical Inserts (25), Drill (1), Tap (1), Installation Tool - Bolt Style (1)</i></p>			
Nut - Shaft	F11-1110				
Retaining Ring - Coil	F10-4120				
Retaining Ring - Pulley	F10-4130				
Retaining Ring - Shaft Seal Seat	F13-4119				
Lockwasher - Shaft	F11-3110				
Shim - Clutch (0.20mm)	F11-3105				
Shim - Clutch (0.51mm)	F11-3115				
Gaskets					
Gasket - Front Case	Fiber G65-1100				
Gasket Kit	Black Nitrile K65-2015				
 <p><i>Includes: Case Gasket (1), Outer Valve Plate O-Ring (2), Crossover O-Ring (2), Inner Valve Plate O-Ring (2), Case O-Ring (1)</i></p>					
Piston Components					
Piston Ball (15.08mm)	P65-1594				
Piston Ball (15.11mm)	P65-1595				
Shipping Closures					
Cap - 1/4" Low Side	C10-1000				
Cap - 7/16" Service Port (Permanent)	C10-1120				
Discharge Cap w/ O-Ring - 4/5" (.800") Height	C25-1112				
Shipping Pad (Use with C11-4102)	C11-3102				

## HITACHI

### MJS130

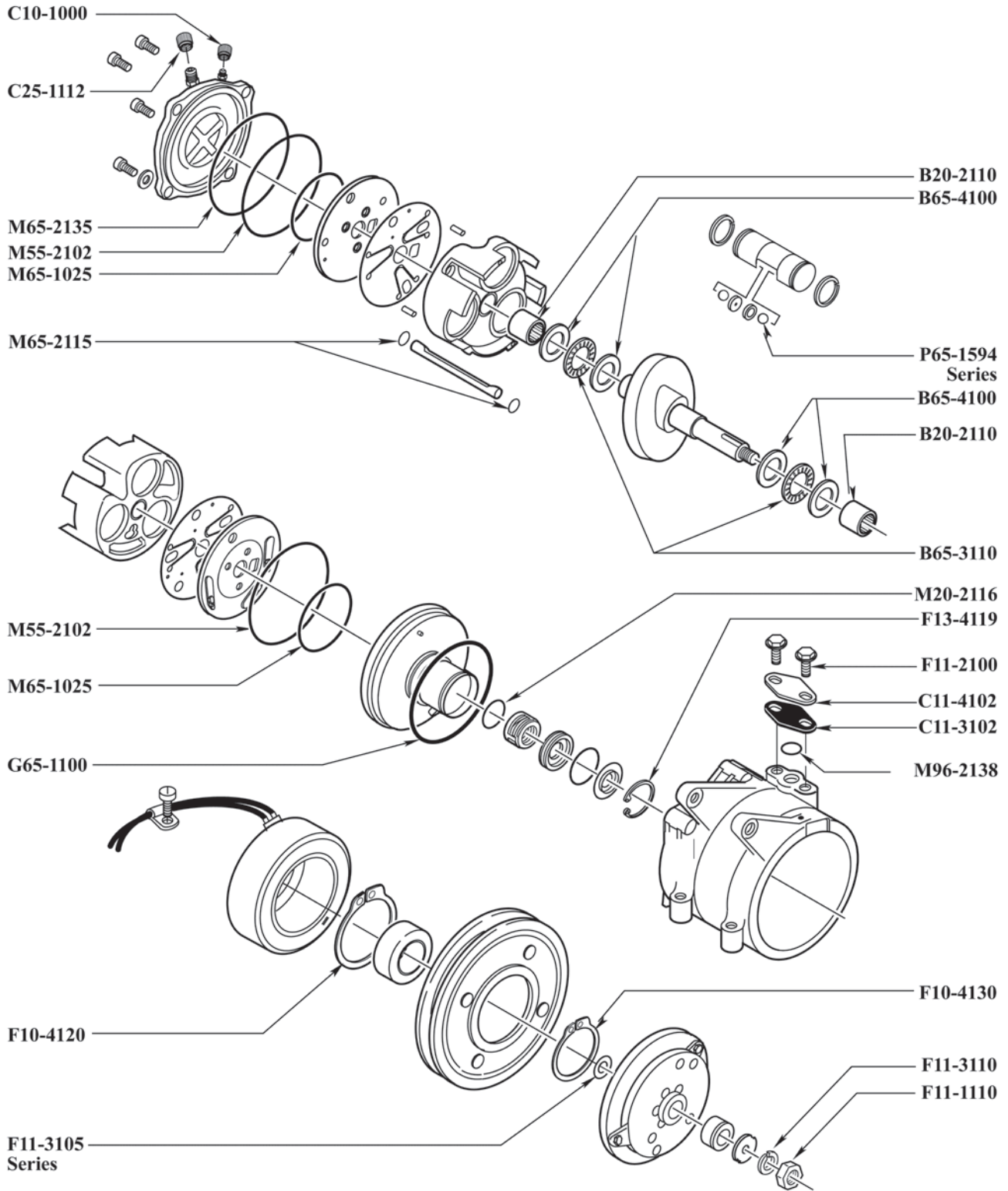

## HITACHI

### MJS130

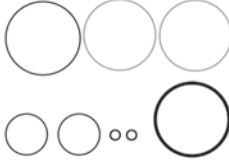
O-Rings	R134a and R-12 Compatible	Green HNBR	Black Nitrile
Carbon Shaft Seal O-Ring		<b>M20-2116</b>	<b>M20-1016</b>
Case O-Ring (Rear)		<b>M65-2135</b>	<b>M65-1035</b>
Crossover Tube O-Ring		<b>M65-2115</b>	<b>M65-1015</b>
Inner Valve Plate O-Ring			<b>M65-1025</b>
Outer Valve Plate O-Ring		<b>M55-2102</b>	
Suction Port O-Ring		<b>M96-2138</b>	<b>M96-1038</b>
Bearings		Shipping Closures	
Case Bearing (16mm x 23mm x 16mm)	<b>B20-2110</b>	Shipping Plate (Use with C11-3102)	<b>C11-4102</b>
Thrust Bearing (20.1mm x 34.7mm x 2mm)	<b>B65-3110</b>	Tools	
Thrust Race (2.30mm)	<b>B65-4100</b>	Clutch Puller	<b>T65-1000</b>
Chemicals		Helical Insert Drill for 8-1.25mm Inserts	<b>T10-6053</b>
Ultra PAG Oil 46 - 6pk, 8 oz Bottle	<b>MT3012</b>	Helical Insert Tap 8-1.25mm	<b>T10-6254</b>
Ultra PAG Oil 46 - 6pk, Quart Bottle	<b>MT3018</b>	Helical Insert Tool 8-1.25mm - Bolt Style	<b>T10-6554</b>
Ultra PAG Oil 46 - Drum (52 gal)	<b>A10-6163</b>	Shaft Seal Protector	<b>T11-1000</b>
Fasteners		Shaft Seal Protector, Adjustable	<b>T95-1228</b>
Bolt - Shipping Plate	<b>F11-2100</b>	Helical Insert Repair Kit (8-1.25mm)	<b>K10-1180</b>
Helical Insert - Rear Head / Shipping Plate (8-1.25 x 12mm)	<b>F10-6211</b>		
Nut - Shaft	<b>F11-1110</b>		
Retaining Ring - Coil	<b>F10-4120</b>		
Retaining Ring - Pulley	<b>F10-4130</b>		
Retaining Ring - Shaft Seal Seat	<b>F13-4119</b>		
Lockwasher - Shaft	<b>F11-3110</b>		
Shim - Clutch (0.20mm)	<b>F11-3105</b>		
Shim - Clutch (0.51mm)	<b>F11-3115</b>		
Gaskets			
Gasket - Front Case	Fiber <b>G65-1100</b>		
Gasket Kit	Black Nitrile <b>K65-2015</b>		
			
<p><i>Includes: Case Gasket (1), Outer Valve Plate O-Ring (2), Crossover O-Ring (2), Inner Valve Plate O-Ring (2), Case O-Ring (1)</i></p>			
Piston Components			
Piston Ball (15.08mm)	<b>P65-1594</b>		
Piston Ball (15.11mm)	<b>P65-1595</b>		
Shipping Closures			
Cap - 1/4" Low Side	<b>C10-1000</b>		
Cap - 7/16" Service Port (Permanent)	<b>C10-1120</b>		
Discharge Cap w/ O-Ring - 4/5" (.800") Height	<b>C25-1112</b>		
Shipping Pad (Use with C11-4102)	<b>C11-3102</b>		



*Includes: Helical Inserts (25), Drill (1), Tap (1), Installation Tool - Bolt Style (1)*

## HITACHI

### MJS170

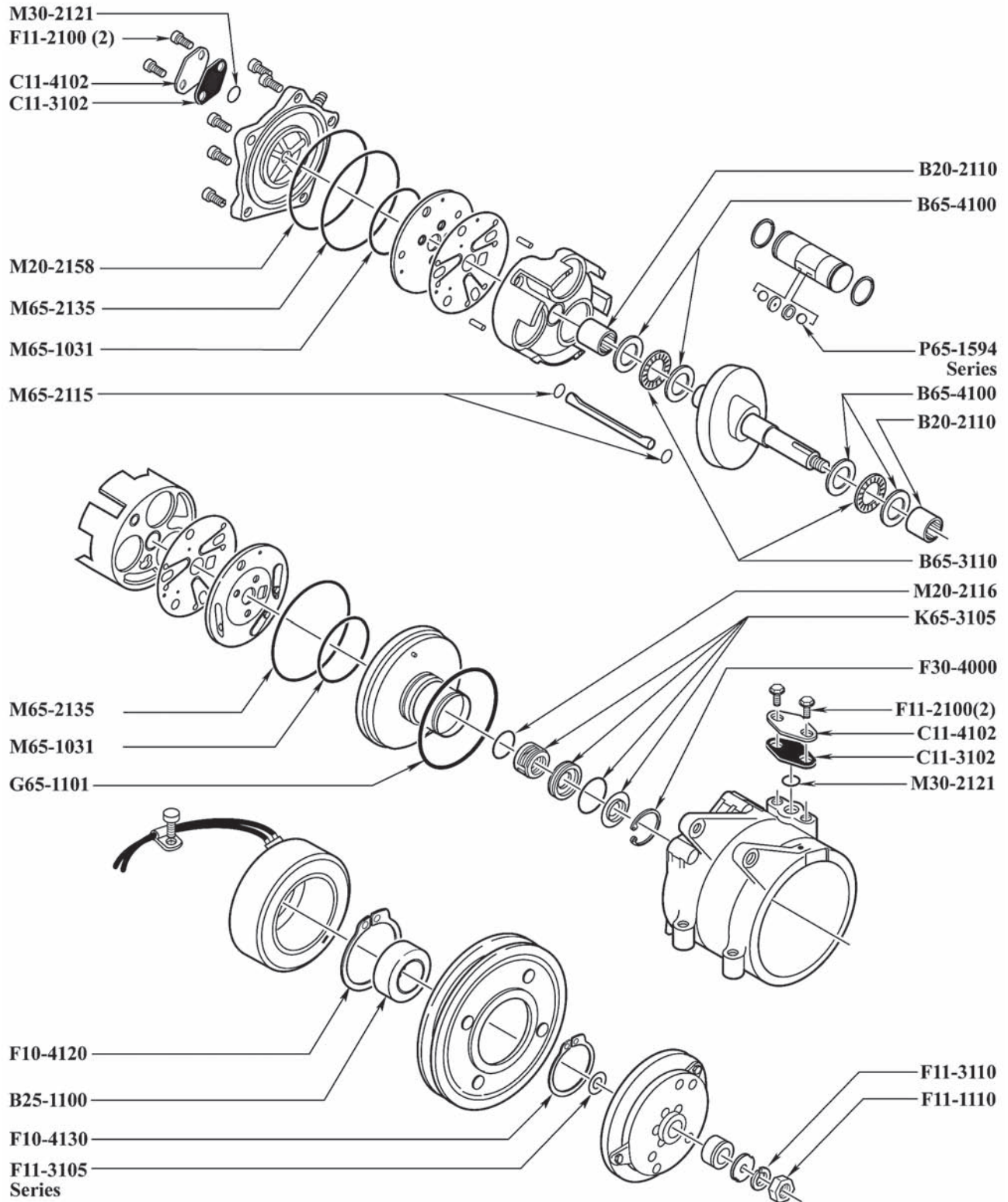

## HITACHI

### MJS170

O-Rings	R134a and R-12 Compatible	Green HNBR	Black Nitrile
Carbon Shaft Seal O-Ring		<b>M20-2116</b>	<b>M20-1016</b>
Case O-Ring		<b>M20-2158</b>	<b>M20-1058</b>
Crossover Tube O-Ring		<b>M65-2115</b>	<b>M65-1015</b>
Inner Valve Plate O-Ring			<b>M65-1031</b>
Outer Valve Plate O-Ring		<b>M65-2135</b>	<b>M65-1035</b>
Suction/Discharge Port O-Ring		<b>M30-2121</b>	
Bearings		Shipping Closures	
Case Bearing (16mm x 23mm x 16mm)	<b>B20-2110</b>	Shipping Pad (Use with C11-4102)	<b>C11-3102</b>
Clutch Bearing (40mm x 62mm x 24mm)	<b>B25-1100</b>	Shipping Plate (Use with C11-3102)	<b>C11-4102</b>
Thrust Bearing (20.1mm x 34.7mm x 2mm)	<b>B65-3110</b>	Shipping Plate (Use with C95-3004 & C95-3006)	<b>C95-4001</b>
Thrust Race (2.30mm)	<b>B65-4100</b>	Shipping Plug (Discharge) (Use with C95-4001)	<b>C95-3004</b>
Chemicals		Shipping Plug (Suction) (Use with C95-4001)	<b>C95-3006</b>
Ultra PAG Oil 46 - 6pk, 8 oz Bottle	<b>MT3012</b>	Tools	
Ultra PAG Oil 46 - 6pk, Quart Bottle	<b>MT3018</b>	Clutch Puller	<b>T65-1000</b>
Ultra PAG Oil 46 - Drum (52 gal)	<b>A10-6163</b>	Helical Insert Drill for 8-1.25mm Inserts	<b>T10-6053</b>
Fasteners		Helical Insert Tap 8-1.25mm	<b>T10-6254</b>
Bolt - Shipping Plate	<b>F11-2100</b>	Helical Insert Tool 8-1.25mm - Bolt Style	<b>T10-6554</b>
Helical Insert - Rear Head / Shipping Plate (8-1.25 x 12mm)	<b>F10-6211</b>	Shaft Seal Protector	<b>T45-1002</b>
Nut - Shaft	<b>F11-1110</b>	Shaft Seal Protector, Adjustable	<b>T95-1230</b>
Retaining Ring - Coil	<b>F10-4120</b>	Helical Insert Repair Kit (8-1.25mm)	<b>K10-1180</b>
Retaining Ring - Lip Seal	<b>F30-4000</b>		
Retaining Ring - Pulley	<b>F10-4130</b>		
Lockwasher - Shaft	<b>F11-3110</b>		
Shim - Clutch (0.20mm)	<b>F11-3105</b>		
Shim - Clutch (0.51mm)	<b>F11-3115</b>		
Gaskets			
Gasket - Front Case	Fiber <b>G65-1101</b>		
Gasket Kit (Fiber)	Black Nitrile <b>K65-2000</b>		



Includes: Helical Inserts (25), Drill (1), Tap (1), Installation Tool - Bolt Style (1)

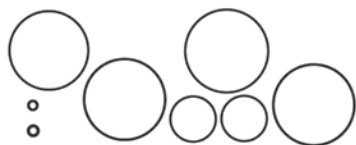

Includes: Case Gasket (1), Case O-Ring (1), Crossover O-Ring (2), Inner Valve Plate O-Ring (2), Outer Valve Plate O-Ring (2)

### Piston Components

Piston Ball (15.08mm)	<b>P65-1594</b>
Piston Ball (15.11mm)	<b>P65-1595</b>

### Shaft Seals

Lip Seal (Black Rubber Coated)	HNBR <b>S65-1100</b>
--------------------------------	----------------------

## HITACHI SWP123, SWP167

- SWP123 Only**
- C10-1000
  - C25-1110

- SWP167 Only**
- F11-2100
  - C11-4102
  - C11-3102

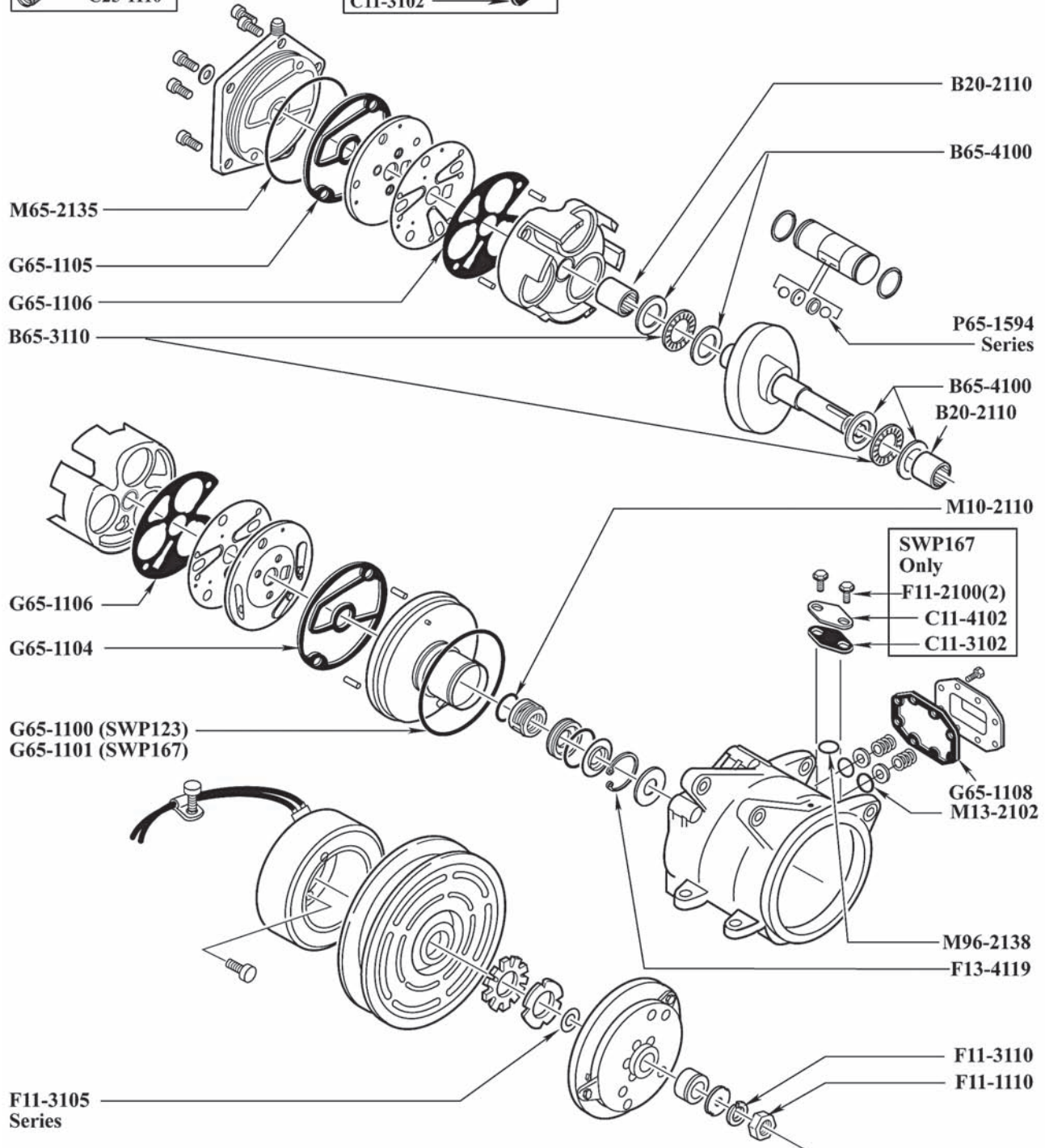



## HITACHI

### SWP123, SWP167

O-Rings	R134a and R-12 Compatible	Green HNBR	Black Nitrile
Carbon Shaft Seal O-Ring		<b>M10-2110</b>	<b>M10-1010</b>
Case O-Ring (Rear)		<b>M65-2135</b>	<b>M65-1035</b>
Crossover O-Ring		<b>M13-2102</b>	<b>M13-1002</b>
Pickup Tube O-Ring		<b>M65-2105</b>	<b>M65-1005</b>
Suction Port O-Ring (SWP167)		<b>M96-2138</b>	<b>M96-1038</b>
Bearings		Piston Components	
Case Bearing (16mm x 23mm x 16mm)	<b>B20-2110</b>	Piston Ball (15.11mm)	<b>P65-1595</b>
Thrust Bearing (20.1mm x 34.7mm x 2mm)	<b>B65-3110</b>	Shipping Closures	
Thrust Race (2.30mm)	<b>B65-4100</b>	Cap - 1/4" Low Side	<b>C10-1000</b>
Chemicals		Cap - 7/16" Service Port (Permanent)	<b>C10-1120</b>
Ultra PAG Oil 46 - 6pk, 8 oz Bottle	<b>MT3012</b>	Discharge Cap w/ O-Ring - 5/8" (.625") Height	<b>C25-1110</b>
Ultra PAG Oil 46 - 6pk, Quart Bottle	<b>MT3018</b>	Shipping Pad (Use with C11-4102)	<b>C11-3102</b>
Ultra PAG Oil 46 - Drum (52 gal)	<b>A10-6163</b>	Shipping Plate (Use with C11-3102)	<b>C11-4102</b>
Fasteners		Shipping Plate (Use with C95-3005/C95-3006)(SWP16)	<b>C95-4001</b>
Bolt - Shipping Plate	<b>F11-2100</b>	Shipping Plug (Discharge) (Use with C95-4001) (SWP167)	<b>C95-3005</b>
Helical Insert - Rear Head / Shipping Plate (8-1.25 x 12mm)	<b>F10-6211</b>	Shipping Plug (Suction) (Use with C95-4001) (SWP167)	<b>C95-3006</b>
Nut - Shaft	<b>F11-1110</b>	Tools	
Retaining Ring - Shaft Seal Seat	<b>F13-4119</b>	Clutch Puller	<b>T65-1000</b>
Lockwasher - Shaft	<b>F11-3110</b>	Helical Insert Drill for 8-1.25mm Inserts	<b>T10-6053</b>
Shim - Clutch (0.20mm)	<b>F11-3105</b>	Helical Insert Tap 8-1.25mm	<b>T10-6254</b>
Shim - Clutch (0.51mm)	<b>F11-3115</b>	Helical Insert Tool 8-1.25mm - Bolt Style	<b>T10-6554</b>
Gaskets		Shaft Seal Protector	<b>T45-1002</b>
Gasket - Cylinder	Fiber <b>G65-1106</b>	Shaft Seal Protector, Adjustable	<b>T95-1230</b>
Gasket - Front Case (SWP123)	Fiber <b>G65-1100</b>	Helical Insert Repair Kit (8-1.25mm)	<b>K10-1180</b>
Gasket - Front Case (SWP167)	Fiber <b>G65-1101</b>		
Gasket - Front Head	Fiber <b>G65-1104</b>		
Gasket - Rear Head	Fiber <b>G65-1105</b>		
Gasket - Side Plate	Fiber <b>G65-1108</b>		
Gasket Kit (Fiber)	Black Nitrile <b>K65-2020</b>		

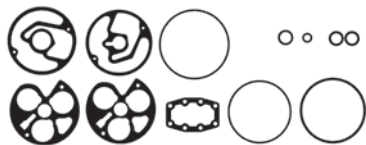

Includes: Case Gasket (2), Front Head Gasket (1), Rear Head Gasket (1), Cylinder Gasket (2), Side Plate Gasket (1), Pickup Tube O-Ring (1), Rear Head O-Ring (1), Crossover O-Ring (2), Suction Port O-Ring (1).



Includes: Helical Inserts (25), Drill (1), Tap (1), Installation Tool - Bolt Style (1)

Piston Components	
Piston Ball (15.08mm)	<b>P65-1594</b>

## KEIHIN

150L

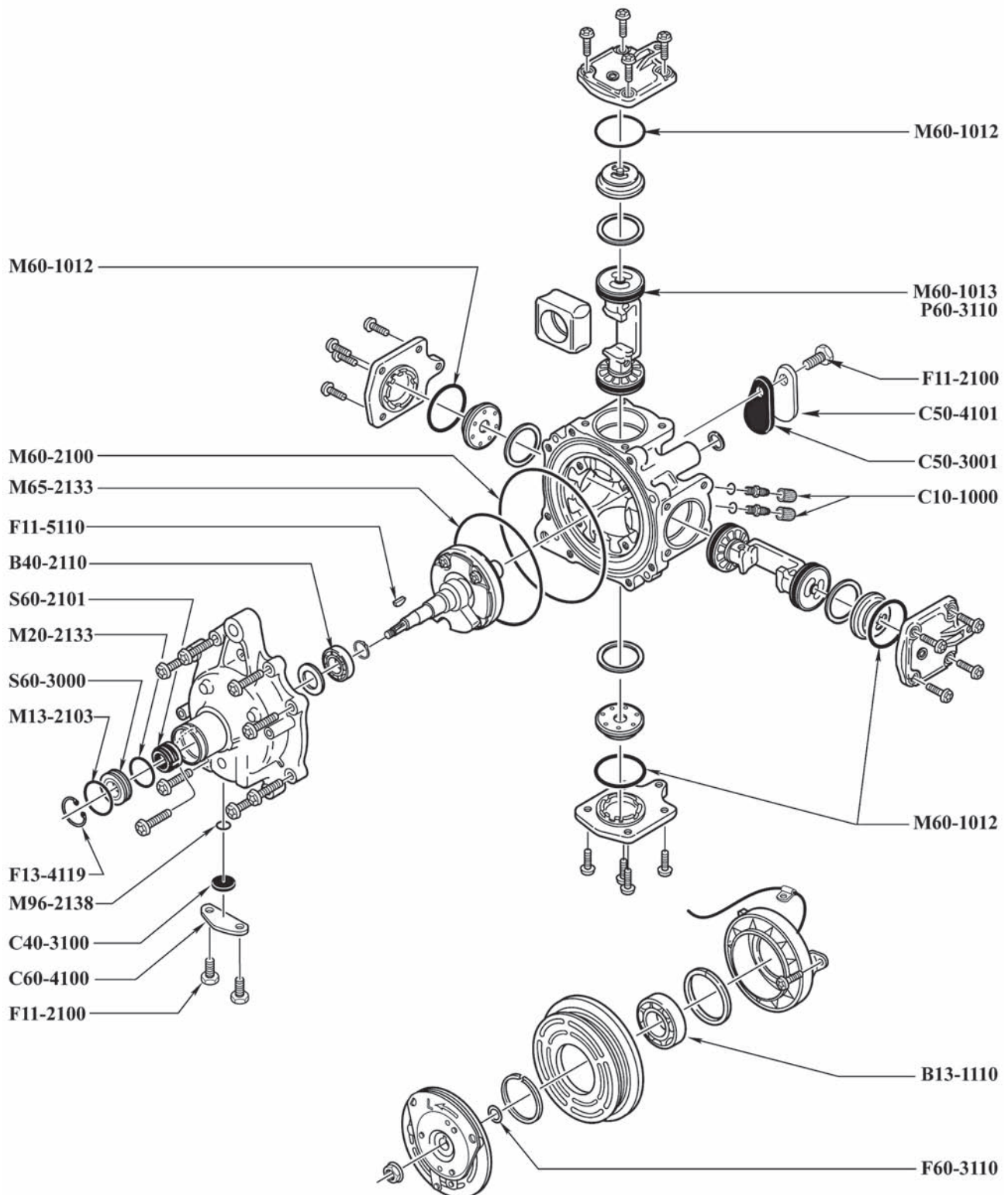

## KEIHIN

150L

O-Rings	R134a and R-12 Compatible	Green HNBR	Black Nitrile
Carbon Shaft Seal O-Ring		<b>M20-2133</b>	
Case O-Ring (Inner)		<b>M65-2133</b>	<b>M65-1033</b>
Case O-Ring (Outer)		<b>M60-2100</b>	<b>M60-1000</b>
Head Plate O-Ring			<b>M60-1012</b>
Piston O-Ring (Fits under Piston Ring)			<b>M60-1013</b>
Shaft Seal Seat O-Ring		<b>M13-2103</b>	<b>M13-1003</b>
Suction Port O-Ring		<b>M96-2138</b>	<b>M96-1038</b>

### Bearings

Case Bearing (Front) (17mm x 40mm x 12mm)	<b>B40-2110</b>
Clutch Bearing (40mm x 62mm x 20.6mm)	<b>B13-1110</b>

### Chemicals

Ultra PAG Oil 100 - 6pk, 8 oz Bottle	<b>MT3013</b>
Ultra PAG Oil 100 - 6pk, Quart Bottle	<b>MT3019</b>
Ultra PAG Oil 100 - Drum (52 gal)	<b>A10-6164</b>

### Fasteners

Bolt - Shipping Plate	<b>F11-2100</b>
Helical Insert - Case Bolt (8-1.25 x 12mm)	<b>F10-6211</b>
Shaft Key	<b>F11-5110</b>
Retaining Ring - Shaft Seal Seat	<b>F13-4119</b>
Shim - Clutch (0.13mm)	<b>F60-3110</b>

### Gaskets

O-Ring Kit	Black Nitrile <b>K60-2005</b>
------------	-------------------------------

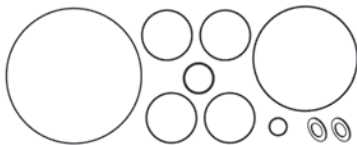

*Includes: Clutch Shim (2), Carbon Shaft Seal O-Ring (1), Head Plate O-Ring (4), Case O-Ring (Inner) (1), Case O-Ring (Outer) (1), Metal Shaft Seal O-Ring (1)*

### Piston Components

Piston Ring (1.07mm) (Standard)	<b>P60-3110</b>
---------------------------------	-----------------

### Shaft Seals

Carbon Shaft Seal Ring	HNBR <b>S60-2101</b>
Metal Shaft Seal Seat	<b>S60-3000</b>

### Shaft Seals

Shaft Seal Kit	Black Nitrile <b>K60-2000</b>
----------------	-------------------------------



*Includes: Carbon Shaft Seal O-Ring (1), Metal Shaft Seal O-Ring (1), Carbon Ring (1), Metal Shaft Seal seat (1), Metal Shaft Seal Seat Retaining Ring (1).*

### Shipping Closures

Cap - 1/4" Low Side	<b>C10-1000</b>
Shipping Pad (Discharge) (Use with C50-4101)	<b>C50-3001</b>
Shipping Pad (Suction) (Use with C60-4100)	<b>C40-3100</b>
Shipping Pad (Use with C11-4103)	<b>C11-3103</b>
Shipping Plate (Discharge) (Use with C50-3001)	<b>C50-4101</b>
Shipping Plate (Suction) (Use with C40-3100)	<b>C60-4100</b>
Shipping Plate (Use with C11-3103)	<b>C11-4103</b>

### Tools

Helical Insert Drill for 8-1.25mm Inserts	<b>T10-6053</b>
Helical Insert Tap 8-1.25mm	<b>T10-6254</b>
Helical Insert Tool 8-1.25mm - Bolt Style	<b>T10-6554</b>
Piston Ring Expansion Cone (Requires T13-3010)	<b>T60-3002</b>
Piston Ring Installer	<b>T13-3010</b>
Shaft Seal Protector, Adjustable	<b>T95-1225</b>
Shaft Seal Protector, Adjustable	<b>T95-1229</b>
Shaft Seal Seat Installer / Remover (O.E.)	<b>T60-3001</b>

## KEIHIN

### 150R

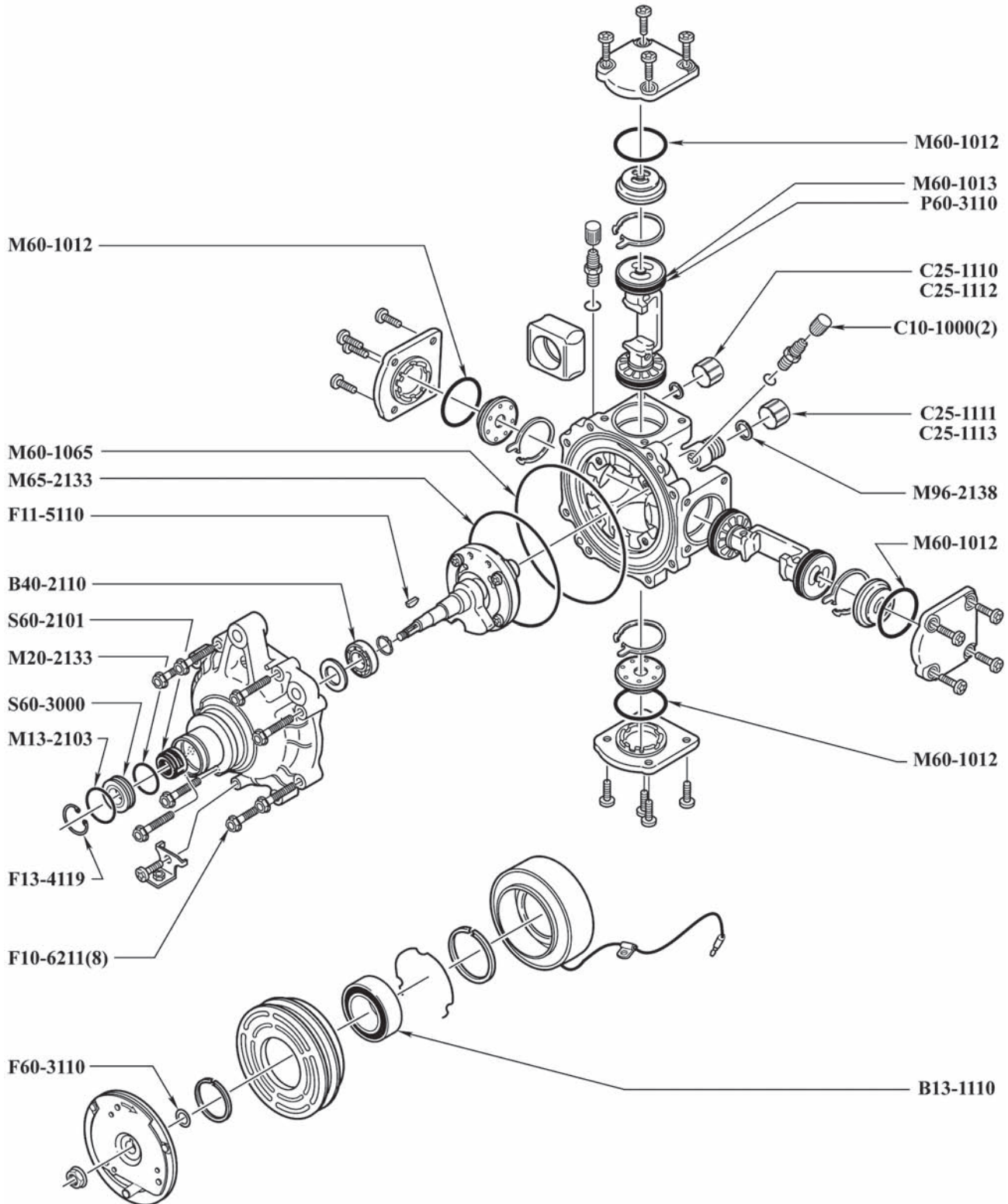

## KEIHIN

### 150R

O-Rings	R134a and R-12 Compatible	Green HNBR	Black Nitrile
Carbon Shaft Seal O-Ring		<b>M20-2133</b>	
Case O-Ring (Inner)		<b>M65-2133</b>	<b>M65-1033</b>
Case O-Ring (Outer)			<b>M60-1065</b>
Head Plate O-Ring			<b>M60-1012</b>
Piston O-Ring (Fits under Piston Ring)			<b>M60-1013</b>
Shaft Seal Seat O-Ring		<b>M13-2103</b>	<b>M13-1003</b>
Suction Port O-Ring		<b>M96-2138</b>	<b>M96-1038</b>
Bearings		Shipping Closures	
Case Bearing (Front) (17mm x 40mm x 12mm)	<b>B40-2110</b>	Cap - 1/4" Low Side	<b>C10-1000</b>
Clutch Bearing (40mm x 62mm x 20.6mm)	<b>B13-1110</b>	Discharge Cap w/ O-Ring - 4/5" (.800") Height	<b>C25-1112</b>
Chemicals		Discharge Cap w/ O-Ring - 5/8" (.625") Height	<b>C25-1110</b>
Ultra PAG Oil 100 - 6pk, 8 oz Bottle	<b>MT3013</b>	Suction Cap w/ Disc - 1" Height	<b>C25-1113</b>
Ultra PAG Oil 100 - 6pk, Quart Bottle	<b>MT3019</b>	Suction Cap w/ Disc - 7/9" (.701") Height	<b>C25-1111</b>
Ultra PAG Oil 100 - Drum (52 gal)	<b>A10-6164</b>	Tools	
Fasteners		Piston Ring Expansion Cone (Requires T13-3010)	<b>T60-3002</b>
Helical Insert - Case Bolt (8-1.25 x 12mm)	<b>F10-6211</b>	Piston Ring Installer	<b>T13-3010</b>
Shaft Key	<b>F11-5110</b>	Shaft Seal Protector, Adjustable	<b>T95-1225</b>
Retaining Ring - Shaft Seal Seat	<b>F13-4119</b>	Shaft Seal Protector, Adjustable	<b>T95-1229</b>
Shim - Clutch (0.13mm)	<b>F60-3110</b>	Shaft Seal Seat Installer / Remover (O.E.)	<b>T60-3001</b>
Gaskets		Helical Insert Repair Kit (8-1.25mm)	<b>K10-1180</b>
O-Ring Kit	Black Nitrile <b>K60-2010</b>		

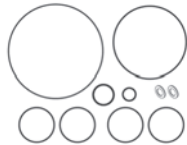

Includes: Clutch Shim (2), Carbon Shaft Seal O-Ring (1), Head Plate O-Ring (4), Case O-Ring (Inner) (1), Case O-Ring (Outer) (1), Metal Shaft Seal O-Ring (1)



Includes: Helical Inserts (25), Drill (1), Tap (1), Installation Tool - Bolt Style (1)

Piston Components	
Piston Ring (1.07mm) (Standard)	<b>P60-3110</b>
Shaft Seals	
Carbon Shaft Seal Ring	HNBR <b>S60-2101</b>
Metal Shaft Seal Seat	<b>S60-3000</b>
Shaft Seal Kit	Black Nitrile <b>K60-2000</b>



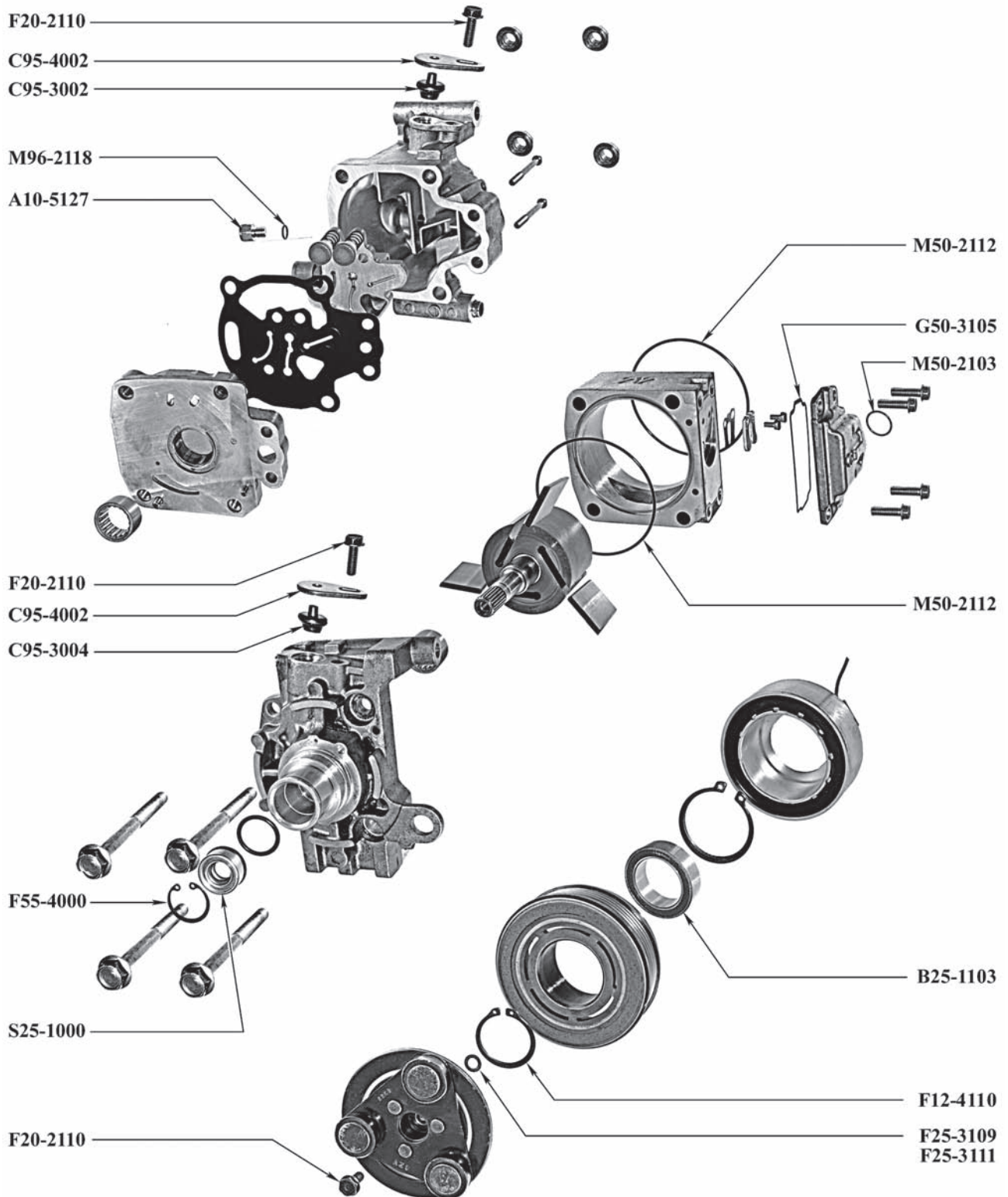

Includes: Carbon Shaft Seal O-Ring (1), Metal Shaft Seal O-Ring (1), Carbon Ring (1), Metal Shaft Seal seat (1), Metal Shaft Seal Seat Retaining Ring (1)

## MATS/PAN H12A1AH4DX



## MATS/PAN H12A1AH4DX

O-Rings	R134a and R-12 Compatible	Green HNBR	Black Nitrile
Discharge Housing O-Ring		<b>M50-2103</b>	<b>M50-1003</b>
High Pressure Relief Valve O-Ring		<b>M96-2118</b>	<b>M96-1018</b>
Rotor Housing O-Ring		<b>M50-2112</b>	<b>M50-1012</b>
<b>Bearings</b>		<b>Shipping Closures</b>	
Clutch Bearing (32mm x 47mm x 18mm)	<b>B25-1103</b>	Shipping Plug (Discharge) (Use with C95-4002)	<b>C95-3002</b>
<b>Chemicals</b>		Shipping Plug (Suction) (Use with C95-4002)	<b>C95-3004</b>
Ultra PAG Oil 46 - 6pk, 8 oz Bottle	<b>MT3012</b>	<b>Tools</b>	
Ultra PAG Oil 46 - 6pk, Quart Bottle	<b>MT3018</b>	Helical Insert Drill for 8-1.25mm Inserts	<b>T10-6053</b>
Ultra PAG Oil 46 - Drum (52 gal)	<b>A10-6163</b>	Helical Insert Tap 8-1.25mm	<b>T10-6254</b>
<b>Clutch Components</b>		Helical Insert Tool 8-1.25mm - Bolt Style	<b>T10-6554</b>
Clutch Coil - OD/ID: 87.7mm / 58.3mm (05-03 Civic Hybrid)	<b>H50-7303</b>	Helical Insert Repair Kit (8-1.25mm)	<b>K10-1180</b>
Clutch Coil - OD/ID: 88mm / 58.5mm	<b>H50-7304</b>		
Clutch Hub - OD: 100mm	<b>H50-7003</b>		
<b>Fasteners</b>			
Bolt - Shipping Plate / Shaft	<b>F20-2110</b>	<p><i>Includes: Helical Inserts (25), Drill (1), Tap (1), Installation Tool - Bolt Style (1)</i></p>	
Helical Insert - Shipping Plate (8-1.25 x 12mm)	<b>F10-6211</b>		
Retaining Ring - Lip Seal	<b>F55-4000</b>		
Retaining Ring - Pulley	<b>F12-4110</b>		
Shim - Clutch (0.38mm)	<b>F25-3111</b>		
Shim - Clutch (0.76mm)	<b>F25-3109</b>	<b>Gaskets</b>	
Manifold Molded Gasket	Green HNBR <b>G50-3105</b>	Manifold Molded Gasket	
O-Ring Kit	Green HNBR <b>K50-2112</b>	O-Ring Kit	
			
<p><i>Includes: Rotor Housing O-Ring (1), Discharge Housing O-Ring (1), High Pressure Relief Valve O-Ring (1)</i></p>			
<b>Service Items</b>			
High Pressure Relief Valve	<b>A20-5203</b>		
<b>Shaft Seals</b>			
Lip Seal	Nitrile <b>S25-1000</b>		
<b>Shipping Closures</b>			
Shipping Pad (Use with C50-4101)(Suction/Discharge)	<b>C50-3001</b>		
Shipping Plate (Use with C50-3001)	<b>C50-4101</b>		
Shipping Plate (Use with C95-3002 & C95-3004)	<b>C95-4002</b>		

## MATS/PAN

N1300AC4, NL1300AA4, NL1300AB4, NL1300AE4

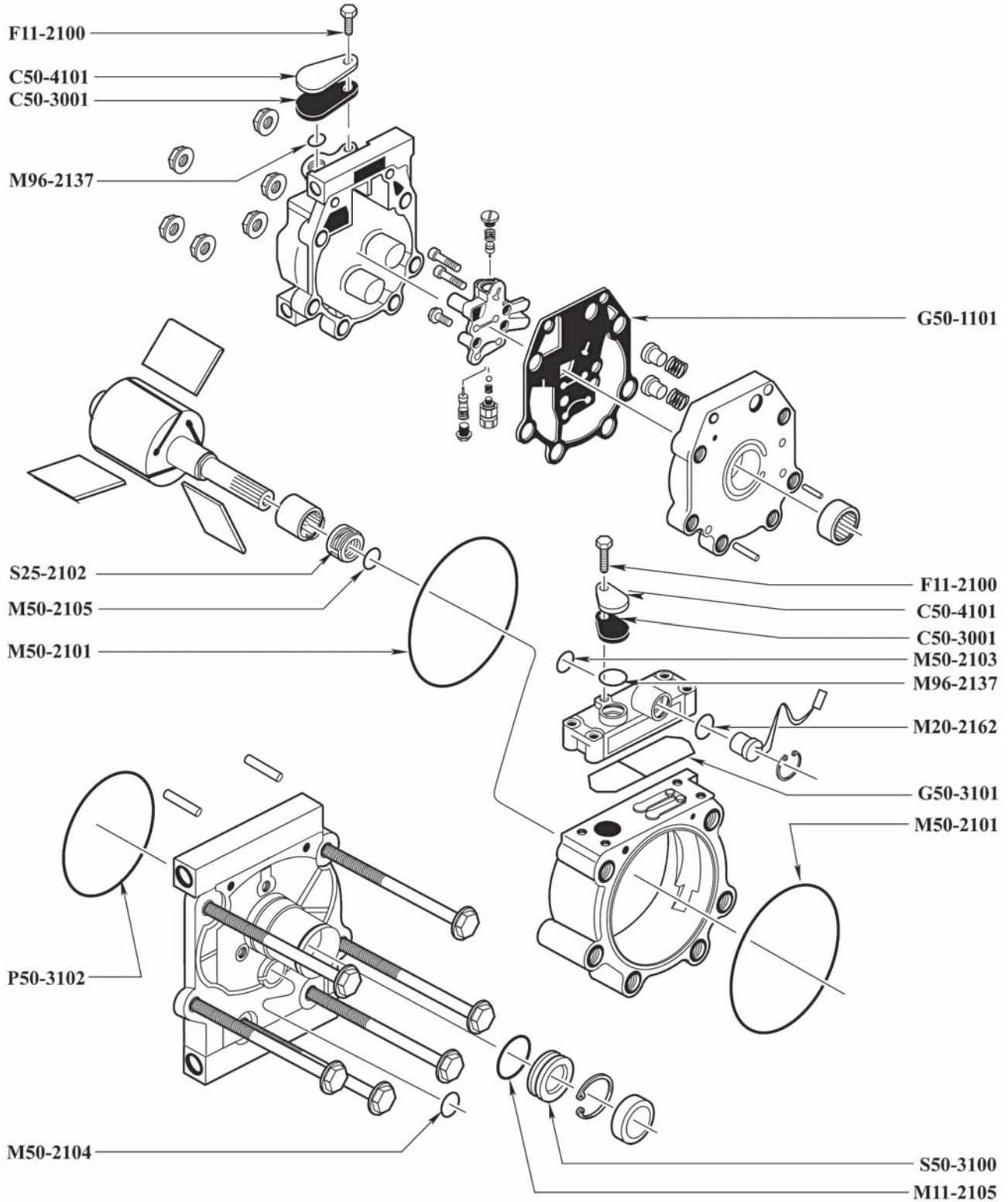



## MATS/PAN

N1300AC4, NL1300AA4, NL1300AB4, NL1300AE4

O-Rings and Lathe Cuts	R134a and R-12 Compatible	Green HNBR	Black Nitrile
Carbon Shaft Seal O-Ring		<b>M50-2105</b>	<b>M50-1005</b>
Case O-Ring		<b>M50-2101</b>	<b>M50-1001</b>
Clutch Driver Damper Lathe Cut			<b>L50-1000</b>
Discharge Housing O-Ring		<b>M50-2103</b>	<b>M50-1003</b>
Front Head Switch O-Ring		<b>M50-2104</b>	<b>M50-1004</b>
Shaft Seal Seat O-Ring		<b>M11-2105</b>	<b>M11-1005</b>
Suction / Discharge Port O-Ring		<b>M96-2137</b>	<b>M96-1037</b>
Temperature Switch O-Ring		<b>M20-2162</b>	

### Bearings

Clutch Bearing (32mm x 55mm x 23mm)	<b>B50-1100</b>
Clutch Bearing (35mm x 55mm x 20mm)	<b>B10-1107</b>

### Chemicals

Clutch Driver Damper Adhesive	<b>A10-5118</b>
Ultra PAG Oil 46 - 6pk, 8 oz Bottle	<b>MT3012</b>
Ultra PAG Oil 46 - 6pk, Quart Bottle	<b>MT3018</b>
Ultra PAG Oil 46 - Drum (52 gal)	<b>A10-6163</b>

### Fasteners

Bolt - Shipping Plate	<b>F11-2100</b>
Helical Insert - Rear Head / Shipping Plate (8-1.25 x 12mm)	<b>F10-6211</b>
Retaining Ring - Pulley	<b>F25-4112</b>
Shim - Clutch (0.38mm)	<b>F12-3110</b>

### Gaskets

Gasket - Head	Fiber <b>G50-1101</b>
Gasket - Suction / Discharge Manifold	Green HNBR <b>G50-3101</b>
Gasket Kit (Fiber)	Black Nitrile <b>K50-2002</b>

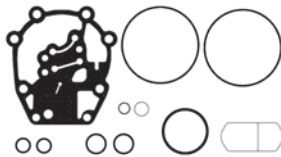

*Includes: Gaskets: Head (1), Manifold (1); Teflon Rotor Ring Seal (1); O-Rings: Case (2), Manifold Switch (1), Suction Port (1), Front Head Switch (1), Carbon Seal (1) Metal Shaft Seal Seat (1), Suction/Discharge Block (1).*

### Piston Components

Rotor Ring Seal (Teflon)	<b>P50-3102</b>
--------------------------	-----------------

### Shaft Seals

Carbon Shaft Seal	HNBR <b>S25-2102</b>
Lip Seal	HNBR <b>S50-1000</b>
Metal Shaft Seal Seat	<b>S50-3100</b>

### Shaft Seals

Carbon Shaft Seal Kit	Green HNBR <b>K50-3100</b>
-----------------------	----------------------------



*Includes: Carbon Shaft Seal (1), Metal Shaft Seal Seat (1), Metal Shaft Seal Seat O-Ring (1)*

Lip Seal Kit	Green HNBR <b>K50-3101</b>
--------------	----------------------------



*Includes: Lip Seal (1), Shaft Seal Retaining Ring (1)*

### Shipping Closures

Shipping Pad (Use with C50-4101)	<b>C50-3001</b>
Shipping Plate (Use with C50-3001)	<b>C50-4101</b>
Shipping Plate (Use with C95-3004 & C95-3006) (AA4/AE4)	<b>C95-4001</b>
Shipping Plug (Discharge) (Use with C95-4001) (AE4)	<b>C95-3006</b>
Shipping Plug (S/D on AA4, S on AE4) (Use with C95-4001)	<b>C95-3004</b>

### Tools

Helical Insert Drill for 8-1.25mm Inserts	<b>T10-6053</b>
Helical Insert Tap 8-1.25mm	<b>T10-6254</b>
Helical Insert Tool 8-1.25mm - Bolt Style	<b>T10-6554</b>
Shaft Seal Install / Remover	<b>T50-3001</b>
Shaft Seal Protector	<b>T11-1000</b>
Shaft Seal Protector, Adjustable	<b>T95-1226</b>

## MATS/PAN

N1300AC4, NL1300AA4, NL1300AB4, NL1300AE4

### Tools

Helical Insert Repair Kit (8-1.25mm)

**K10-1180**



*Includes: Helical Inserts (25), Drill (1), Tap (1), Installation Tool - Bolt Style (1)*



## MATS/PAN

N1301A0AH4, N1301AB4, N1301AD4, N1301AE4

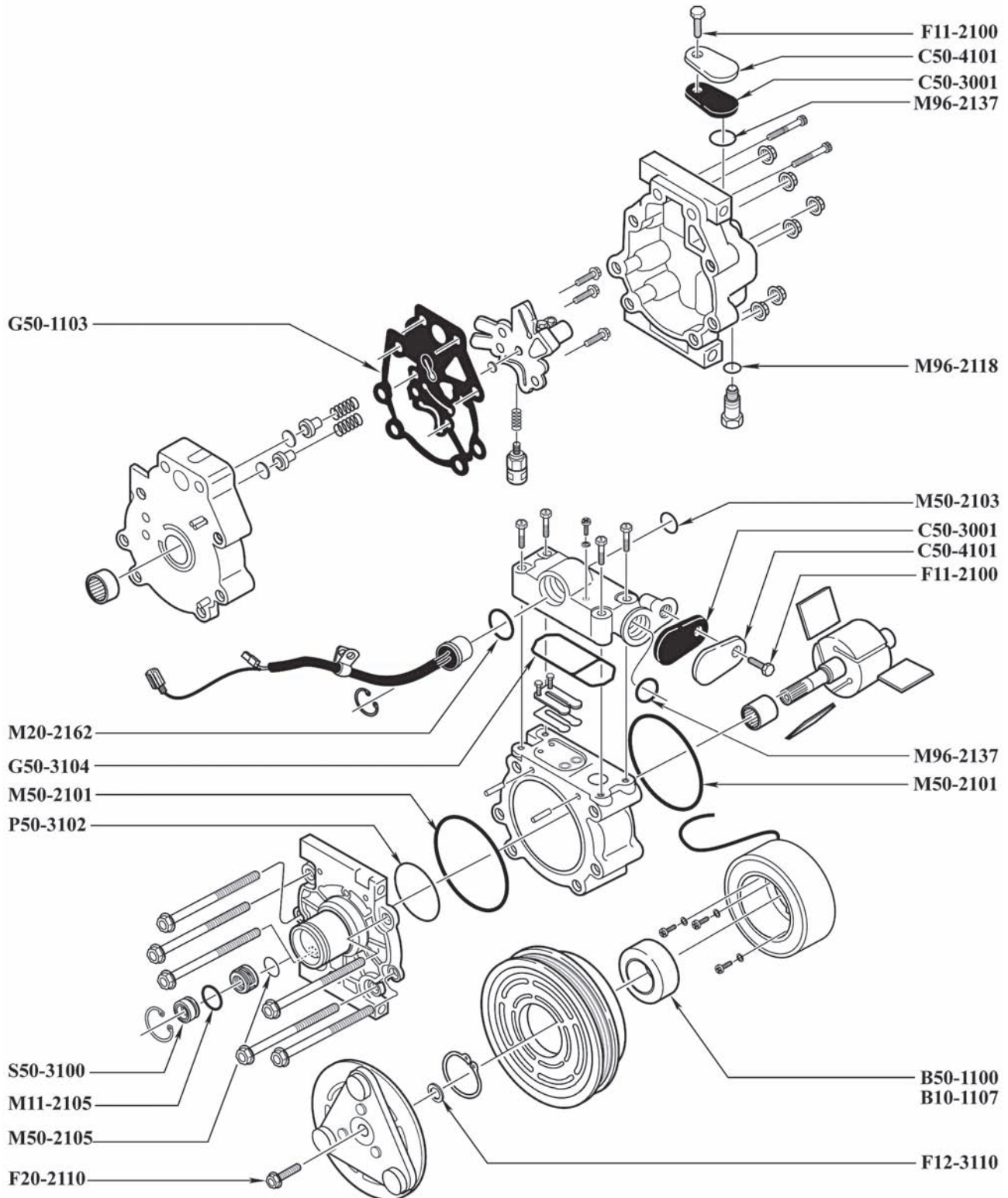

## MATS/PAN

N1301A0AH4, N1301AB4, N1301AD4, N1301AE4

O-Rings and Lathe Cuts	R134a and R-12 Compatible	Green HNBR	Black Nitrile
Carbon Shaft Seal O-Ring		<b>M50-2105</b>	<b>M50-1005</b>
Case O-Ring		<b>M50-2101</b>	<b>M50-1001</b>
Clutch Driver Damper Lathe Cut			<b>L50-1000</b>
Discharge Housing O-Ring		<b>M50-2103</b>	<b>M50-1003</b>
High Pressure Relief Valve O-Ring		<b>M96-2118</b>	<b>M96-1018</b>
Shaft Seal Seat O-Ring		<b>M11-2105</b>	<b>M11-1005</b>
Suction / Discharge Port O-Ring		<b>M96-2137</b>	<b>M96-1037</b>
Temperature Switch O-Ring		<b>M20-2162</b>	

### Bearings

Clutch Bearing (32mm x 55mm x 23mm)	<b>B50-1100</b>
Clutch Bearing (35mm x 55mm x 20mm)	<b>B10-1107</b>

### Chemicals

Clutch Driver Damper Adhesive	<b>A10-5118</b>
Ultra PAG Oil 46 - 6pk, 8 oz Bottle	<b>MT3012</b>
Ultra PAG Oil 46 - 6pk, Quart Bottle	<b>MT3018</b>
Ultra PAG Oil 46 - Drum (52 gal)	<b>A10-6163</b>

### Fasteners

Bolt - Shaft	<b>F20-2110</b>
Bolt - Shipping Plate	<b>F11-2100</b>
Helical Insert - Rear Head / Shipping Plate (8-1.25 x 12mm)	<b>F10-6211</b>
Retaining Ring - Pulley	<b>F25-4112</b>
Shim - Clutch (0.38mm)	<b>F12-3110</b>

### Gaskets

Gasket - Head	Fiber <b>G50-1103</b>
Gasket - Suction / Discharge Manifold	Green HNBR <b>G50-3104</b>
Gasket Kit (Fiber)	Green HNBR <b>K50-2107</b>

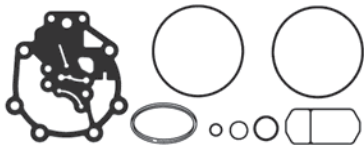

Includes: Case O-Ring (2), Suction O-Ring (1), Temperature Switch O-Ring (1), Pressure Relief Valve O-Ring (1), Teflon Rotor Ring Seal (1), Head Gasket (1), Suction Manifold Gasket (1)

### Piston Components

Rotor Ring Seal (Teflon)	<b>P50-3102</b>
--------------------------	-----------------

### Shaft Seals

Carbon Shaft Seal	HNBR <b>S25-2102</b>
Lip Seal	HNBR <b>S50-1000</b>
Metal Shaft Seal Seat	<b>S50-3100</b>

### Shaft Seals

Carbon Shaft Seal Kit	Green HNBR <b>K50-3100</b>
-----------------------	----------------------------



Includes: Carbon Shaft Seal (1), Metal Shaft Seal Seat (1), Metal Shaft Seal O-Ring (1)

Lip Seal Kit	Green HNBR <b>K50-3101</b>
--------------	----------------------------



Includes: Lip Seal (1), Shaft Seal Retaining Ring (1)

### Shipping Closures

Shipping Pad (Use with C50-4101)	<b>C50-3001</b>
Shipping Plate (Use with C50-3001)	<b>C50-4101</b>
Shipping Plate (Use with C95-3004 & C95-3006)	<b>C95-4001</b>
Shipping Plug (S/D on AB4/AD4, D on AE4) (Use with C95-4001)	<b>C95-3004</b>
Shipping Plug (Suction) (Use with C95-4001) (AE4)	<b>C95-3006</b>

### Tools

Helical Insert Drill for 8-1.25mm Inserts	<b>T10-6053</b>
Helical Insert Tap 8-1.25mm	<b>T10-6254</b>
Helical Insert Tool 8-1.25mm - Bolt Style	<b>T10-6554</b>
Shaft Seal Install / Remover	<b>T50-3001</b>
Shaft Seal Protector, Adjustable	<b>T95-1226</b>

## MATS/PAN

N1301A0AH4, N1301AB4, N1301AD4, N1301AE4

### Tools

Helical Insert Repair Kit (8-1.25mm)

**K10-1180**



*Includes: Helical Inserts (25), Drill (1), Tap (1), Installation Tool - Bolt Style (1)*



## MATS/PAN

S1150AE4, S1150F3, S1150X3

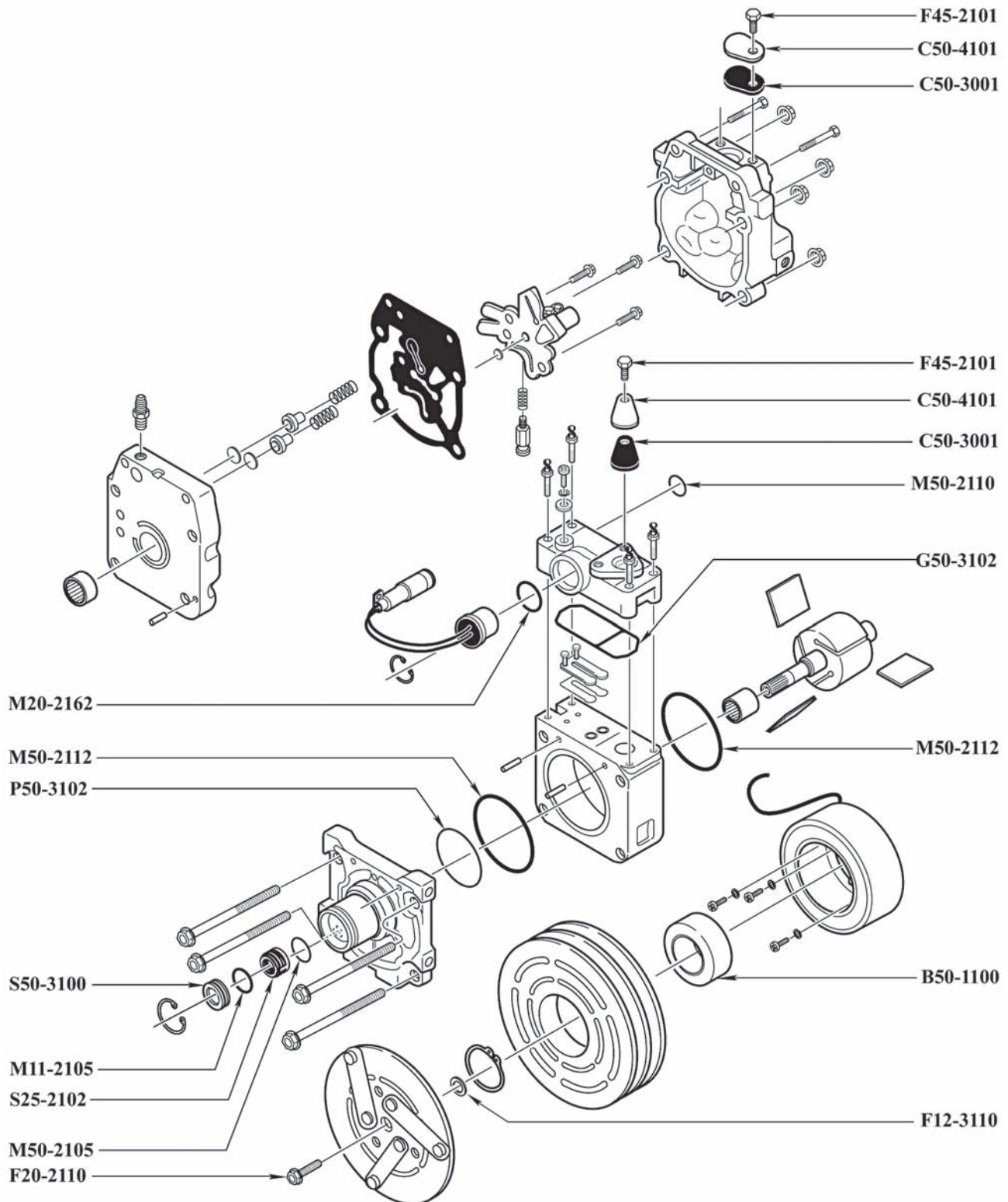



## MATS/PAN

S1150AE4, S1150F3, S1150X3

O-Rings	R134a and R-12 Compatible	Green HNBR	Black Nitrile
Carbon Shaft Seal O-Ring		<b>M50-2105</b>	<b>M50-1005</b>
Discharge Housing O-Ring		<b>M50-2110</b>	
Rotor O-Ring (Front and Rear)		<b>M50-2112</b>	<b>M50-1012</b>
Rotor Ring O-Ring		<b>M13-2102</b>	<b>M13-1002</b>
Shaft Seal Seat O-Ring		<b>M11-2105</b>	<b>M11-1005</b>
Temperature Switch O-Ring		<b>M20-2162</b>	

### Bearings

Clutch Bearing (32mm x 55mm x 23mm) **B50-1100**

### Chemicals

Ultra PAG Oil 46 - 6pk, 8 oz Bottle **MT3012**

Ultra PAG Oil 46 - 6pk, Quart Bottle **MT3018**

Ultra PAG Oil 46 - Drum (52 gal) **A10-6163**

### Fasteners

Bolt - Shaft **F20-2110**

Bolt - Shipping Plate **F45-2101**

Helical Insert - Rear Head / Shipping Plate (8-1.25 x 12mm) **F10-6211**

Shim - Clutch (0.38mm) **F12-3110**

### Gaskets

Gasket - Suction / Discharge Green HNBR **G50-3102**  
Manifold

Gasket Kit Green HNBR **K50-2105**

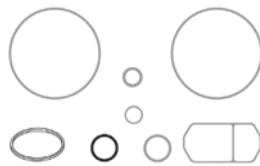

*Includes : Discharge Manifold Gasket (HNBR) (1), Carbon Shaft Seal O-Ring (1), Sensor Housing O-Ring (1), Sensor O-Ring (1), Rotor O-Ring (Front and Rear) (2), Metal Shaft Seal Seat O-Ring (1), Rotor Ring Seal (1).*

O-Ring Kit Green HNBR **K50-2108**



*Includes: Temperature Switch O-Ring (1), Discharge Housing O-Ring (1), Rotor O-Ring (1), Rotor Ring Seal (1).*

### Piston Components

Rotor Ring Seal (Teflon) **P50-3102**

### Shaft Seals

Carbon Shaft Seal HNBR **S25-2102**

### Shaft Seals

Metal Shaft Seal Seat **S50-3100**

Carbon Shaft Seal Kit Green HNBR **K50-3100**



*Includes: Carbon Shaft Seal (1), Metal Shaft Seal Seat (1), Metal Shaft Seal Seat O-Ring (1)*

### Shipping Closures

Shipping Cap - Discharge **C50-1101**

Shipping Cap - Suction **C50-1102**

Shipping Pad (Use with C50-4101) **C50-3001**

Shipping Plate (Use with C50-3001) **C50-4101**

Shipping Plate (Use with C95-3005 & C95-3006) (S1150F3) **C95-4002**

Shipping Plug (Discharge) (Use with C95-4002) (S1150F3) **C95-3005**

Shipping Plug (Suction) (Use with C95-4002) (S1150F3) **C95-3006**

### Tools

Helical Insert Tap 8-1.25mm **T10-6254**

Helical Insert Tool 8-1.25mm - Bolt Style **T10-6554**

Shaft Seal Install / Remover **T50-3001**

Shaft Seal Protector, Adjustable **T95-1226**

Helical Insert Repair Kit (8-1.25mm) **K10-1180**



*Includes: Helical Inserts (25), Drill (1), Tap (1), Installation Tool - Bolt Style (1)*

## MATS/PAN

SA1150AE4

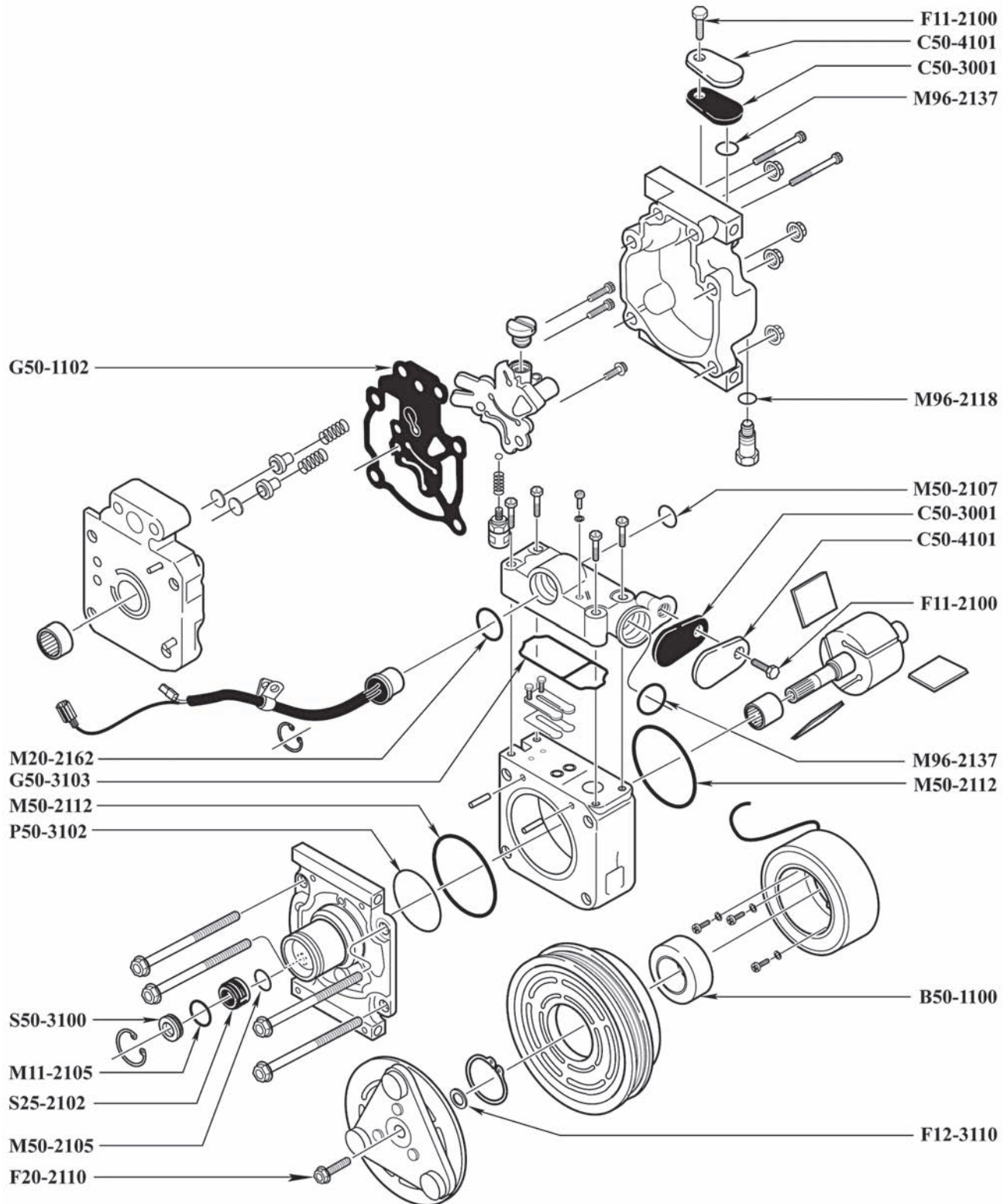

## MATS/PAN

SA1150AE4

O-Rings and Lathe Cuts	R134a and R-12 Compatible	Green HNBR	Black Nitrile
Carbon Shaft Seal O-Ring		<b>M50-2105</b>	<b>M50-1005</b>
Case O-Ring		<b>M50-2112</b>	<b>M50-1012</b>
Clutch Driver Damper Lathe Cut			<b>L50-1000</b>
Discharge Housing O-Ring		<b>M50-2107</b>	
High Pressure Relief Valve O-Ring		<b>M96-2118</b>	<b>M96-1018</b>
Shaft Seal Seat O-Ring		<b>M11-2105</b>	<b>M11-1005</b>
Suction / Discharge Port O-Ring		<b>M96-2137</b>	<b>M96-1037</b>
Temperature Switch O-Ring		<b>M20-2162</b>	

### Bearings

Clutch Bearing (32mm x 55mm x 23mm) **B50-1100**

### Chemicals

Clutch Driver Damper Adhesive **A10-5118**

Ultra PAG Oil 46 - 6pk, 8 oz Bottle **MT3012**

Ultra PAG Oil 46 - 6pk, Quart Bottle **MT3018**

Ultra PAG Oil 46 - Drum (52 gal) **A10-6163**

### Fasteners

Bolt - Shaft **F20-2110**

Bolt - Shipping Plate **F11-2100**

Helical Insert - Rear Head / Shipping Plate (8-1.25 x 12mm) **F10-6211**

Shim - Clutch (0.38mm) **F12-3110**

### Gaskets

Gasket - Head Fiber **G50-1102**

Gasket - Suction / Discharge Manifold Green HNBR **G50-3103**

Gasket Kit (Fiber) (R12 Type) Green HNBR **K50-2106**

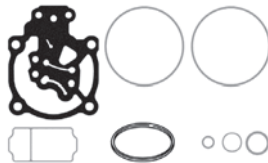

*Includes: Head Gasket (1), Manifold Gasket (1), Case O-Ring (2), Temperature Switch O-Ring (1), Suction Housing O-Ring (1), Pressure Relief Valve O-Ring (1), Teflon Rotor Ring Seal (1).*

### Piston Components

Rotor Ring Seal (Teflon) **P50-3102**

### Shaft Seals

Carbon Shaft Seal HNBR **S25-2102**

Metal Shaft Seal Seat **S50-3100**

### Shaft Seals

Carbon Shaft Seal Kit Green HNBR **K50-3100**



*Includes: Carbon Shaft Seal (1), Metal Shaft Seal Seat (1), Metal Shaft Seal Seat O-Ring (1)*

### Shipping Closures

Shipping Pad (Use with C50-4101) **C50-3001**

Shipping Plate (Use with C50-3001) **C50-4101**

Shipping Plate (Use with C95-3004 & C95-3006) **C95-4001**

Shipping Plug (Discharge) (Use with C95-4001) **C95-3004**

Shipping Plug (Suction) (Use with C95-4001) **C95-3006**

### Tools

Helical Insert Drill for 8-1.25mm Inserts **T10-6053**

Helical Insert Tap 8-1.25mm **T10-6254**

Helical Insert Tool 8-1.25mm - Bolt Style **T10-6554**

Shaft Seal Install / Remover **T50-3001**

Shaft Seal Protector, Adjustable **T95-1226**

Helical Insert Repair Kit (8-1.25mm) **K10-1180**



*Includes: Helical Inserts (25), Drill (1), Tap (1), Installation Tool - Bolt Style (1)*

## MITSUBISHI

### FX80

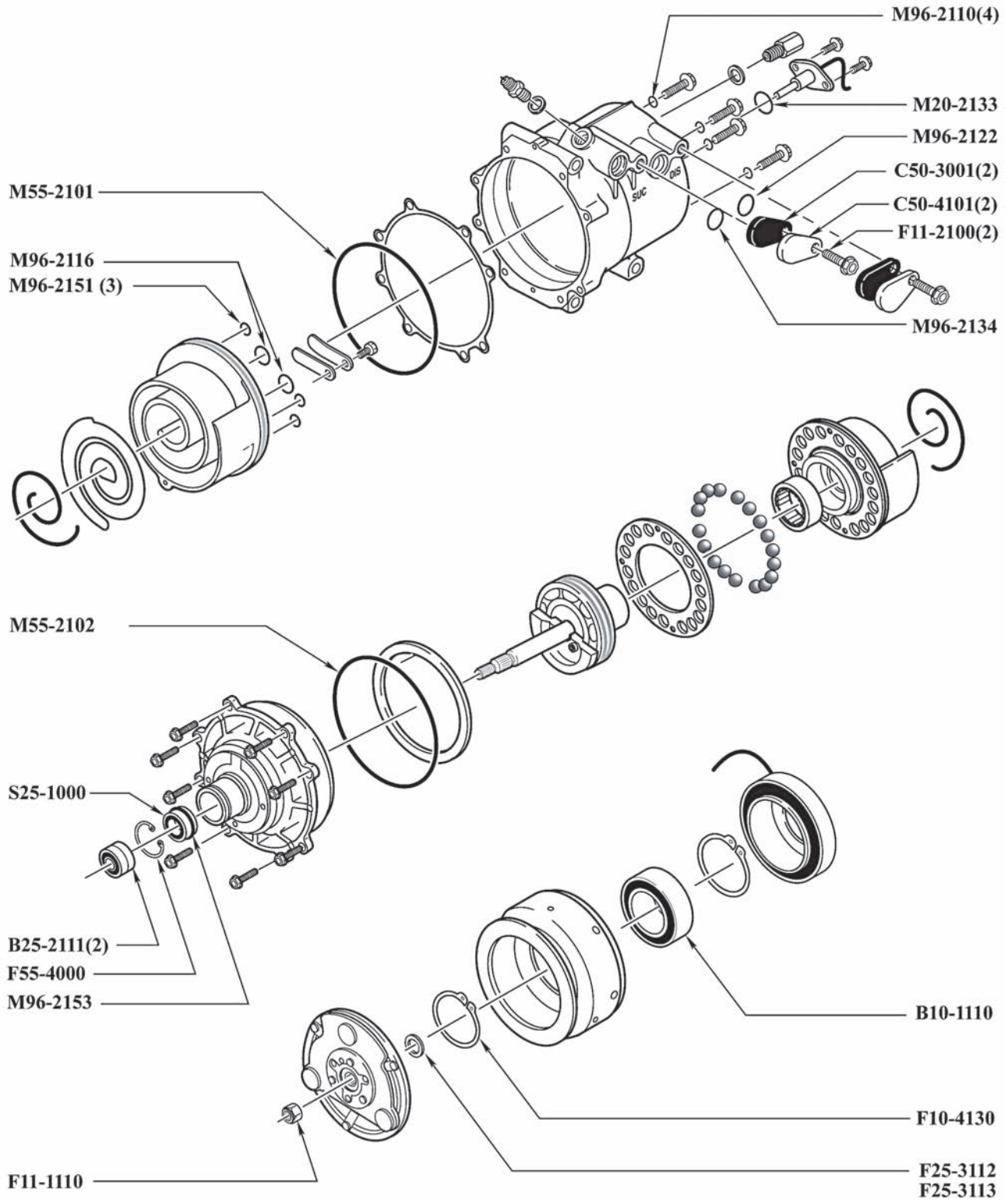

## MITSUBISHI

### FX80

O-Rings	R134a and R-12 Compatible	Green HNBR	Black Nitrile
Case O-Ring		<b>M55-2102</b>	
Discharge Port O-Ring		<b>M96-2122</b>	<b>M96-1022</b>
Lip Seal O-Ring		<b>M96-2153</b>	<b>M96-1053</b>
Rear Head Bolt O-Ring		<b>M96-2110</b>	<b>M96-1010</b>
Rear Housing Body O-Ring		<b>M96-2116</b>	<b>M96-1016</b>
Rear Housing O-Ring		<b>M96-2151</b>	<b>M96-1051</b>
Rear Scroll O-Ring		<b>M55-2101</b>	
Sensor O-Ring		<b>M20-2133</b>	
Suction Port O-Ring		<b>M96-2134</b>	<b>M96-1034</b>

#### Bearings

Nose Bearing (12mm x 28mm x 8mm)	<b>B25-2111</b>
Clutch Bearing (40mm x 62mm x 20.6mm-24mm)	<b>B10-1110</b>

#### Chemicals

Ultra PAG Oil 46 - 6pk, 8 oz Bottle	<b>MT3012</b>
Ultra PAG Oil 46 - 6pk, Quart Bottle	<b>MT3018</b>
Ultra PAG Oil 46 - Drum (52 gal)	<b>A10-6163</b>

#### Fasteners

Bolt - Shipping Plate	<b>F11-2100</b>
Helical Insert - Rear Head / Shipping Plate (8-1.25 x 12mm)	<b>F10-6211</b>
Nut - Shaft	<b>F11-1110</b>
Retaining Ring - Pulley	<b>F10-4130</b>
Retaining Ring - Shaft Seal Seat	<b>F55-4000</b>
Shim - Clutch (0.38mm)	<b>F25-3112</b>
Shim - Clutch (0.76mm)	<b>F25-3113</b>

#### Gaskets

O-Ring Kit	Green HNBR <b>K55-2105</b>
------------	----------------------------



*Includes: Sensor O-Ring (1), Stationary Scroll O-Ring (1), Front Case O-Ring (Outer) (1), Discharge Port O-Ring (1), Suction Port O-Ring (1), Lip Seal Outer O-Ring (1), Head Bolt O-Ring (4)*

#### Service Items

Valve Core - Standard Pressure	<b>A10-1120</b>
--------------------------------	-----------------

#### Shaft Seals

Lip Seal (Black Rubber Coated)	Nitrile <b>S55-1001</b>
Lip Seal (Metal Can)	Nitrile <b>S25-1000</b>

#### Shaft Seals

Lip Seal Kit (Metal Can Seal)	Black Nitrile <b>K55-3110</b>
-------------------------------	-------------------------------



*Includes: Lip Seal Retaining Ring (1), Lip Seal (1)*

Lip Seal Kit (Rubber Coated Seal)	Black Nitrile <b>K55-3006</b>
-----------------------------------	-------------------------------



*Includes: Lip Seal Retaining Ring (1), Lip Seal (1)*

#### Shipping Closures

Cap - 1/4" Low Side	<b>C10-1000</b>
Shipping Pad (Use with C50-4101)	<b>C50-3001</b>
Shipping Plate (Use with C50-3001)	<b>C50-4101</b>
Shipping Plate (Use with C95-3004 & C95-3006)	<b>C95-4001</b>
Shipping Plug (Discharge) (Use with C95-4001)	<b>C95-3004</b>
Shipping Plug (Suction) (Use with C95-4001)	<b>C95-3006</b>

#### Tools

Helical Insert Drill for 8-1.25mm Inserts	<b>T10-6053</b>
Helical Insert Tap 8-1.25mm	<b>T10-6254</b>
Helical Insert Tool 8-1.25mm - Bolt Style	<b>T10-6554</b>
Shaft Seal Protector, Adjustable	<b>T95-1221</b>
Shaft Seal Seat Remover	<b>T55-1033</b>

## MITSUBISHI

### FX105V

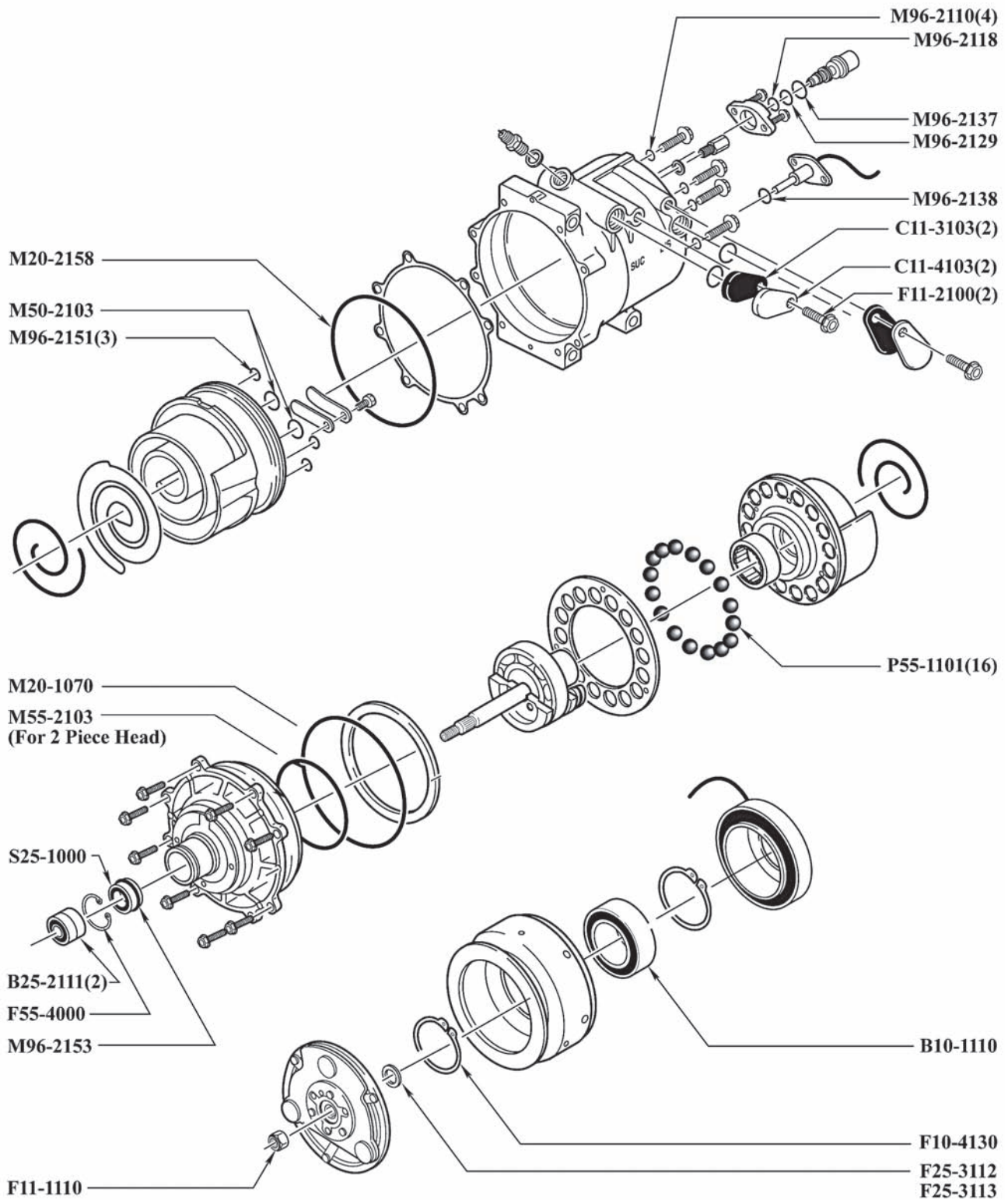

## MITSUBISHI

### FX105V

O-Rings	R134a and R-12 Compatible	Green HNBR	Black Nitrile
Carbon Shaft Seal O-Ring		<b>M65-2115</b>	<b>M65-1015</b>
Case O-Ring			<b>M20-1070</b>
Control Valve O-Ring (Center)		<b>M96-2129</b>	<b>M96-1029</b>
Control Valve O-Ring (Inner)		<b>M96-2118</b>	<b>M96-1018</b>
Control Valve O-Ring (Outer)		<b>M96-2137</b>	<b>M96-1037</b>
Lip Seal O-Ring		<b>M96-2153</b>	<b>M96-1053</b>
Nose Plate O-Ring		<b>M55-2103</b>	<b>M55-1003</b>
Rear Head Bolt O-Ring		<b>M96-2110</b>	<b>M96-1010</b>
Rear Housing Body O-Ring		<b>M50-2103</b>	<b>M50-1003</b>
Rear Housing O-Ring		<b>M96-2151</b>	<b>M96-1051</b>
Rear Scroll Housing O-Ring		<b>M20-2158</b>	<b>M20-1058</b>
Sensor O-Ring		<b>M96-2138</b>	<b>M96-1038</b>
Shaft Seal Seat O-Ring		<b>M30-2100</b>	<b>M30-1000</b>

#### Bearings

Nose Bearing (12mm x 28mm x 8mm)	<b>B25-2111</b>
Clutch Bearing (40mm x 62mm x 20.6mm-24mm)	<b>B10-1110</b>

#### Chemicals

Ultra PAG Oil 46 - 6pk, 8 oz Bottle	<b>MT3012</b>
Ultra PAG Oil 46 - 6pk, Quart Bottle	<b>MT3018</b>
Ultra PAG Oil 46 - Drum (52 gal)	<b>A10-6163</b>

#### Fasteners

Bolt - Shipping Plate	<b>F11-2100</b>
Helical Insert - Rear Head / Shipping Plate (8-1.25 x 12mm)	<b>F10-6211</b>
Nut - Shaft	<b>F11-1110</b>
Retaining Ring - Pulley	<b>F10-4130</b>
Retaining Ring - Shaft Seal Seat	<b>F55-4000</b>
Shim - Clutch (0.38mm)	<b>F25-3112</b>
Shim - Clutch (0.76mm)	<b>F25-3113</b>

#### Gaskets

O-Ring Kit	Black Nitrile <b>K55-2001</b>
------------	-------------------------------

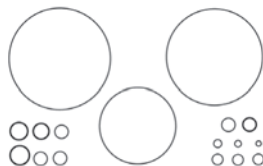

Includes: O-Rings: Front Scroll Housing (1), Control Valve (Inner) (1), Control Valve (Center) (1), Control Valve (Outer) (1), Nose Plate (1), Rear Housing Body (1), Sensor (1), Metal Shaft Seal Seat (1), Case (2), Rear Housing (3), Head Bolt (Rear) (4).

#### Piston Components

Rotor Ball (12.67mm) (16/Unit)	<b>P55-1101</b>
--------------------------------	-----------------

#### Service Items

Valve Core - Standard Pressure	<b>A10-1120</b>
--------------------------------	-----------------

#### Shaft Seals

Carbon Shaft Seal	HNBR <b>S25-2102</b>
Lip Seal (Black Rubber Coated)	Nitrile <b>S55-1001</b>
Lip Seal (Metal Can)	Nitrile <b>S25-1000</b>
Metal Shaft Seal Seat	<b>S25-3102</b>
Carbon Shaft Seal Kit	Green HNBR <b>K55-3105</b>

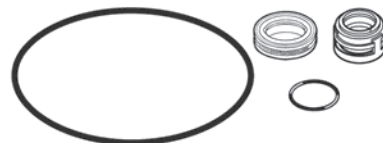

Includes: Carbon Shaft Seal (1), Metal Shaft Seal Seat (1), Nose Plate O-Ring (1), Metal Shaft Seal Seat O-Ring (1)

Lip Seal Kit (Metal Can Seal)	Black Nitrile <b>K55-3110</b>
-------------------------------	-------------------------------



Includes: Lip Seal Retaining Ring (1), Lip Seal (1)

## MITSUBISHI

### FX105V

#### Shaft Seals

Lip Seal Kit (Rubber Coated Seal)      Black Nitrile **K55-3006**



*Includes: Lip Seal Retaining Ring (1), Lip Seal (1)*

#### Shipping Closures

Cap - 1/4" Low Side	<b>C10-1000</b>
Shipping Pad (Use with C11-4103)	<b>C11-3103</b>
Shipping Plate (Use with C11-3103)	<b>C11-4103</b>
Shipping Plate (Use with C95-3004 & C95-3006)	<b>C95-4001</b>
Shipping Plug (Discharge) (Use with C95-4001)	<b>C95-3004</b>
Shipping Plug (Suction) (Use with C95-4001)	<b>C95-3006</b>

#### Tools

Helical Insert Drill for 8-1.25mm Inserts	<b>T10-6053</b>
Helical Insert Tap 8-1.25mm	<b>T10-6254</b>
Helical Insert Tool 8-1.25mm - Bolt Style	<b>T10-6554</b>
Shaft Seal Protector, Adjustable	<b>T95-1221</b>
Shaft Seal Seat Remover	<b>T55-1033</b>
Helical Insert Repair Kit (8-1.25mm)	<b>K10-1180</b>



*Includes: Helical Inserts (25), Drill (1), Tap (1), Installation Tool - Bolt Style (1)*





## MITSUBISHI

AX105VSL, AX105VSR, FXA105VS, FXA105VSLR, FXA105VSR, FXA105VSS, FXA105VSSS

VSSS Unit Only:

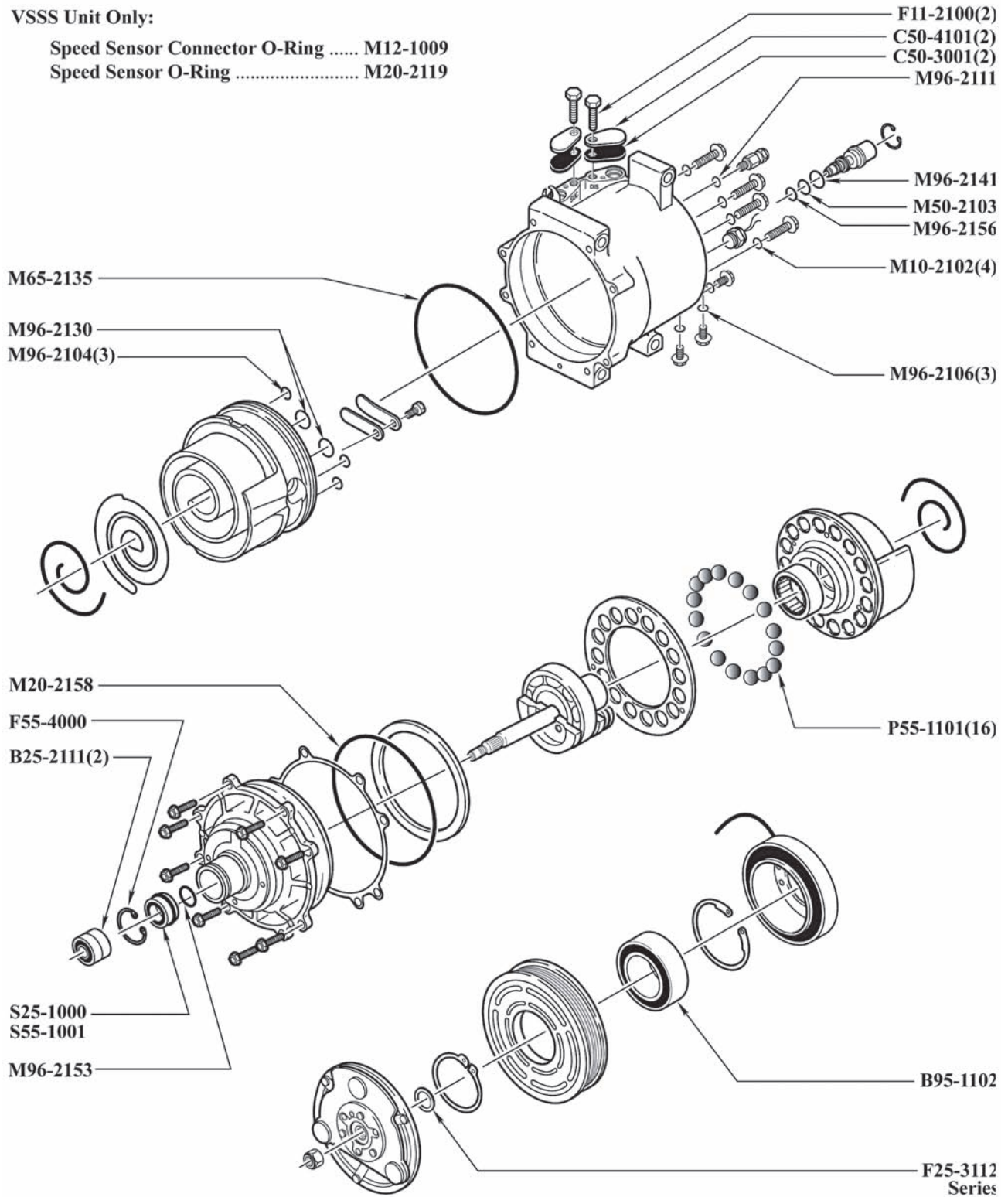

Speed Sensor Connector O-Ring ..... M12-1009

Speed Sensor O-Ring ..... M20-2119



## MITSUBISHI

AX105VSL, AX105VSR, FXA105VS, FXA105VSLR, FXA105VSR, FXA105VSS, FXA105VSSS

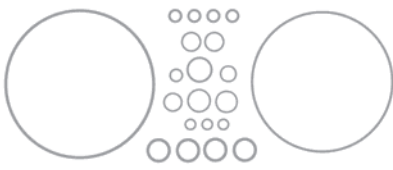
O-Rings	R134a and R-12 Compatible	Green HNBR	Black Nitrile
Case O-Ring		M20-2158	M20-1058
Control Valve Inner O-Ring		M96-2156	
Control Valve Middle O-Ring		M50-2103	M50-1003
Control Valve Outer O-Ring		M96-2141	M96-1041
Lip Seal O-Ring		M96-2153	M96-1053
Outside Bolt Plug O-Ring		M96-2106	
Pressure Relief Valve O-Ring		M96-2111	
Rear Bolt O-Ring		M10-2102	M10-1002
Rear Housing Body O-Ring		M96-2130	
Rear Housing O-Ring		M96-2104	
Rear Scroll O-Ring		M65-2135	M65-1035
Speed Sensor Connector O-Ring (on VSSS unit only)			M12-1009
Speed Sensor O-Ring (on VSSS unit only)		M20-2119	
Bearings		Shaft Seals	
Nose Bearing (12mm x 28mm x 8mm)	B25-2111	Lip Seal Kit (Metal Can Seal)	Black Nitrile K55-3110
Clutch Bearing (40mm x 57mm x 24mm)	B95-1102		
Chemicals		<i>Includes: Lip Seal Retaining Ring (1), Lip Seal (1)</i>	
Ultra PAG Oil 46 - 6pk, 8 oz Bottle	MT3012	Lip Seal Kit (Rubber Coated Seal)	Black Nitrile K55-3006
Ultra PAG Oil 46 - 6pk, Quart Bottle	MT3018		
Ultra PAG Oil 46 - Drum (52 gal)	A10-6163	<i>Includes: Lip Seal Retaining Ring (1), Lip Seal (1)</i>	
Fasteners		Shipping Closures	
Bolt - Shipping Plate	F11-2100	Shipping Pad (Use with C50-4101)	C50-3001
Helical Insert - Rear Head / Shipping Plate (8-1.25 x 12mm)	F10-6211	Shipping Plate (Use with C50-3001)	C50-4101
Retaining Ring - Lip Seal	F55-4000	Tools	
Shim - Clutch (0.38mm)	F25-3112	Helical Insert Drill for 8-1.25mm Inserts	T10-6053
Shim - Clutch (0.76mm)	F25-3113	Helical Insert Tap 8-1.25mm	T10-6254
Gaskets		Helical Insert Tool 8-1.25mm - Bolt Style	T10-6554
O-Ring Kit	Green HNBR K55-2109	Shaft Seal Protector, Adjustable	T95-1221
		Shaft Seal Seat Remover	T55-1033
<i>Includes: O-Rings: Rear Bolt(4), Front Case(1), Rear Case(1), Rear Control Block(3), Outside Bolt Plug(4), Pressure Relief Valve(1), Rear Control Block to Valves(2), Speed Sensor Connector(1), Speed Sensor(1), Control Valve Center(1)/Outer(1)/Inner(1).</i>			
Piston Components			
Rotor Ball (12.67mm) (16/Unit)	P55-1101		
Shaft Seals			
Lip Seal (Black Rubber Coated)	Nitrile S55-1001		
Lip Seal (Metal Can)	Nitrile S25-1000		

## MITSUBISHI

### MSC90, MSC90C

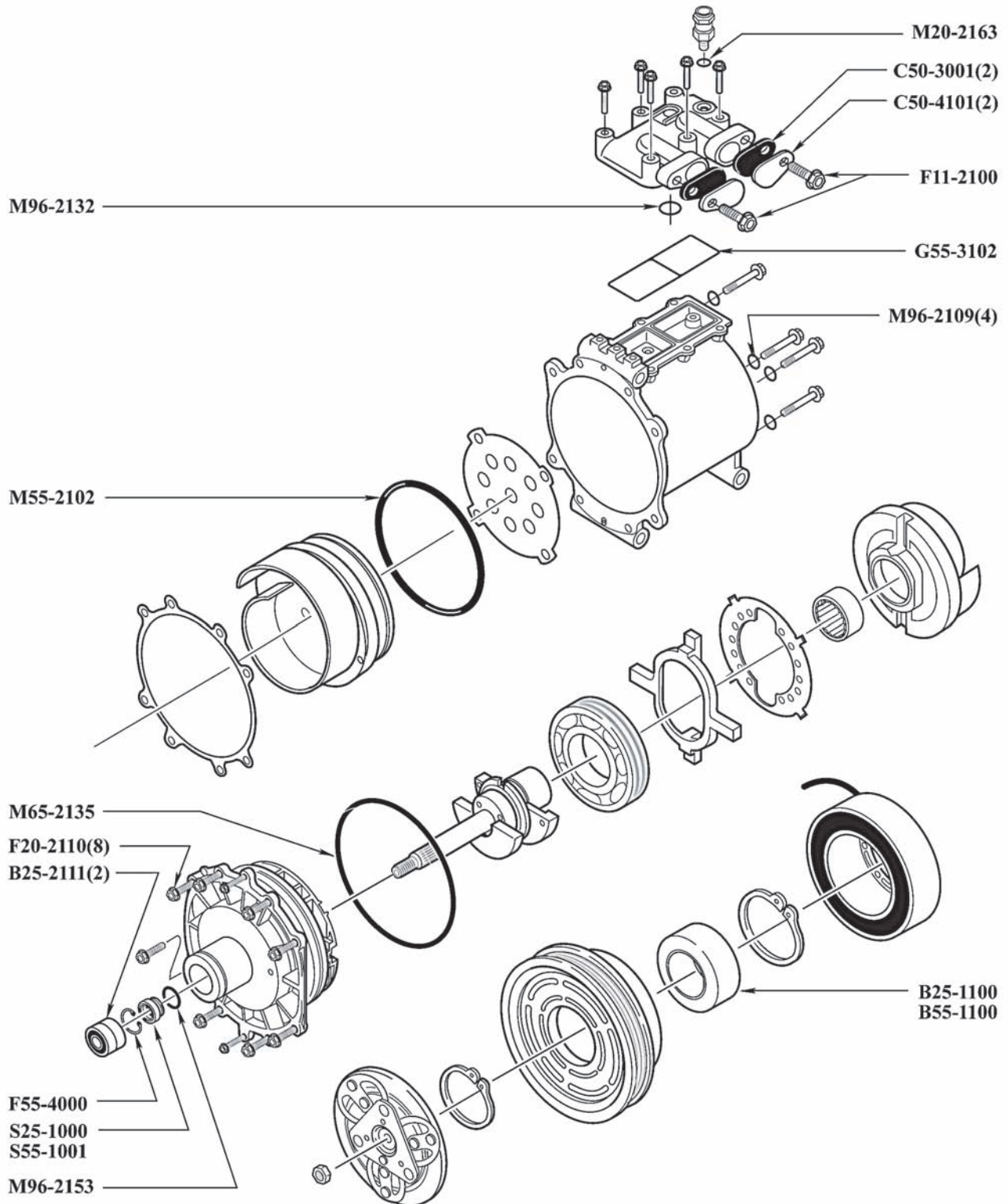

## MITSUBISHI

### MSC90, MSC90C

O-Rings	R134a and R-12 Compatible	Green HNBR	Black Nitrile
Case Bolt O-Ring		<b>M96-2109</b>	<b>M96-1009</b>
Case O-Ring		<b>M65-2135</b>	<b>M65-1035</b>
Lip Seal O-Ring		<b>M96-2153</b>	<b>M96-1053</b>
Pressure Release Valve O-Ring		<b>M20-2163</b>	
Rear Scroll O-Ring		<b>M55-2102</b>	
Temperature Sensor O-Ring		<b>M96-2132</b>	<b>M96-1032</b>

Bearings	
Nose Bearing (12mm x 28mm x 8mm)	<b>B25-2111</b>
Clutch Bearing (40mm x 62mm x 24mm)	<b>B25-1100</b>
Clutch Bearing (40mm x 66mm x 24mm)	<b>B55-1100</b>

Chemicals	
Ultra PAG Oil 46 - 6pk, 8 oz Bottle	<b>MT3012</b>
Ultra PAG Oil 46 - 6pk, Quart Bottle	<b>MT3018</b>
Ultra PAG Oil 46 - Drum (52 gal)	<b>A10-6163</b>

Clutch Components	
Clutch Hub	<b>H55-7000</b>

Fasteners	
Bolt - Front Head	<b>F20-2110</b>
Bolt - Shipping Plate	<b>F11-2100</b>
Helical Insert - Rear Head / Shipping Plate (8-1.25 x 12mm)	<b>F10-6211</b>
Retaining Ring - Shaft Seal Seat	<b>F55-4000</b>

Gaskets	
Gasket - Suction / Discharge Manifold	Green HNBR <b>G55-3102</b>
Gasket Kit	Green HNBR <b>K55-2107</b>

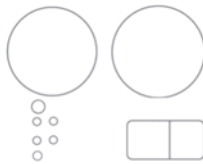

Includes: Suction / Discharge Housing Gasket (1), Pressure Release Valve O-Ring (1), Rear Case O-Ring (1), Front Nose Case O-Ring (1), Case Bolt O-Ring (4), Temperature Sensor O-Ring (1)

Gasket Kit	Black Nitrile <b>K55-2007</b>
------------	-------------------------------

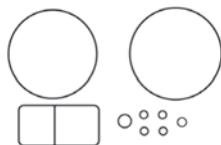

Includes: Suction / Discharge Housing Gasket (1), Pressure Release Valve O-Ring (1), Rear Case O-Ring (1), Front Nose Case O-Ring (1), Case Bolt O-Ring (4), Temperature Sensor O-Ring (1)

Shaft Seals	
Lip Seal (Black Rubber Coated)	Nitrile <b>S55-1001</b>
Lip Seal (Metal Can)	Nitrile <b>S25-1000</b>
Lip Seal Kit (Metal Can Seal)	Black Nitrile <b>K55-3110</b>



Includes: Lip Seal Retaining Ring (1), Lip Seal (1)

Lip Seal Kit (Rubber Coated Seal)	Black Nitrile <b>K55-3006</b>
-----------------------------------	-------------------------------



Includes: Lip Seal Retaining Ring (1), Lip Seal (1)

Shipping Closures	
Shipping Pad (Use with C50-4101)	<b>C50-3001</b>
Shipping Plate (Use with C50-3001)	<b>C50-4101</b>
Shipping Plate (Use with C95-3004 & C95-3006)	<b>C95-4001</b>
Shipping Plug (Discharge) (Use with C95-4001)	<b>C95-3004</b>
Shipping Plug (Suction) (Use with C95-4001)	<b>C95-3006</b>

Tools	
Helical Insert Drill for 8-1.25mm Inserts	<b>T10-6053</b>
Helical Insert Tap 8-1.25mm	<b>T10-6254</b>
Helical Insert Tool 8-1.25mm - Bolt Style	<b>T10-6554</b>
Shaft Seal Protector, Adjustable	<b>T95-1228</b>

## MITSUBISHI

### MSC105CVS, MSC105VSR

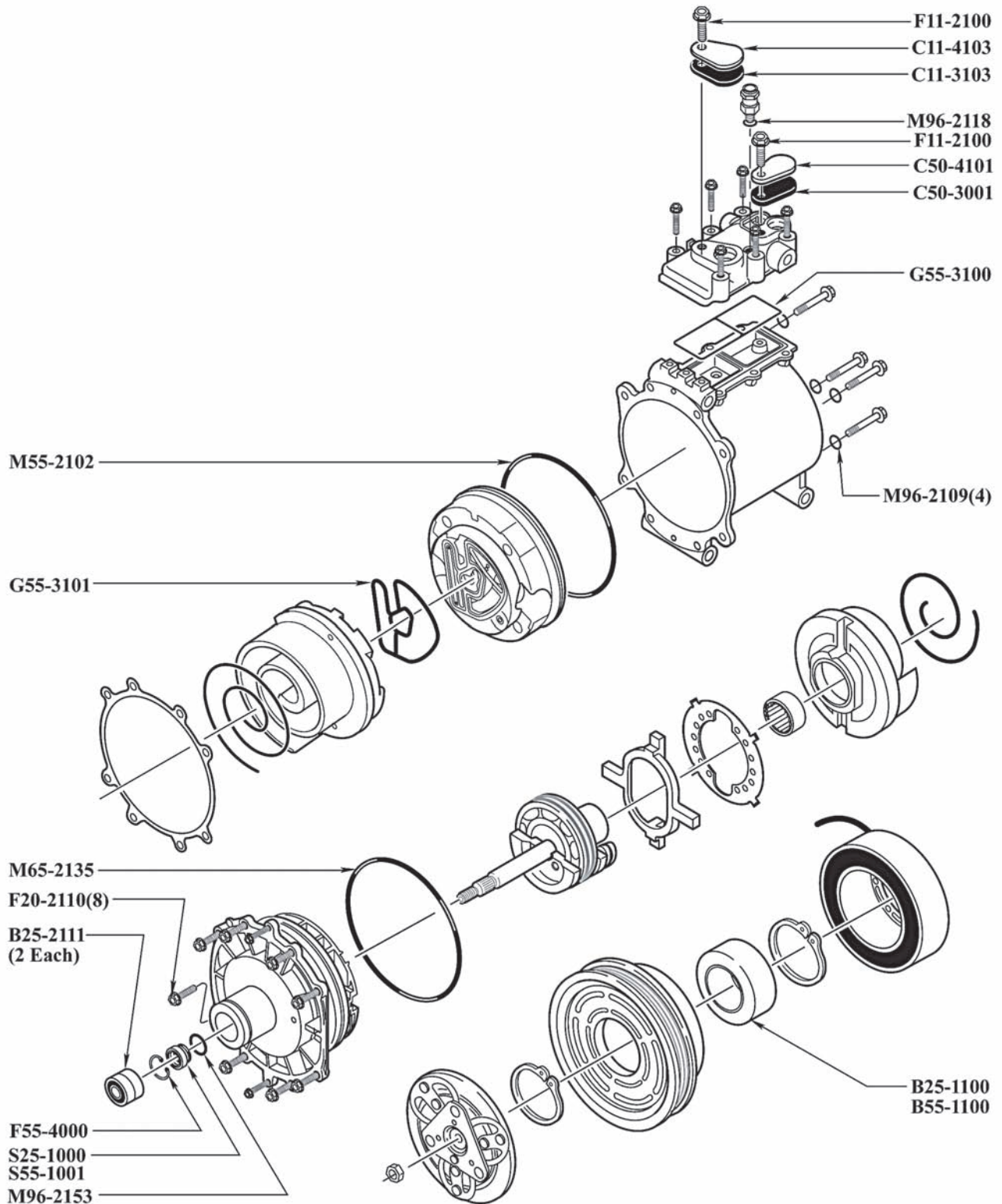

## MITSUBISHI

### MSC105CVS, MSC105VSR

O-Rings	R134a and R-12 Compatible	Green HNBR	Black Nitrile
Case Bolt O-Ring		<b>M96-2109</b>	<b>M96-1009</b>
Case O-Ring (Front)		<b>M65-2135</b>	<b>M65-1035</b>
Case O-Ring (Rear)		<b>M55-2102</b>	
High Pressure Relief Valve O-Ring		<b>M96-2118</b>	<b>M96-1018</b>
Lip Seal O-Ring		<b>M96-2153</b>	<b>M96-1053</b>
Rear Housing Relief Port O-Ring		<b>M50-2110</b>	
Temperature Switch O-Ring		<b>M20-2131</b>	

Bearings	
Nose Bearing (12mm x 28mm x 8mm)	<b>B25-2111</b>
Clutch Bearing (40mm x 62mm x 24mm)	<b>B25-1100</b>
Clutch Bearing (40mm x 66mm x 24mm)	<b>B55-1100</b>

Chemicals	
Ultra PAG Oil 46 - 6pk, 8 oz Bottle	<b>MT3012</b>
Ultra PAG Oil 46 - 6pk, Quart Bottle	<b>MT3018</b>
Ultra PAG Oil 46 - Drum (52 gal)	<b>A10-6163</b>

Fasteners	
Bolt - Front Head	<b>F20-2110</b>
Bolt - Shipping Plate	<b>F11-2100</b>
Helical Insert - Rear Head / Shipping Plate (8-1.25 x 12mm)	<b>F10-6211</b>
Retaining Ring - Lip Seal	<b>F55-4000</b>

Gaskets	
Gasket - Rear Control Housing	Green HNBR <b>G55-3101</b>
Gasket - Suction / Discharge Manifold	Green HNBR <b>G55-3100</b>
Gasket Kit	Green HNBR <b>K55-2106</b>



*Includes: Gaskets: Suction/Discharge Housing(R134a)-Molded (1), Rear Control Housing-Molded (1); O-Rings: Temperature Sensor (1), Rear Housing Relief Port (1), Rear Case (1), Front Case (1), Pressure Relief Valve (1), Case Bolt (4).*

Shaft Seals	
Lip Seal (Black Rubber Coated)	Nitrile <b>S55-1001</b>
Lip Seal (Metal Can)	Nitrile <b>S25-1000</b>

Shaft Seals	
Lip Seal Kit (Metal Can Seal)	Black Nitrile <b>K55-3110</b>



*Includes: Lip Seal Retaining Ring (1), Lip Seal (1)*

Lip Seal Kit (Rubber Coated Seal)	Black Nitrile <b>K55-3006</b>
-----------------------------------	-------------------------------



*Includes: Lip Seal Retaining Ring (1), Lip Seal (1)*

Shipping Closures	
Shipping Pad (Discharge) (Use with C50-4101)	<b>C50-3001</b>
Shipping Pad (Suction) (Use with C11-4103)	<b>C11-3103</b>
Shipping Plate (Discharge) (Use with C50-3001)	<b>C50-4101</b>
Shipping Plate (Suction) (Use with C11-3103)	<b>C11-4103</b>

Tools	
Helical Insert Drill for 8-1.25mm Inserts	<b>T10-6053</b>
Helical Insert Tap 8-1.25mm	<b>T10-6254</b>
Helical Insert Tool 8-1.25mm - Bolt Style	<b>T10-6554</b>
Shaft Seal Protector, Adjustable	<b>T95-1224</b>

## MITSUBISHI

### MSC130CVSG, MSC130CVSG2

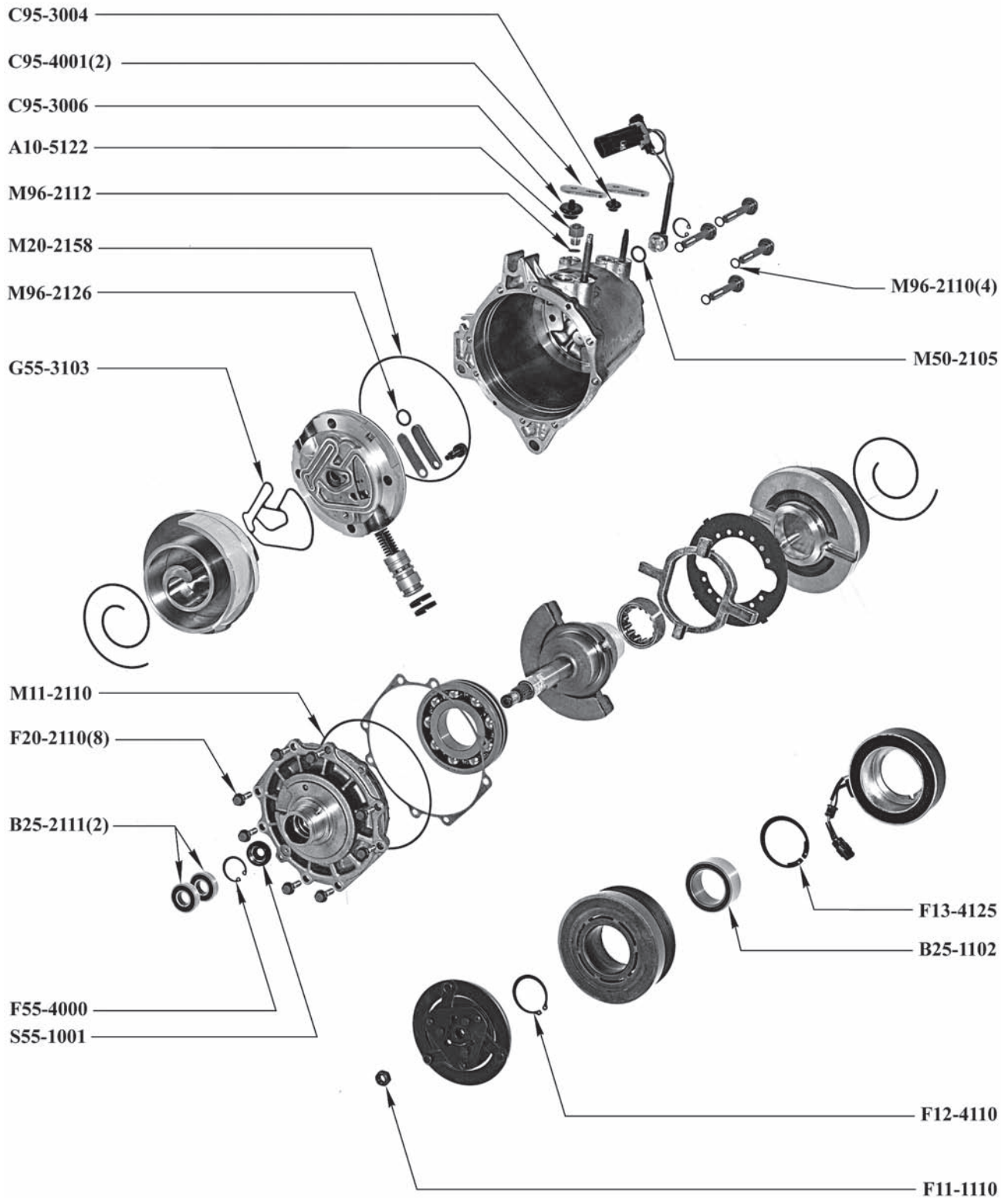



## MITSUBISHI

### MSC130CVSG, MSC130CVSG2

O-Rings	R134a and R-12 Compatible	Green HNBR	Black Nitrile
Case O-Ring (Front)		<b>M11-2110</b>	
Case O-Ring (Rear)		<b>M20-2158</b>	<b>M20-1058</b>
Control Body O-Ring		<b>M96-2126</b>	
O-Ring - Temperature Switch		<b>M50-2105</b>	<b>M50-1005</b>
Pressure Relief Valve O-Ring		<b>M96-2112</b>	
Rear Head Bolt O-Ring		<b>M96-2110</b>	<b>M96-1010</b>

#### Bearings

Nose Bearing (12mm x 28mm x 8mm)	<b>B25-2111</b>
Clutch Bearing (35mm x 50mm x 20mm)	<b>B25-1102</b>

#### Chemicals

Ultra PAG Oil 46 - 6pk, 8 oz Bottle	<b>MT3012</b>
Ultra PAG Oil 46 - 6pk, Quart Bottle	<b>MT3018</b>
Ultra PAG Oil 46 - Drum (52 gal)	<b>A10-6163</b>

#### Fasteners

Bolt - Front Head	<b>F20-2110</b>
Helical Insert - Rear Head / Shipping Plate (8-1.25 x 12mm)	<b>F10-6211</b>
Nut - Shipping Plate / Shaft	<b>F11-1110</b>
Retaining Ring - Clutch Coil (Beveled)	<b>F13-4125</b>
Retaining Ring - Clutch Pulley	<b>F25-4112</b>
Retaining Ring - Lip Seal	<b>F55-4000</b>
Retaining Ring - Pulley	<b>F12-4110</b>

#### Gaskets

Gasket - Scroll Control Body	Green HNBR <b>G55-3103</b>
Gasket Kit	Green HNBR <b>K55-2110</b>



Includes: Front Case O-ring, Rear Case O-Ring, Control Body O-Ring, Temperature Switch O-Ring, PRV O-Ring, Rear Head Bolt O-Ring, Scroll Control Body Gasket

#### Service Items

High Pressure Relief Valve M10x1.25 W/O-ring Non Captive	<b>A10-5122</b>
11mm-Slim-Line Sealing Washer (#8)	<b>A13-1140</b>
17mm-Slim-Line Sealing Washer (#12)	<b>A13-1141</b>

#### Shaft Seals

Lip Seal (Black Rubber Coated)	Nitrile <b>S55-1001</b>
--------------------------------	-------------------------

#### Shaft Seals

Lip Seal Kit (Rubber Coated Seal)	Black Nitrile <b>K55-3006</b>
-----------------------------------	-------------------------------



Includes: Lip Seal Retaining Ring (1), Lip Seal (1)

#### Shipping Closures

Shipping Plate (Use with C95-3004 & C95-3006)	<b>C95-4001</b>
Shipping Plug (Discharge) (Use with C95-4001)	<b>C95-3004</b>
Shipping Plug (Suction) (Use with C95-4001)	<b>C95-3006</b>

#### Tools

Helical Insert Drill for 8-1.25mm Inserts	<b>T10-6053</b>
Helical Insert Tap 8-1.25mm	<b>T10-6254</b>
Helical Insert Tool 8-1.25mm - Bolt Style	<b>T10-6554</b>
Shaft Seal Protector, Adjustable	<b>T95-1221</b>
Shaft Seal Seat Remover	<b>T55-1033</b>
Helical Insert Repair Kit (8-1.25mm)	<b>K10-1180</b>



Includes: Helical Inserts (25), Drill (1), Tap (1), Installation Tool - Bolt Style (1)

## NIHON

### DKV14B

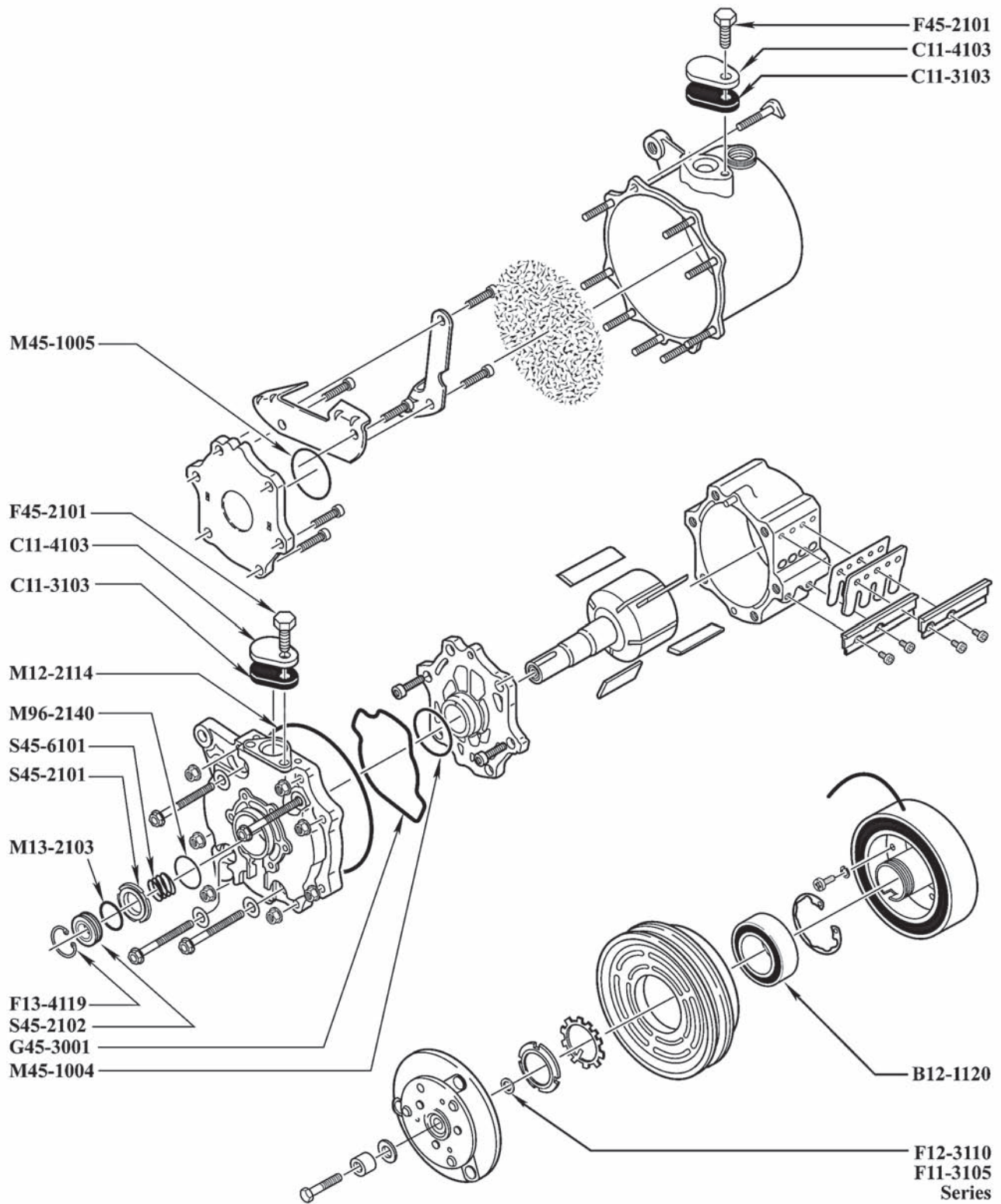

## NIHON

### DKV14B

O-Rings	R134a and R-12 Compatible	Green HNBR	Black Nitrile
Carbon Shaft Seal O-Ring		<b>M96-2140</b>	<b>M96-1040</b>
Case O-Ring		<b>M12-2114</b>	<b>M12-1014</b>
Shaft Seal Seat O-Ring		<b>M13-2103</b>	<b>M13-1003</b>
Valve Body O-Ring (Front)			<b>M45-1004</b>
Valve Body O-Ring (Rear)			<b>M45-1005</b>

Bearings	
Clutch Bearing (30mm x 55mm x 23mm)	<b>B12-1120</b>

Chemicals	
Ultra PAG Oil 100 - 6pk, 8 oz Bottle	<b>MT3013</b>
Ultra PAG Oil 100 - 6pk, Quart Bottle	<b>MT3019</b>
Ultra PAG Oil 100 - Drum (52 gal)	<b>A10-6164</b>

Fasteners	
Bolt - Shipping Plate	<b>F45-2101</b>
Retaining Ring - Shaft Seal Seat	<b>F13-4119</b>
Shim - Clutch (0.20mm)	<b>F11-3105</b>
Shim - Clutch (0.38mm)	<b>F12-3110</b>
Shim - Clutch (0.51mm)	<b>F11-3115</b>

Gaskets	
Gasket - Rotor Body	Black Nitrile <b>G45-3001</b>
Gasket Kit	Black Nitrile <b>K45-2001</b>

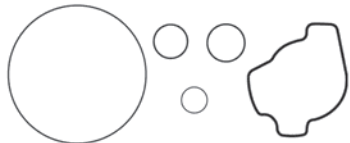

*Includes: Rotor Body Gasket (1), Valve Body O-Ring (Outer) (1), Carbon Shaft Seal O-Ring (1), Metal Shaft Seal Seat O-Ring (1), Case O-Ring (1).*

Shaft Seals	
Carbon Shaft Seal Ring	HNBR <b>S45-2101</b>
Lip Seal	HNBR <b>S45-2102</b>
Shaft Seal Spring	<b>S45-6101</b>
Carbon Shaft Seal Kit	Green HNBR <b>K45-3105</b>



*Includes: Carbon Ring (1), Shaft Seal Spring(1), Carbon Shaft Seal O-Ring (1), Metal Shaft Seal Seat O-Ring (1)*

Shaft Seals	
Lip Seal Kit	Green HNBR <b>K45-3107</b>



*Includes: Lip Seal Retaining Ring (1), Lip Seal (1)*

Shipping Closures	
Shipping Pad (Use with C11-4103)	<b>C11-3103</b>
Shipping Plate (Use with C11-3103)	<b>C11-4103</b>

Tools	
Clutch Puller - Center Hub	<b>T45-1001</b>
Clutch Puller (3 Screw)	<b>T25-1000</b>
Shaft Seal Protector	<b>T30-1000</b>
Spanner Nut Tool	<b>T45-1000</b>

## NIHON DKV14C

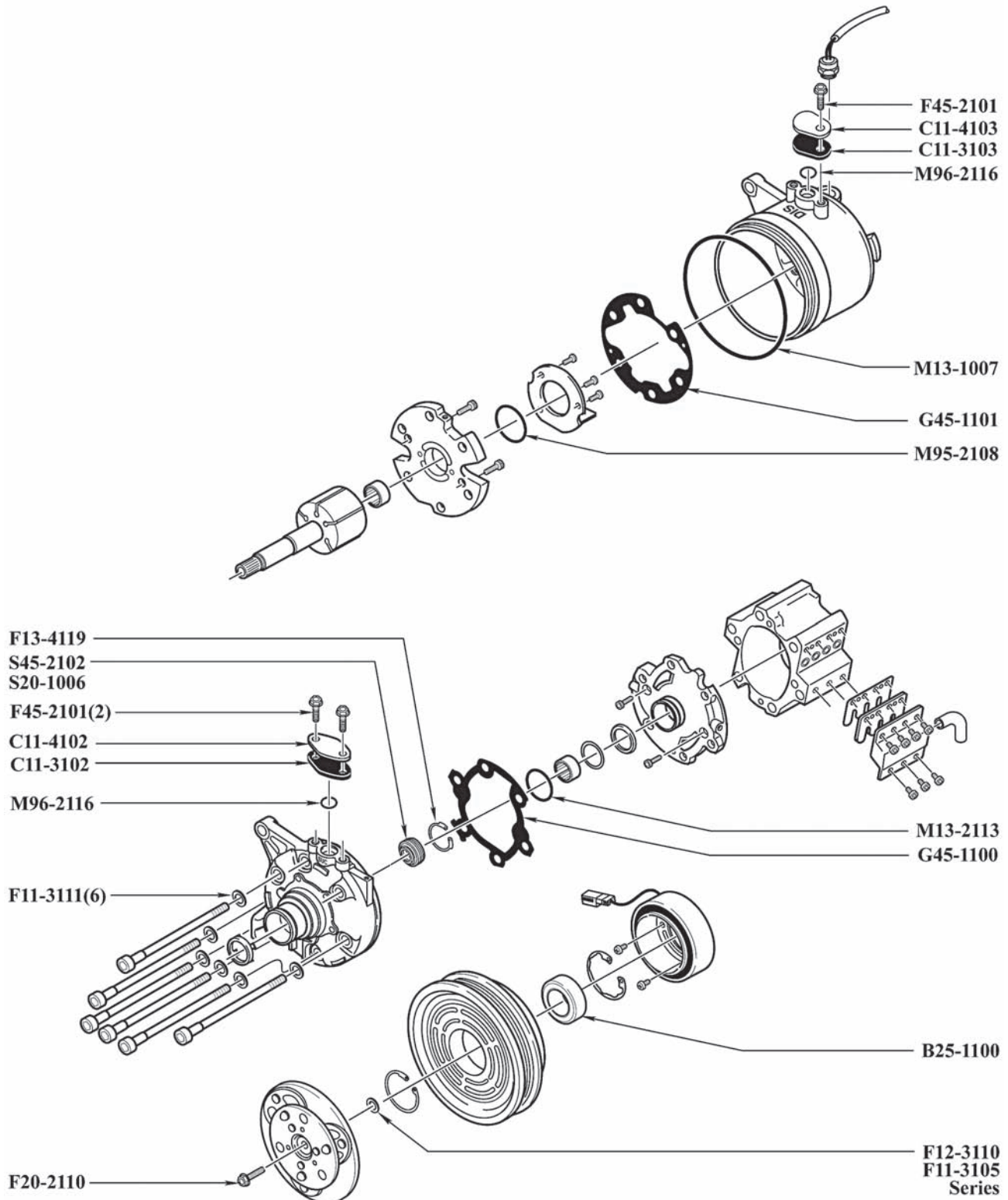

## NIHON

### DKV14C

O-Rings	R134a and R-12 Compatible	Green HNBR	Black Nitrile
Carbon Shaft Seal O-Ring		<b>M96-2134</b>	<b>M96-1034</b>
Case O-Ring		<b>M13-2107</b>	<b>M13-1007</b>
Rotor Body Housing O-Ring (Front)		<b>M13-2113</b>	<b>M13-1013</b>
Rotor Body Housing O-Ring (Rear)		<b>M95-2108</b>	<b>M95-1008</b>
Shaft Seal Seat O-Ring (Large)			<b>M30-1018</b>
Shaft Seal Seat O-Ring (Small)		<b>M30-2100</b>	<b>M30-1000</b>
Suction/Discharge Port O-Ring		<b>M96-2116</b>	<b>M96-1016</b>

#### Bearings

Clutch Bearing (40mm x 62mm x 24mm) **B25-1100**

#### Chemicals

Ultra PAG Oil 100 - 6pk, 8 oz Bottle **MT3013**

Ultra PAG Oil 100 - 6pk, Quart Bottle **MT3019**

Ultra PAG Oil 100 - Drum (52 gal) **A10-6164**

#### Fasteners

Bolt - Shaft **F20-2110**

Bolt - Shipping Plate **F45-2101**

Helical Insert - Rear Head / Shipping Plate (8-1.25 x 12mm) **F10-6211**

Retaining Ring - Lip Seal **F13-4119**

Shim - Clutch (0.20mm) **F11-3105**

Shim - Clutch (0.38mm) **F12-3110**

Shim - Clutch (0.51mm) **F11-3115**

Washer - Head Bolt **F11-3111**

#### Gaskets

Gasket - Front Head Fiber **G45-1100**

Gasket - Rear Head Fiber **G45-1101**

O-Ring Kit Black Nitrile **K45-2002**



*Includes: Large Seat O-Ring (1), Rotor Body Housing O-Ring (Front) (1), Rotor Body Housing O-Ring (Rear) (1), Carbon Shaft Seal O-Ring (1), Small Seat O-Ring (1), Case O-Ring (1)*

#### Shaft Seals

Lip Seal (Black Rubber Coated) HNBR **S20-1006**

Lip Seal (Metal Can) HNBR **S45-2102**

#### Shaft Seals

Lip Seal Kit (Metal Can) Green HNBR **K45-3107**



*Includes: Lip Seal Retaining Ring (1), Lip Seal (1)*

#### Shipping Closures

Shipping Pad (Discharge) (Use with C11-4103) **C11-3103**

Shipping Pad (Suction) (Use with C11-4102) **C11-3102**

Shipping Plate (Discharge) (Use with C11-3103) **C11-4103**

Shipping Plate (Suction) (Use with C11-3102) **C11-4102**

Shipping Plate (Use with C95-3003 & C95-3004) **C95-4002**

Shipping Plug (Discharge) (Use with C95-4002) **C95-3003**

Shipping Plug (Suction) (Use with C95-4002) **C95-3004**

#### Tools

Clutch Puller (3 Screw) **T25-1000**

Helical Insert Drill for 8-1.25mm Inserts **T10-6053**

Helical Insert Tap 8-1.25mm **T10-6254**

Helical Insert Tool 8-1.25mm - Bolt Style **T10-6554**

Shaft Seal Protector **T11-1000**

Shaft Seal Protector, Adjustable **T95-1228**

Helical Insert Repair Kit (8-1.25mm) **K10-1180**



*Includes: Helical Inserts (25), Drill (1), Tap (1), Installation Tool - Bolt Style (1)*

## NIHON NVR140S

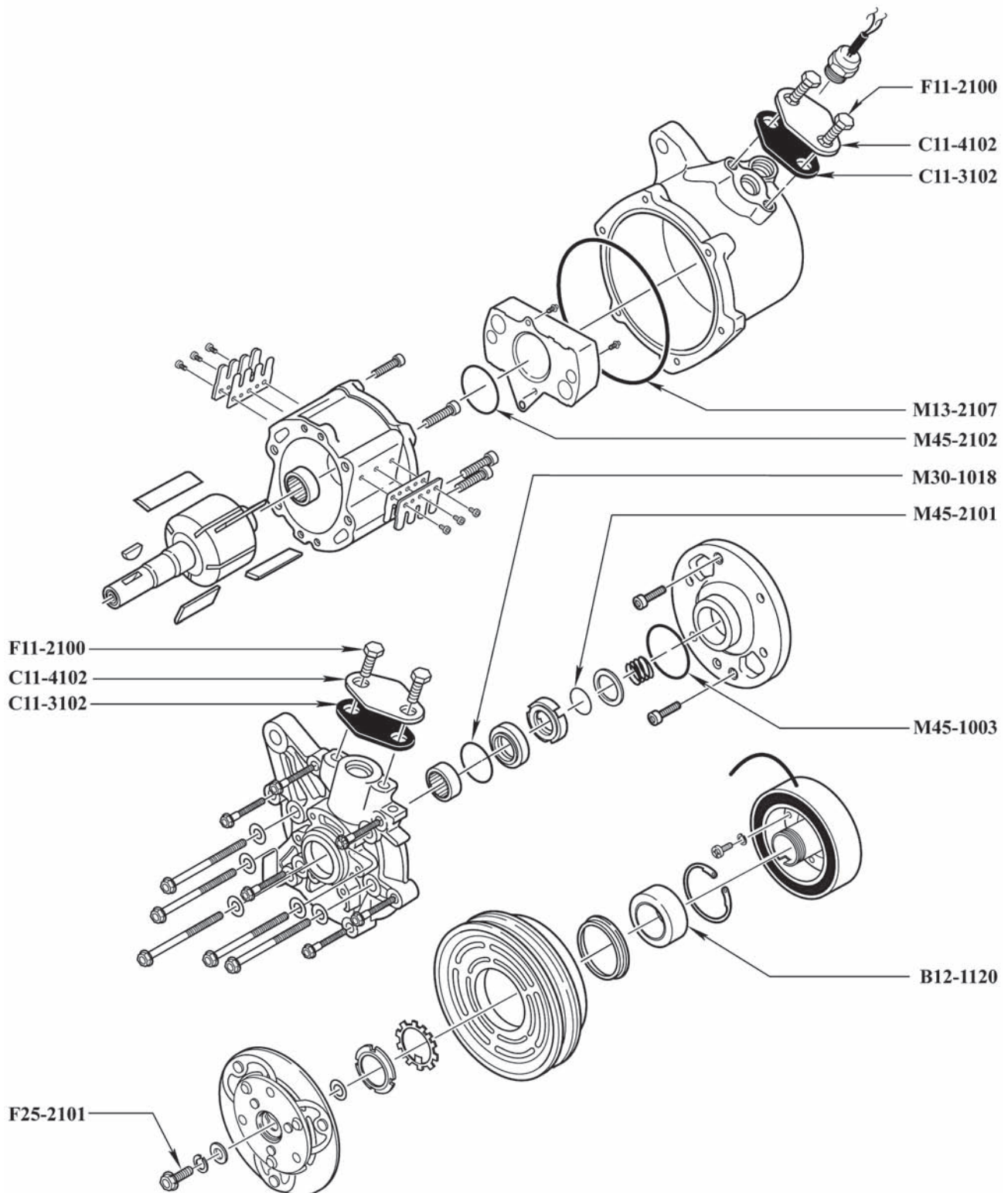

## NIHON

### NVR140S

O-Rings	R134a and R-12 Compatible	Green HNBR	Black Nitrile
Carbon Seal Head O-Ring		<b>M45-2101</b>	<b>M45-1001</b>
Case O-Ring		<b>M13-2107</b>	<b>M13-1007</b>
Front Rotor Body O-Ring			<b>M45-1003</b>
Rear Rotor Body O-Ring		<b>M45-2102</b>	<b>M45-1002</b>
Shaft Seal Seat O-Ring			<b>M30-1018</b>

#### Bearings

Clutch Bearing (30mm x 55mm x 23mm) **B12-1120**

#### Chemicals

Ultra PAG Oil 46 - 6pk, 8 oz Bottle **MT3012**

Ultra PAG Oil 46 - 6pk, Quart Bottle **MT3018**

Ultra PAG Oil 46 - Drum (52 gal) **A10-6163**

#### Fasteners

Bolt - Shaft **F25-2101**

Bolt - Shipping Plate **F11-2100**

Helical Insert - Rear Head / Shipping Plate (8-1.25 x 12mm) **F10-6211**

#### Gaskets

O-Ring Kit **K45-2005** Black Nitrile

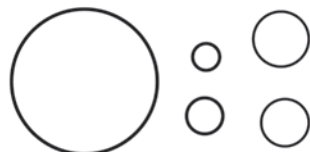

*Includes: Metal Shaft Seal Seat O-Ring (1), Carbon Seal Head O-Ring (1), Rear Rotor Body O-Ring (1), Rear Rotor Body O-Ring (1), Case O-Ring (1)*

#### Shaft Seals

Lip Seal **S45-2102** HNBR

Lip Seal (Requires S45-6002) **S45-1002** Nitrile

Metal Shaft Seal Seat **S45-3000**

Teflon Lip Seal (Requires S45-1002) **S45-6002**

Lip Seal Kit **K45-3106** Green HNBR



*Includes: Lip Seal (1), Teflon Shaft Seal (1)*

#### Shipping Closures

Shipping Pad (Use with C11-4102) **C11-3102**

Shipping Plate (Use with C11-3102) **C11-4102**

Shipping Plate (Use with C95-3003) **C95-4001**

#### Shipping Closures

Shipping Plug (Suction/Disch) (Use with C95-4001) **C95-3003**

#### Tools

Helical Insert Drill for 8-1.25mm Inserts **T10-6053**

Helical Insert Tap 8-1.25mm **T10-6254**

Helical Insert Tool 8-1.25mm - Bolt Style **T10-6554**

Shaft Seal Protector **T30-1000**

Helical Insert Repair Kit (8-1.25mm) **K10-1180**



*Includes: Helical Inserts (25), Drill (1), Tap (1), Installation Tool - Bolt Style (1)*

## SANDEN

### PXE13

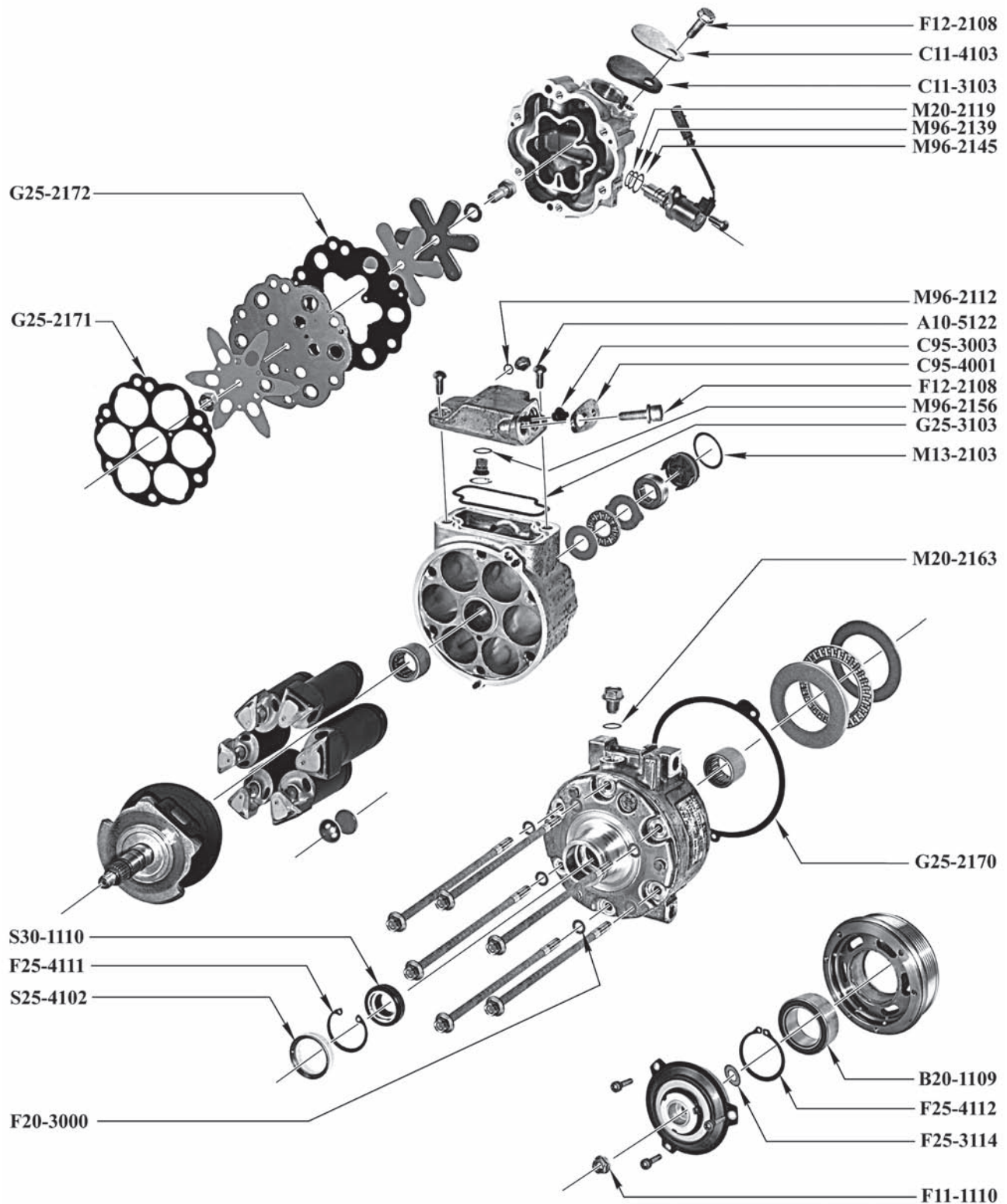



## SANDEN

### PXE13

O-Rings	R134a and R-12 Compatible	Green HNBR	Black Nitrile
Control Valve Inner O-Ring		<b>M20-2119</b>	
Control Valve Middle O-Ring		<b>M96-2139</b>	
Control Valve Outer O-Ring		<b>M96-2145</b>	
Discharge Screen O-Ring		<b>M96-2156</b>	
Oil Drain Bolt O-Ring		<b>M20-2163</b>	
Pressure Relief Valve O-Ring		<b>M96-2112</b>	
Suction Screen O-Ring		<b>M13-2103</b>	<b>M13-1003</b>

#### Bearings

Clutch Bearing (35mm x 52mm x 20mm) **B20-1109**

#### Chemicals

Ultra PAG Oil 46 - 6pk, 8 oz Bottle **MT3012**

Ultra PAG Oil 46 - 6pk, Quart Bottle **MT3018**

Ultra PAG Oil 46 - Drum (52 gal) **A10-6163**

#### Control Valves

O-Ring Kit, Control Valve (3 O-Rings) Green HNBR **K25-2144**



#### Fasteners

Bolt - Shipping Plate **F12-2108**

Helical Insert - Rear Head / Shipping Plate (8-1.25 x 12mm) **F10-6211**

Nut - Shaft **F11-1110**

Retaining Ring - Clutch Pulley **F25-4112**

Retaining Ring - Lip Seal **F25-4111**

Washer - Head Bolt **F20-3000**

Shim - Clutch (0.25mm) **F25-3114**

#### Gaskets

Sanden PXE13 Cylinder Gasket (Metal) Metal **G25-2171**

Sanden PXE13 Front Head Gasket (Metal) Metal **G25-2170**

Sanden PXE13 Rear Head Gasket (Metal) Metal **G25-2172**

Gasket - Discharge Port Green HNBR **G25-3103**

#### Gaskets

Gasket Kit -Metal Green HNBR **K25-2143**



*Includes: Front Head Gasket(1), Cylinder Gasket(1), Rear Head Gasket(1), Manifold Gasket(1), Suction Screen O-Ring(1), Oil Drain Bolt O-Ring(1), PRV O-Ring(1)*

#### Service Items

High Pressure Relief Valve 3/8-24 w/Non-Captive O-Ring **A10-5122**

#### Shaft Seals

Felt Ring **S25-4102**

Lip Seal (Black Rubber Coated) HNBR **S30-1110**

Lip Seal Kit Green HNBR **K30-1110**



*Includes: Lip Seal Retaining Ring (1), Lip Seal Metal Spacer (1), Lip Seal (1)*

#### Shipping Closures

Shipping Pad (Suction) (Use with C11-4103) **C11-3103**

Shipping Plate (Suction) (Use with C11-3103) **C11-4103**

Shipping Plate (Discharge) (Use with C95-3003) **C95-4001**

Shipping Plug (Discharge) (Use with C95-4001) **C95-3003**

#### Tools

Helical Insert Drill for 8-1.25mm Inserts **T10-6053**

Helical Insert Tap 8-1.25mm **T10-6254**

Helical Insert Tool 8-1.25mm - Bolt Style **T10-6554**

## SANDEN

### PXE13

#### Tools

Shaft Seal Protector, Adjustable	<b>T95-1230</b>
Helical Insert Repair Kit (8-1.25mm)	<b>K10-1180</b>



*Includes: Helical Inserts (25), Drill (1), Tap (1), Installation Tool - Bolt Style (1)*



## SANDEN

### PXE16

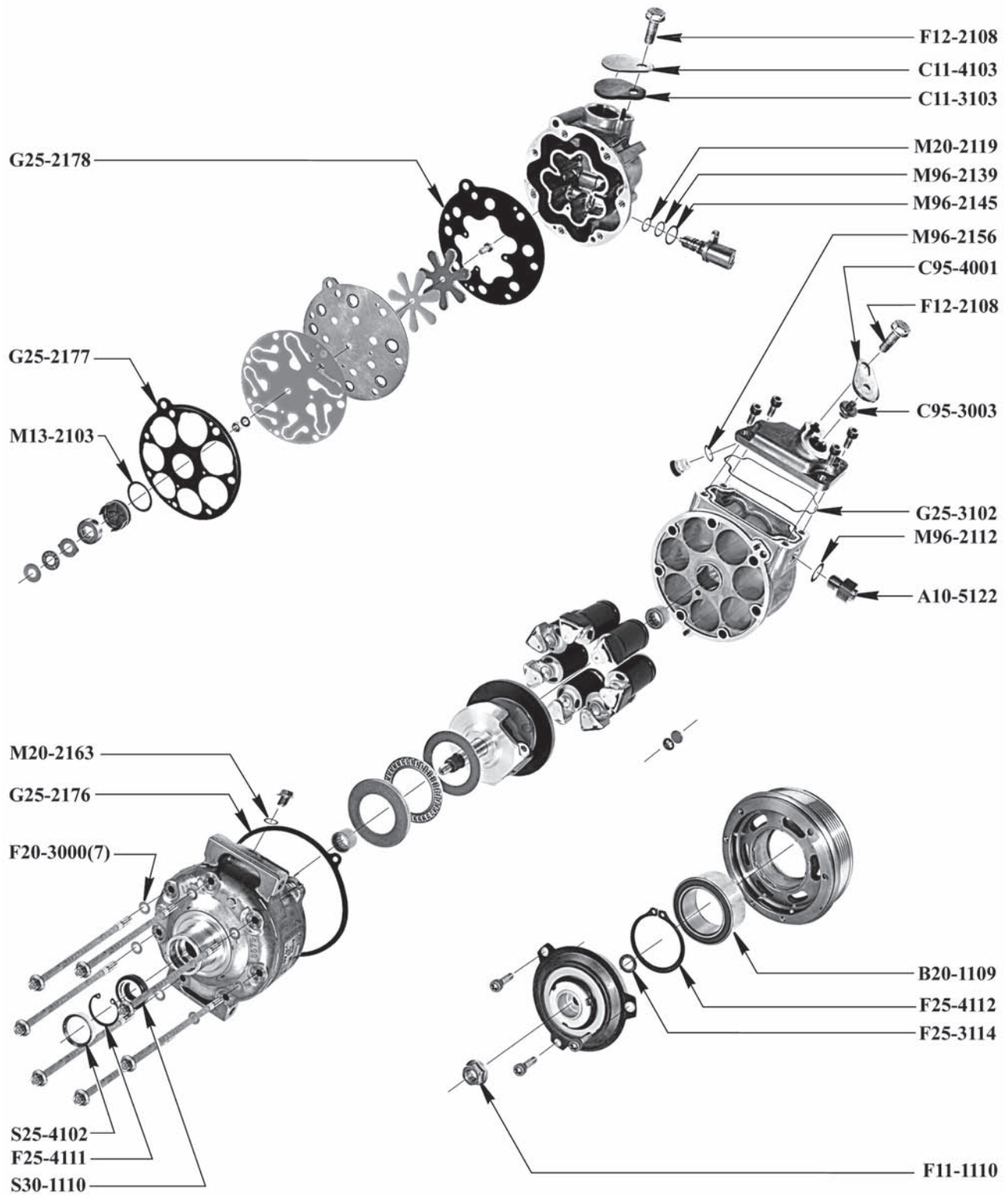

## SANDEN

### PXE16

O-Rings	R134a and R-12 Compatible	Green HNBR	Black Nitrile
Control Valve Inner O-Ring		<b>M20-2119</b>	
Control Valve Middle O-Ring		<b>M96-2139</b>	
Control Valve Outer O-Ring		<b>M96-2145</b>	
Discharge Screen O-Ring		<b>M96-2156</b>	
Oil Drain Bolt O-Ring		<b>M20-2163</b>	
Pressure Relief Valve O-Ring		<b>M96-2112</b>	
Screen O-Ring		<b>M13-2103</b>	<b>M13-1003</b>

#### Bearings

Case Bearing (16.3mm x 22mm x 16mm)	<b>B11-2110</b>
Clutch Bearing (35mm x 52mm x 20mm)	<b>B20-1109</b>

#### Chemicals

Ultra PAG Oil 46 - 6pk, 8 oz Bottle	<b>MT3012</b>
Ultra PAG Oil 46 - 6pk, Quart Bottle	<b>MT3018</b>
Ultra PAG Oil 46 - Drum (52 gal)	<b>A10-6163</b>

#### Control Valves

O-Ring Kit, Control Valve (3 O-Rings)	Green HNBR <b>K25-2144</b>
---------------------------------------	----------------------------



#### Fasteners

Bolt - Shipping Plate	<b>F12-2108</b>
Helical Insert - Rear Head / Shipping Plate (8-1.25 x 12mm)	<b>F10-6211</b>
Nut - Shaft	<b>F11-1110</b>
Retaining Ring - Clutch Pulley	<b>F25-4112</b>
Retaining Ring - Lip Seal	<b>F25-4111</b>
Washer - Head Bolt	<b>F20-3000</b>
Shim - Clutch (0.25mm)	<b>F25-3114</b>

#### Gaskets

Sanden PXE16 Cylinder Gasket (Metal)	Metal <b>G25-2177</b>
Sanden PXE16 Front Head Gasket (Metal)	Metal <b>G25-2176</b>
Sanden PXE16 Rear Head Gasket (Metal)	Metal <b>G25-2178</b>
Gasket - Discharge Port	Green HNBR <b>G25-3102</b>

#### Gaskets

Gasket Kit - Metal Green HNBR **K25-2146**

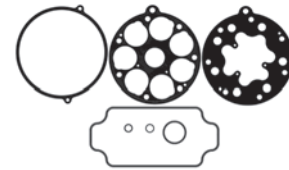

*Includes: Front Head Gasket(1), Cylinder Gasket(1), Rear Head Gasket(1), Manifold Gasket(1), Suction Screen O-Ring(1), Oil Drain Bolt O-Ring(1), PRV O-Ring(1)*

#### Service Items

High Pressure Relief Valve 3/8-24 w/Non-Captive O-Ring **A10-5122**

#### Shaft Seals

Felt Ring	<b>S25-4102</b>
Lip Seal (Black Rubber Coated)	HNBR <b>S30-1110</b>
Lip Seal Kit	Green HNBR <b>K30-1110</b>



*Includes: Lip Seal Retaining Ring (1), Lip Seal Metal Spacer (1), Lip Seal (1)*

#### Shipping Closures

Shipping Pad (Suction) (Use with C11-4103)	<b>C11-3103</b>
Shipping Plate (Suction) (Use with C11-3103)	<b>C11-4103</b>
Shipping Plate (Discharge) (Use with C95-3003)	<b>C95-4001</b>
Shipping Plug (Discharge) (Use with C95-4001)	<b>C95-3003</b>

#### Tools

Helical Insert Drill for 8-1.25mm Inserts	<b>T10-6053</b>
Helical Insert Tap 8-1.25mm	<b>T10-6254</b>
Helical Insert Tool 8-1.25mm - Bolt Style	<b>T10-6554</b>

## SANDEN

### PXE16

#### Tools

Shaft Seal Protector, Adjustable	<b>T95-1230</b>
Helical Insert Repair Kit (8-1.25mm)	<b>K10-1180</b>



*Includes: Helical Inserts (25), Drill (1), Tap (1), Installation Tool - Bolt Style (1)*



## SANDEN

### PXV16

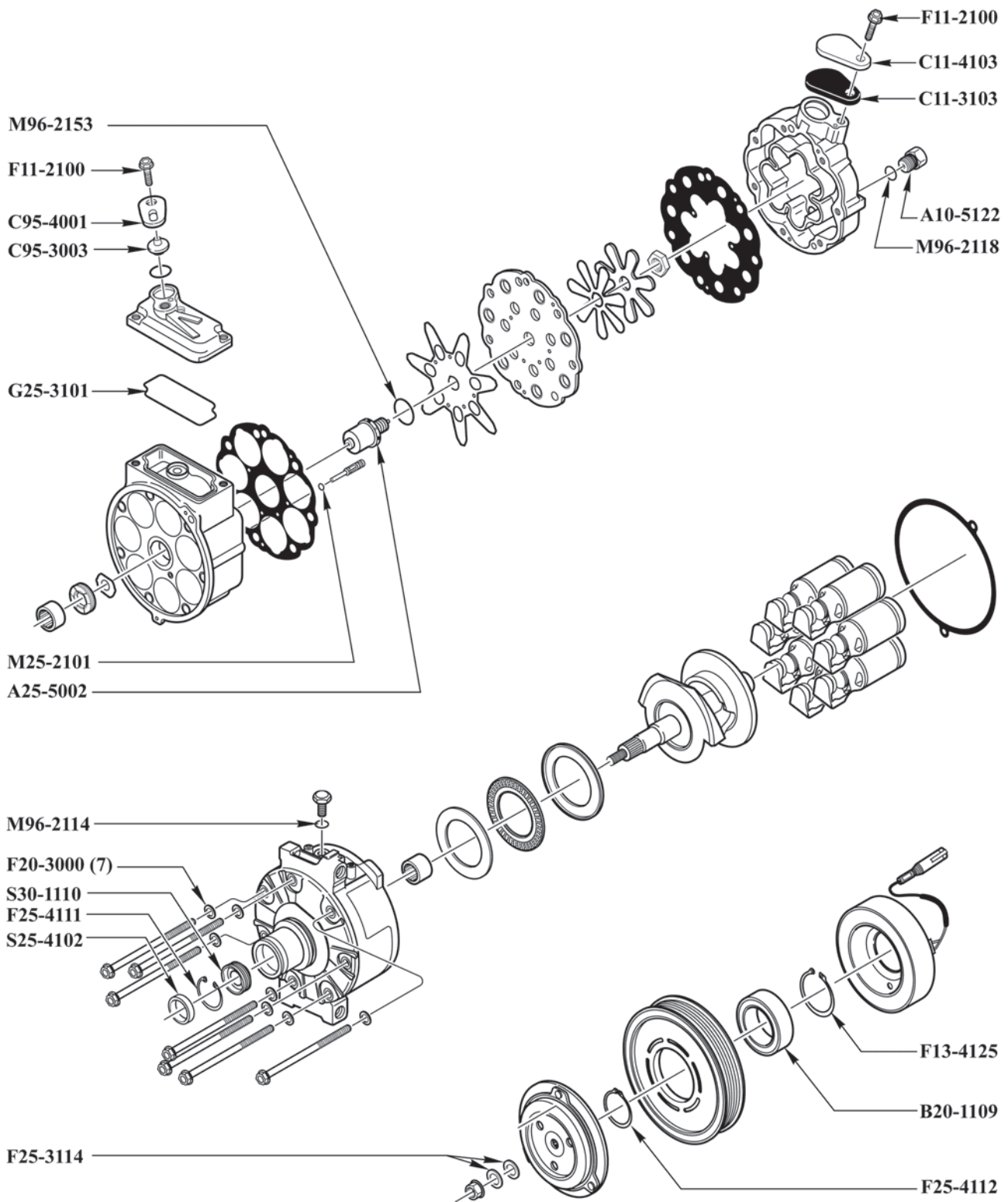



## SANDEN

### PXV16

O-Rings	R134a and R-12 Compatible	Green HNBR	Black Nitrile
Control Valve O-Ring		<b>M96-2153</b>	<b>M96-1053</b>
High Pressure Relief Valve O-Ring		<b>M96-2118</b>	<b>M96-1018</b>
Internal Orifice Tube O-Ring		<b>M25-2101</b>	<b>M25-1001</b>
Oil Drain Plug O-Ring		<b>M96-2114</b>	
<b>Bearings</b>		<b>Shipping Closures</b>	
Case Bearing (16.3mm x 22mm x 16mm)	<b>B11-2110</b>	Shipping Plate (Discharge) (Use with C95-3003)	<b>C95-4001</b>
Clutch Bearing (35mm x 52mm x 20mm)	<b>B20-1109</b>	Shipping Plug (Discharge) (Use with C95-4001)	<b>C95-3003</b>
<b>Clutch Components</b>		<b>Tools</b>	
Clutch Coil - OD/ID: 101mm / 66mm	<b>H25-7388</b>	Helical Insert Drill for 8-1.25mm Inserts	<b>T10-6053</b>
Clutch Coil - OD/ID: 96mm / 61mm	<b>H25-7304</b>	Helical Insert Tap 8-1.25mm	<b>T10-6254</b>
Clutch Hub (24 Spline) - OD: 105mm (Volkswagen)	<b>H25-7066</b>	Helical Insert Tool 8-1.25mm - Bolt Style	<b>T10-6554</b>
<b>Control Valves</b>		Shaft Seal Protector, Adjustable	<b>T95-1227</b>
Internal Control Valve	<b>A25-5002</b>	Helical Insert Repair Kit (8-1.25mm)	<b>K10-1180</b>
<b>Fasteners</b>			
Bolt - Shipping Plate	<b>F11-2100</b>	<i>Includes: Helical Inserts (25), Drill (1), Tap (1), Installation Tool - Bolt Style (1)</i>	
Helical Insert - Rear Head / Shipping Plate (8-1.25 x 12mm)	<b>F10-6211</b>		
Retaining Ring - Clutch Coil (Beveled)	<b>F13-4125</b>		
Retaining Ring - Lip Seal	<b>F25-4111</b>		
Retaining Ring - Pulley	<b>F25-4112</b>		
Washer - Head Bolt	<b>F20-3000</b>		
Shim - Clutch (0.25mm)	<b>F25-3114</b>		
<b>Gaskets</b>			
Gasket - Discharge Port	Green HNBR <b>G25-3101</b>		
<b>Service Items</b>			
High Pressure Relief Valve 3/8-24 w/Non-Captive O-Ring	<b>A10-5122</b>		
<b>Shaft Seals</b>			
Felt Ring	<b>S25-4102</b>		
Lip Seal (Black Rubber Coated)	HNBR <b>S30-1110</b>		
Lip Seal Kit	Green HNBR <b>K30-1110</b>		



*Includes: Lip Seal Retaining Ring (1), Lip Seal Metal Spacer (1), Lip Seal (1)*

### Shipping Closures

Shipping Pad (Suction) (Use with C11-4103)	<b>C11-3103</b>
Shipping Plate (Suction) (Use with C11-3103)	<b>C11-4103</b>

## SANDEN

### SD505

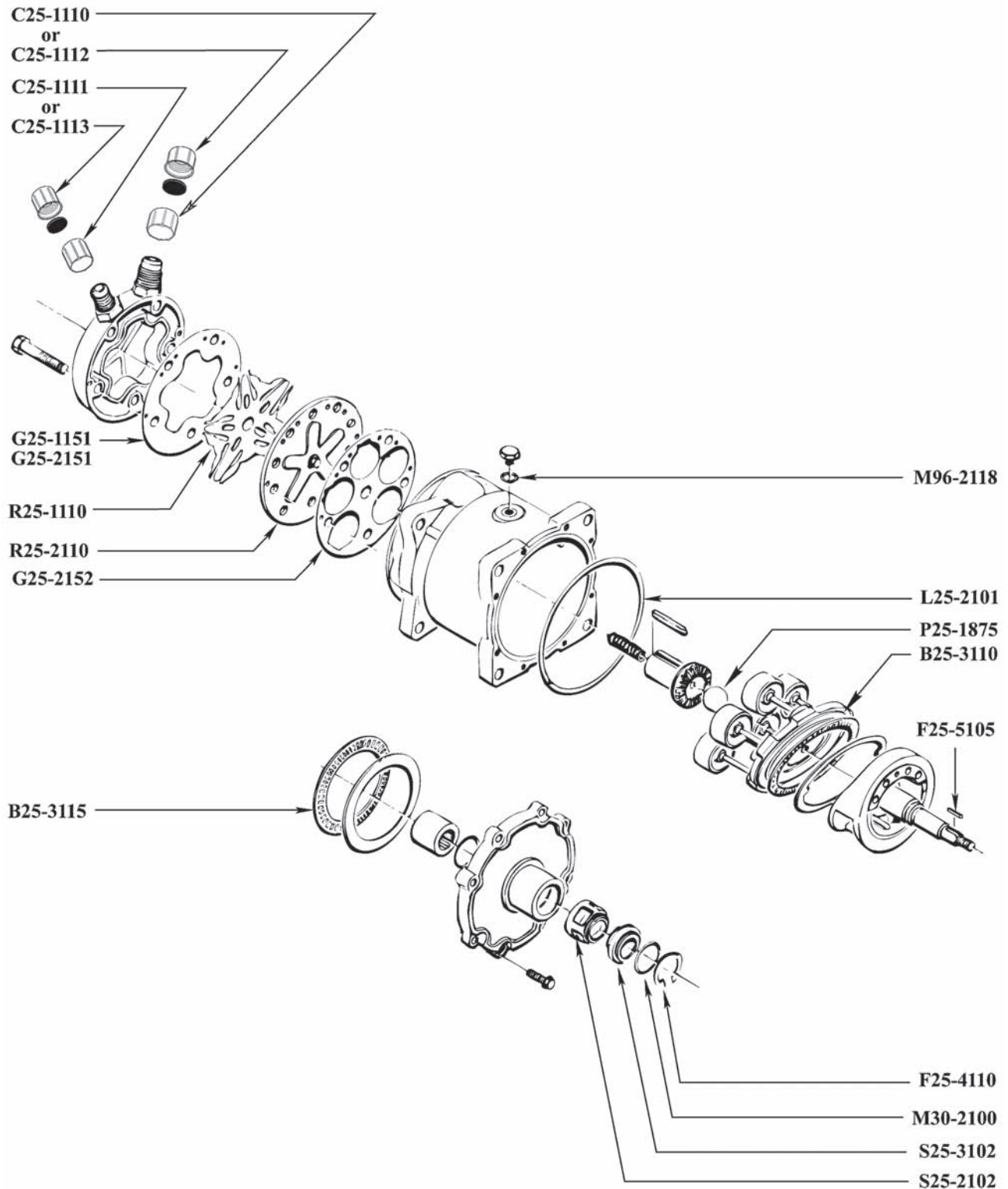

## SANDEN

### SD505

O-Rings and Lathe Cuts	R134a and R-12 Compatible	Green HNBR	Black Nitrile
Carbon Shaft Seal O-Ring		<b>M65-2115</b>	<b>M65-1015</b>
Case Lathe Cut Seal		<b>L25-2101</b>	<b>L25-1001</b>
Oil Drain Plug / Service Port O-Ring		<b>M96-2118</b>	<b>M96-1018</b>
Pad Mount Discharge O-Ring		<b>M96-2138</b>	<b>M96-1038</b>
Pad Mount Suction O-Ring		<b>M96-2153</b>	<b>M96-1053</b>
Shaft Seal Seat O-Ring		<b>M30-2100</b>	<b>M30-1000</b>

#### Bearings

Clutch Bearing (35mm x 55mm x 20mm)	<b>B10-1107</b>
Thrust Bearing (Front) (70.2mm x 89.7mm x 3.2mm)	<b>B25-3115</b>
Thrust Bearing (Rear) (57.2mm x 79.4mm x 3.2mm)	<b>B25-3110</b>

#### Chemicals

Ultra PAG Oil 100 - 6pk, 8 oz Bottle	<b>MT3013</b>
Ultra PAG Oil 100 - 6pk, Quart Bottle	<b>MT3019</b>
Ultra PAG Oil 100 - Drum (52 gal)	<b>A10-6164</b>

#### Fasteners

Shaft Key	<b>F25-5105</b>
Retaining Ring - Coil (1.98mm)	<b>F10-4120</b>
Retaining Ring - Pulley	<b>F10-4130</b>
Retaining Ring - Pulley	<b>F25-4112</b>
Retaining Ring (Beveled) - Shaft Seal Seat	<b>F25-4110</b>
Shim (Notched) - Clutch (0.13mm)	<b>F25-3106</b>
Shim (Notched) - Clutch (0.51mm)	<b>F25-3107</b>

#### Gaskets

Gasket - Head	Fiber <b>G25-1151</b>
Gasket - Cylinder	Metal <b>G25-2152</b>
Gasket - Head	Metal <b>G25-2151</b>
Gasket Kit	Metal <b>K25-2117</b>



Includes: Head Gasket (Metal) (1), Cylinder Gasket (Metal) (1)

#### Gaskets

Gasket Kit (Metal) Green HNBR **K25-2110**

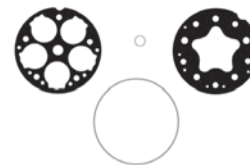

Includes: Head Gasket (Metal) (1), Cylinder Gasket (1), Case Lathe Cut Seal (1), Oil Plug O-Ring / Service Port O-Ring (Universal) (1)

Gasket Kit (Metal) Black Nitrile **K25-2010**



Includes: Head Gasket (Metal) (1), Cylinder Gasket (1), Case Lathe Cut Seal (1), Oil Plug O-Ring / Service Port O-Ring (Universal) (1)

#### Piston Components

Centering Ball (22.23mm) **P25-1875**

#### Reeds and Valve Plates

Reed - Discharge Valve **R25-2110**

Reed - Suction Valve **R25-1110**

#### Service Items

Fitting (Refrigerant) - Flare to Tube Adapter - #10 **A10-5104**

Fitting (Refrigerant) - Flare to Tube Adapter - #8 **A10-5103**

Fitting (Refrigerant) - 1/8-28 UNF w/Valve/O-Ring **A10-1025**

#### Shaft Seals

Carbon Shaft Seal HNBR **S25-2102**

Felt Ring **S25-4101**

Metal Shaft Seal Seat **S25-3102**

## SANDEN

### SD505

#### Shaft Seals

Carbon Shaft Seal Kit

Green HNBR **K25-3110**



*Includes: Carbon Shaft Seal (1), Mini Metal Shaft Seal Seat (1), Metal Shaft Seal Seat O-Ring (1)*

#### Shipping Closures

Discharge Cap w/ Disc - 1" Height	<b>C25-1113</b>
Discharge Cap w/ Disc - 7/9" (.701") Height	<b>C25-1111</b>
Suction Cap w/ O-Ring - 4/5" (.800") Height	<b>C25-1112</b>
Suction Cap w/ O-Ring - 5/8" (.625") Height	<b>C25-1110</b>

#### Tools

Clutch Puller (3 Screw)	<b>T25-1000</b>
Sanden SD505, Clutch Pulley Removal Jaws	<b>LD99-1076</b>
Shaft Seal Installer / Remover	<b>T25-1030</b>
Shaft Seal Protector	<b>T25-1036</b>
Shaft Seal Protector, Adjustable	<b>T95-1227</b>



## SANDEN

SD507, SD507A2, SD508, SD510

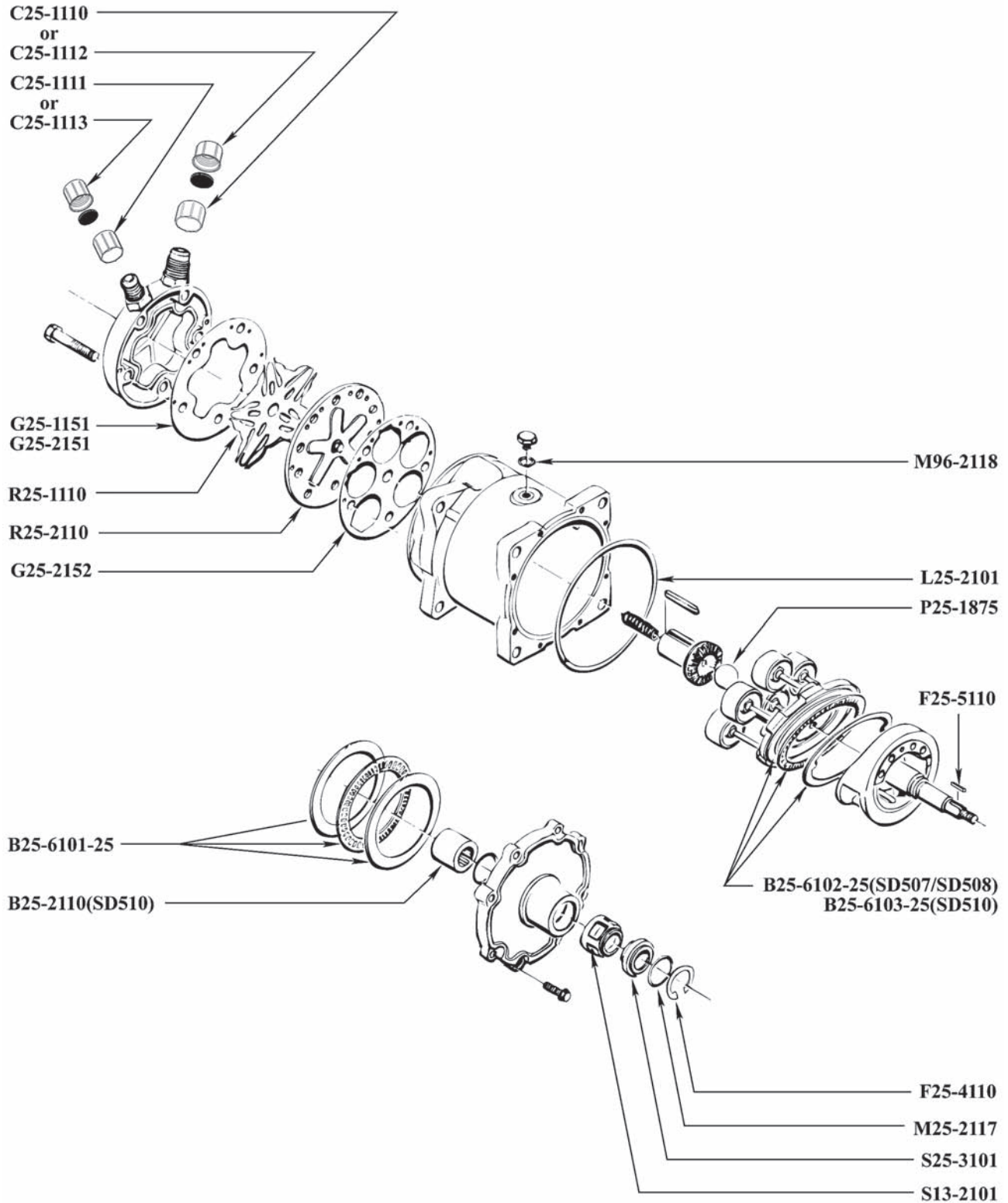

## SANDEN

SD507, SD507A2, SD508, SD510

O-Rings and Lathe Cuts	R134a and R-12 Compatible	Green HNBR	Black Nitrile
Carbon Shaft Seal O-Ring		<b>M96-2134</b>	<b>M96-1034</b>
Case Lathe Cut Seal		<b>L25-2101</b>	<b>L25-1001</b>
Oil Drain Plug / Service Port O-Ring		<b>M96-2118</b>	<b>M96-1018</b>
Pad Mount Discharge O-Ring		<b>M96-2138</b>	<b>M96-1038</b>
Pad Mount Suction O-Ring		<b>M96-2153</b>	<b>M96-1053</b>
Shaft Seal Seat O-Ring		<b>M25-2117</b>	<b>M25-1017</b>

Bearings	
Case Bearing (20mm x 27.1mm x 30mm) (SD510)	<b>B25-2110</b>
Clutch Bearing (40mm x 57mm x 24mm)	<b>B95-1102</b>
Clutch Bearing (40mm x 62mm x 24mm)	<b>B25-1100</b>
Bearing Pack (Front)	<b>B25-6101-25</b>
Bearing Pack (Rear) (SD507/SD508)	<b>B25-6102-25</b>
Bearing Pack (Rear) (SD510)	<b>B25-6103-25</b>
Thrust Bearing (Front) (70.2mm x 89.7mm x 3.2mm)	<b>B25-3115</b>
Thrust Bearing (Rear) (57.2mm x 79.4mm x 3.2mm)	<b>B25-3110</b>

Chemicals	
Ultra PAG Oil 100 - 6pk, 8 oz Bottle	<b>MT3013</b>
Ultra PAG Oil 100 - 6pk, Quart Bottle	<b>MT3019</b>
Ultra PAG Oil 100 - Drum (52 gal)	<b>A10-6164</b>

Clutch Components	
Clutch Coil - OD/ID: 96mm / 64mm	<b>H25-7368</b>
Clutch Pulley - 2 Groove w/ Bearing (132mm)	<b>H25-7734</b>

Fasteners	
Bolt - Shipping Plate	<b>F25-2100</b>
Shaft Key	<b>F25-5110</b>
Retaining Ring - Coil (1.98mm)	<b>F10-4120</b>
Retaining Ring - Pulley	<b>F10-4130</b>
Retaining Ring (Beveled) - Shaft Seal Seat	<b>F25-4110</b>
Shim (Notched) - Clutch (0.13mm)	<b>F25-3101</b>
Shim (Notched) - Clutch (0.51mm)	<b>F25-3105</b>
Shim (Notched) - Clutch (0.81mm)	<b>F25-3104</b>
Shim (Notched) - Clutch (1.02mm)	<b>F25-3110</b>

Gaskets	
Gasket - Head	Fiber <b>G25-1151</b>
Gasket - Cylinder	Metal <b>G25-2152</b>
Gasket - Head	Metal <b>G25-2151</b>

Gaskets	
Gasket Kit	Metal <b>K25-2117</b>



Includes: Head Gasket (Metal) (1), Cylinder Gasket (Metal) (1)

Gasket Kit (Metal)	Green HNBR <b>K25-2110</b>
--------------------	----------------------------

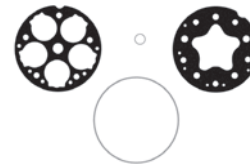

Includes: Head Gasket (Metal) (1), Cylinder Gasket (1), Case Lathe Cut Seal (1), Oil Plug O-Ring / Service Port O-Ring (Universal) (1)

Gasket Kit (Metal)	Black Nitrile <b>K25-2010</b>
--------------------	-------------------------------

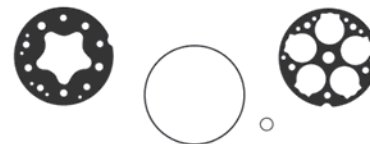

Includes: Head Gasket (Metal) (1), Cylinder Gasket (1), Case Lathe Cut Seal (1), Oil Plug O-Ring / Service Port O-Ring (Universal) (1)

Piston Components	
Centering Ball (22.23mm)	<b>P25-1875</b>

Reeds and Valve Plates	
Reed - Discharge Valve	<b>R25-2110</b>
Reed - Suction Valve	<b>R25-1110</b>

Service Items	
Fitting (Refrigerant) - Flare to Tube Adapter - #10	<b>A10-5104</b>
Fitting (Refrigerant) - Flare to Tube Adapter - #8	<b>A10-5103</b>
Fitting (Refrigerant) - 1/8-28 UNF w/Valve/O-Ring	<b>A10-1025</b>

## SANDEN

SD507, SD507A2, SD508, SD510

### Shaft Seals

Carbon Shaft Seal	HNBR <b>S13-2101</b>
Felt Ring (SD507/507A2)	<b>S25-4101</b>
Felt Ring (SD508/510)	<b>S25-4102</b>
Metal Shaft Seal Seat	<b>S25-3101</b>
Carbon Shaft Seal Kit	Green HNBR <b>K25-3105</b>



*Includes: Carbon Shaft Seal (1), Metal Shaft Seal Seat (1), Shaft Seal Seat O-Ring (1), Metal Shaft Seal Seat Retaining Ring (1)*

### Shipping Closures

Discharge Cap w/ Disc - 1" Height	<b>C25-1113</b>
Discharge Cap w/ Disc - 7/9" (.701") Height	<b>C25-1111</b>
Suction Cap w/ O-Ring - 4/5" (.800") Height	<b>C25-1112</b>
Suction Cap w/ O-Ring - 5/8" (.625") Height	<b>C25-1110</b>

### Tools

Clutch Puller (3 Screw)	<b>T25-1000</b>
Shaft Seal Installer / Remover	<b>T25-1030</b>
Shaft Seal Protector	<b>T25-1037</b>
Shaft Seal Protector, Adjustable	<b>T95-1227</b>





## SANDEN

### SD5H09, SD5H11, SD5H13

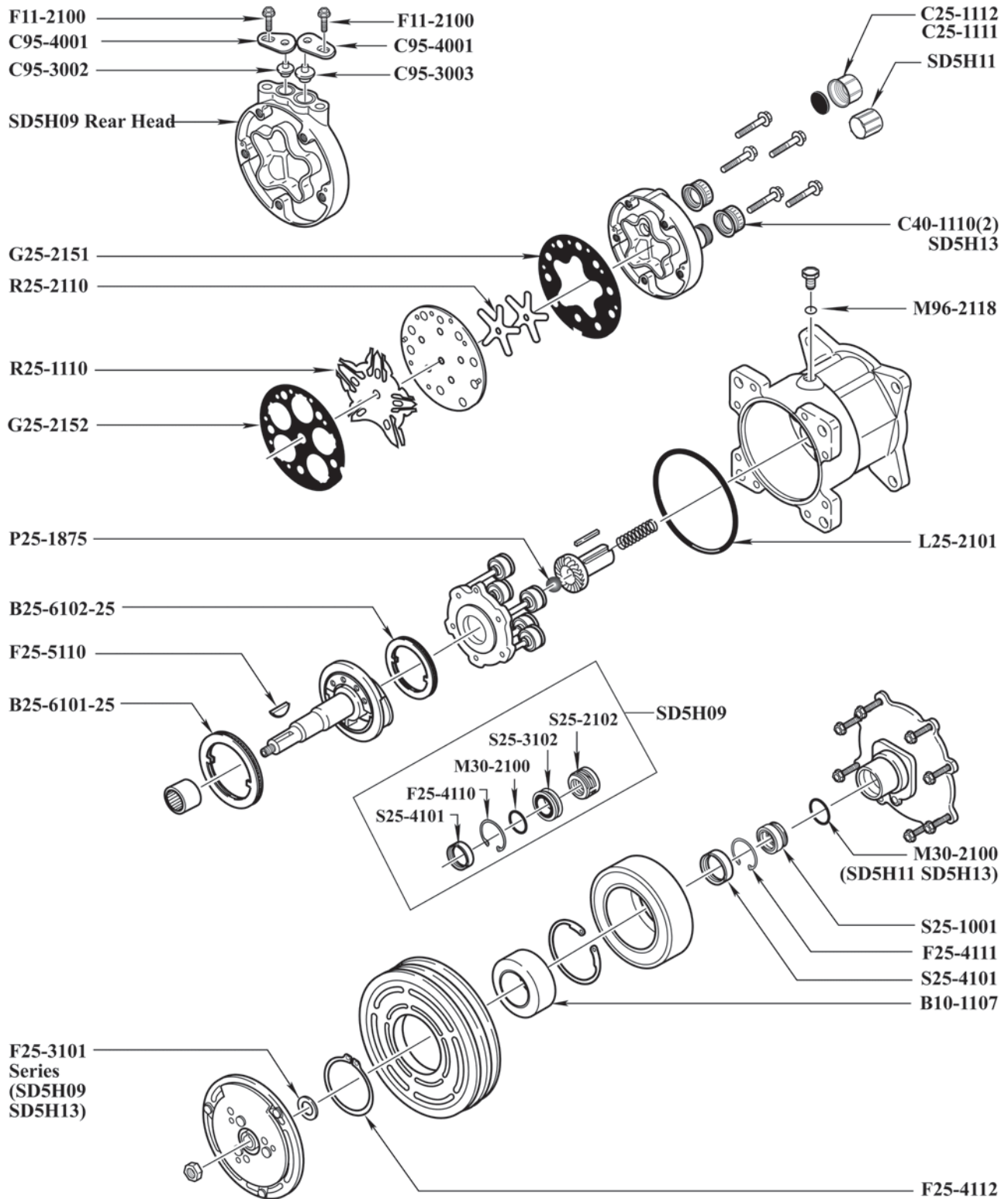

## SANDEN

SD5H09, SD5H11, SD5H13

O-Rings and Lathe Cuts	R134a and R-12 Compatible	Green HNBR	Black Nitrile
Case Lathe Cut Seal		<b>L25-2101</b>	<b>L25-1001</b>
Lip Seal O-Ring		<b>M30-2100</b>	<b>M30-1000</b>
Oil Drain Plug / Service Port O-Ring		<b>M96-2118</b>	<b>M96-1018</b>

Bearings	
Clutch Bearing (35mm x 55mm x 20mm)	<b>B10-1107</b>
Bearing Pack (Front)	<b>B25-6101-25</b>
Bearing Pack (Rear)	<b>B25-6102-25</b>

Chemicals	
Ultra PAG Oil 100 - 6pk, 8 oz Bottle	<b>MT3013</b>
Ultra PAG Oil 100 - 6pk, Quart Bottle	<b>MT3019</b>
Ultra PAG Oil 100 - Drum (52 gal)	<b>A10-6164</b>

Fasteners	
Bolt - Shipping Plate	<b>F11-2100</b>
Helical Insert - Rear Head / Shipping Plate (8-1.25 x 12mm)	<b>F10-6211</b>
Shaft Key	<b>F25-5110</b>
Retaining Ring - Pulley	<b>F25-4112</b>
Retaining Ring - Shaft Seal Seat	<b>F25-4111</b>
Retaining Ring (Beveled) - Lip Seal	<b>F25-4110</b>
Shim (Notched) - Clutch (0.13mm)	<b>F25-3101</b>
Shim (Notched) - Clutch (0.51mm)	<b>F25-3105</b>
Shim (Notched) - Clutch (0.81mm)	<b>F25-3104</b>
Shim (Notched) - Clutch (1.02mm)	<b>F25-3110</b>

Gaskets	
Gasket - Head	Fiber <b>G25-1151</b>
Gasket - Cylinder	Metal <b>G25-2152</b>
Gasket - Head	Metal <b>G25-2151</b>
Gasket Kit	Metal <b>K25-2117</b>



Includes: Head Gasket (Metal) (1), Cylinder Gasket (Metal) (1)

Gasket Kit (Metal) Green HNBR **K25-2110**



Includes: Head Gasket (Metal) (1), Cylinder Gasket (1), Case Lathe Cut Seal (1), Oil Plug O-Ring / Service Port O-Ring (Universal) (1)

Gaskets	
Gasket Kit (Metal)	Black Nitrile <b>K25-2010</b>

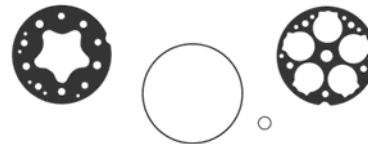

Includes: Head Gasket (Metal) (1), Cylinder Gasket (1), Case Lathe Cut Seal (1), Oil Plug O-Ring / Service Port O-Ring (Universal) (1)

Piston Components	
Centering Ball (22.23mm)	<b>P25-1875</b>

Reeds and Valve Plates	
Reed - Discharge Valve	<b>R25-2110</b>
Reed - Suction Valve	<b>R25-1110</b>

Service Items	
Fitting (Refrigerant) - Flare to Tube Adapter - #10	<b>A10-5104</b>
Fitting (Refrigerant) - Flare to Tube Adapter - #8	<b>A10-5103</b>

Shaft Seals	
Carbon Shaft Seal	HNBR <b>S25-2102</b>
Felt Ring	<b>S25-4102</b>
Lip Seal	HNBR <b>S25-1001</b>
Lip Seal (Black Rubber Coated)	HNBR <b>S30-1110</b>
Metal Shaft Seal Seat	<b>S25-3102</b>
Lip Seal Kit	Black Nitrile <b>K25-3156</b>



Includes: Lip Seal (1), Lip Seal Felt Ring (1), Lip Seal Retaining Ring (1)

## SANDEN

SD5H09, SD5H11, SD5H13

### Shaft Seals

Lip Seal Kit

Green HNBR **K30-1110**



*Includes: Lip Seal Retaining Ring (1), Lip Seal Metal Spacer (1), Lip Seal (1)*

### Shipping Closures

Discharge Cap w/ Disc - 7/9" (.701") Height **C25-1111**

Shipping Cap (SD5H13) **C40-1110**

Suction Cap w/ O-Ring - 4/5" (.800") Height **C25-1112**

Shipping Plate (Use with C95-3002 & C95-3003) **C95-4001**

Shipping Plug (Discharge) (Use with C95-4001) **C95-3002**

Shipping Plug (Suction) (Use with C95-4001) **C95-3003**

### Tools

Clutch Puller (3 Screw) **T25-1000**

Helical Insert Drill for 8-1.25mm Inserts **T10-6053**

Helical Insert Tap 8-1.25mm **T10-6254**

Helical Insert Tool 8-1.25mm - Bolt Style **T10-6554**

Shaft Seal Protector **T25-1037**

Shaft Seal Protector, Adjustable **T95-1227**

Helical Insert Repair Kit (8-1.25mm) **K10-1180**



*Includes: Helical Inserts (25), Drill (1), Tap (1), Installation Tool - Bolt Style (1)*



## SANDEN

### SD6V12

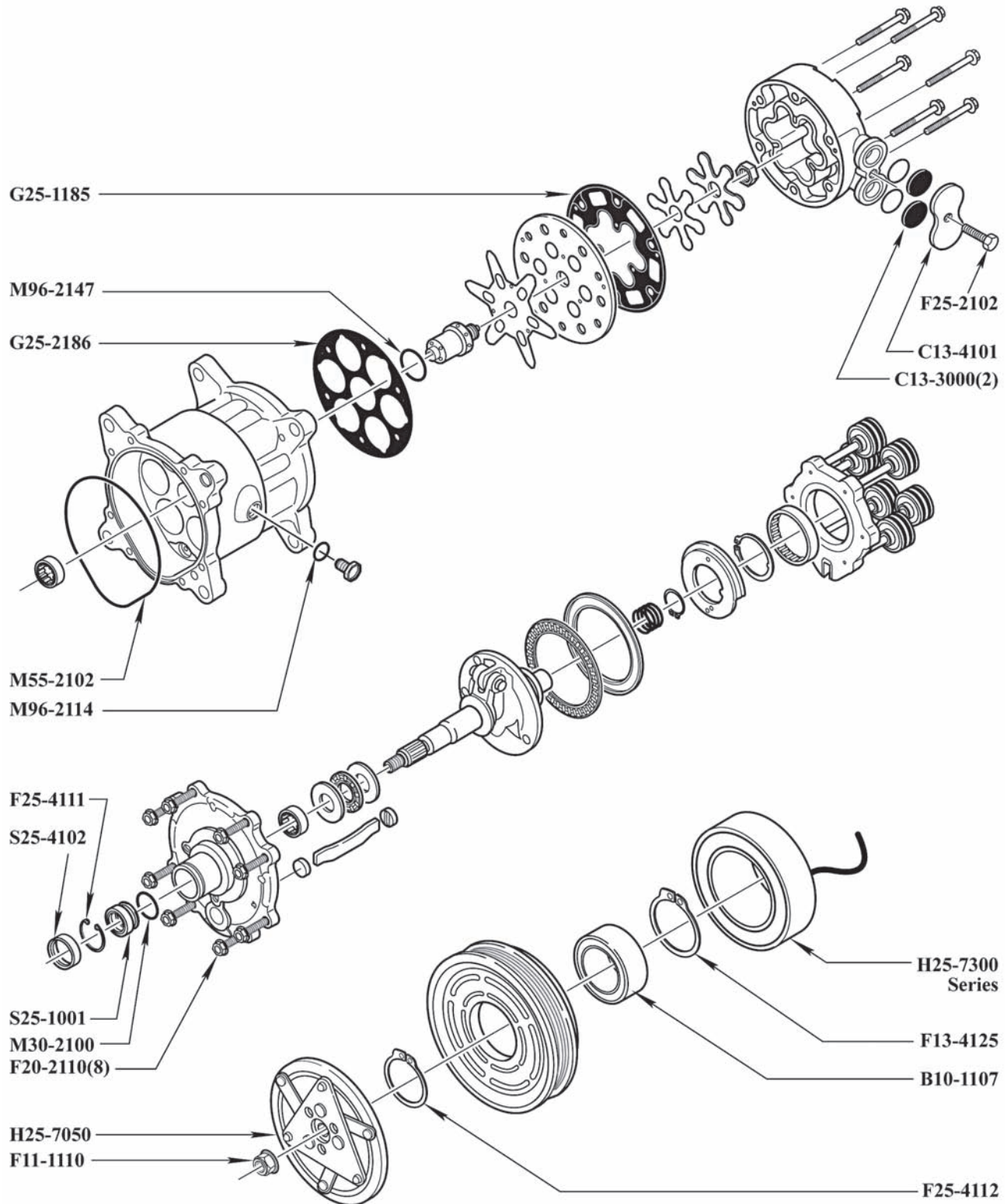

## SANDEN

### SD6V12

O-Rings	R134a and R-12 Compatible	Green HNBR	Black Nitrile
Case O-Ring		<b>M55-2102</b>	
Control Valve O-Ring		<b>M96-2147</b>	
Lip Seal O-Ring		<b>M30-2100</b>	<b>M30-1000</b>
Oil Drain Plug O-Ring		<b>M96-2114</b>	
<b>Bearings</b>			
Clutch Bearing (35mm x 55mm x 20mm)	<b>B10-1107</b>		
<b>Chemicals</b>			
Ultra PAG Oil 100 - 6pk, 8 oz Bottle	<b>MT3013</b>		
Ultra PAG Oil 100 - 6pk, Quart Bottle	<b>MT3019</b>		
Ultra PAG Oil 100 - Drum (52 gal)	<b>A10-6164</b>		
<b>Clutch Components</b>			
Clutch Coil - OD/ID: 86.2mm / 59mm (1410)	<b>H25-7311</b>		
Clutch Coil - OD/ID: 86mm / 59mm	<b>H25-7310</b>		
Clutch Coil - OD/ID: 86mm / 59mm	<b>H25-7366</b>		
Clutch Hub - OD: 105 mm	<b>H25-7050</b>		
<b>Control Valves</b>			
Control Valve (R134a)	<b>A25-5003</b>		
<b>Fasteners</b>			
Bolt - Front Head	<b>F20-2110</b>		
Bolt - Shipping Plate	<b>F25-2102</b>		
Nut - Shaft	<b>F11-1110</b>		
Retaining Ring - Clutch Coil (Beveled)	<b>F13-4125</b>		
Retaining Ring - Clutch Pulley	<b>F25-4112</b>		
Retaining Ring - Lip Seal	<b>F25-4111</b>		
<b>Gaskets</b>			
Gasket - Cylinder	Fiber <b>G25-1166</b>		
Gasket - Rear Head	Fiber <b>G25-1165</b>		
Gasket - Cylinder	Metal <b>G25-2186</b>		
Gasket - Rear Head	Metal <b>G25-2185</b>		
Gasket Kit (Fiber)	Green HNBR <b>K25-2140</b>		
<b>Gaskets</b>			
Gasket Kit (Metal)		Green HNBR <b>K25-2147</b>	
<b>Shaft Seals</b>			
Felt Ring		<b>S25-4102</b>	
Lip Seal		HNBR <b>S25-1001</b>	
Lip Seal Kit		Black Nitrile <b>K25-3156</b>	
<b>Shipping Closures</b>			
Shipping Pad (Use with C13-4101)		<b>C13-3000</b>	
Shipping Plate (Rounded) (Use with 2 C13-3000)		<b>C13-4101</b>	
<b>Tools</b>			
Shaft Seal Protector, Adjustable		<b>T95-1227</b>	



Includes: Cylinder Gasket (1), Head Gasket (1), Lip Seal O-Ring (1), Case O-Ring (1), Oil Drain Plug O-Ring (1), Control Valve O-Ring (1).

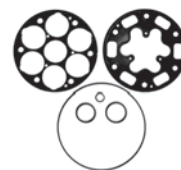

Includes: Cylinder Gasket (1), Head Gasket (1), Lip Seal O-Ring (1), Case O-Ring (1), Oil Drain Plug O-Ring (1), Control Valve O-Ring (1).



Includes: Lip Seal (1), Lip Seal Felt Ring (1), Lip Seal Retaining Ring (1).

## SANDEN

### SD708, SD709

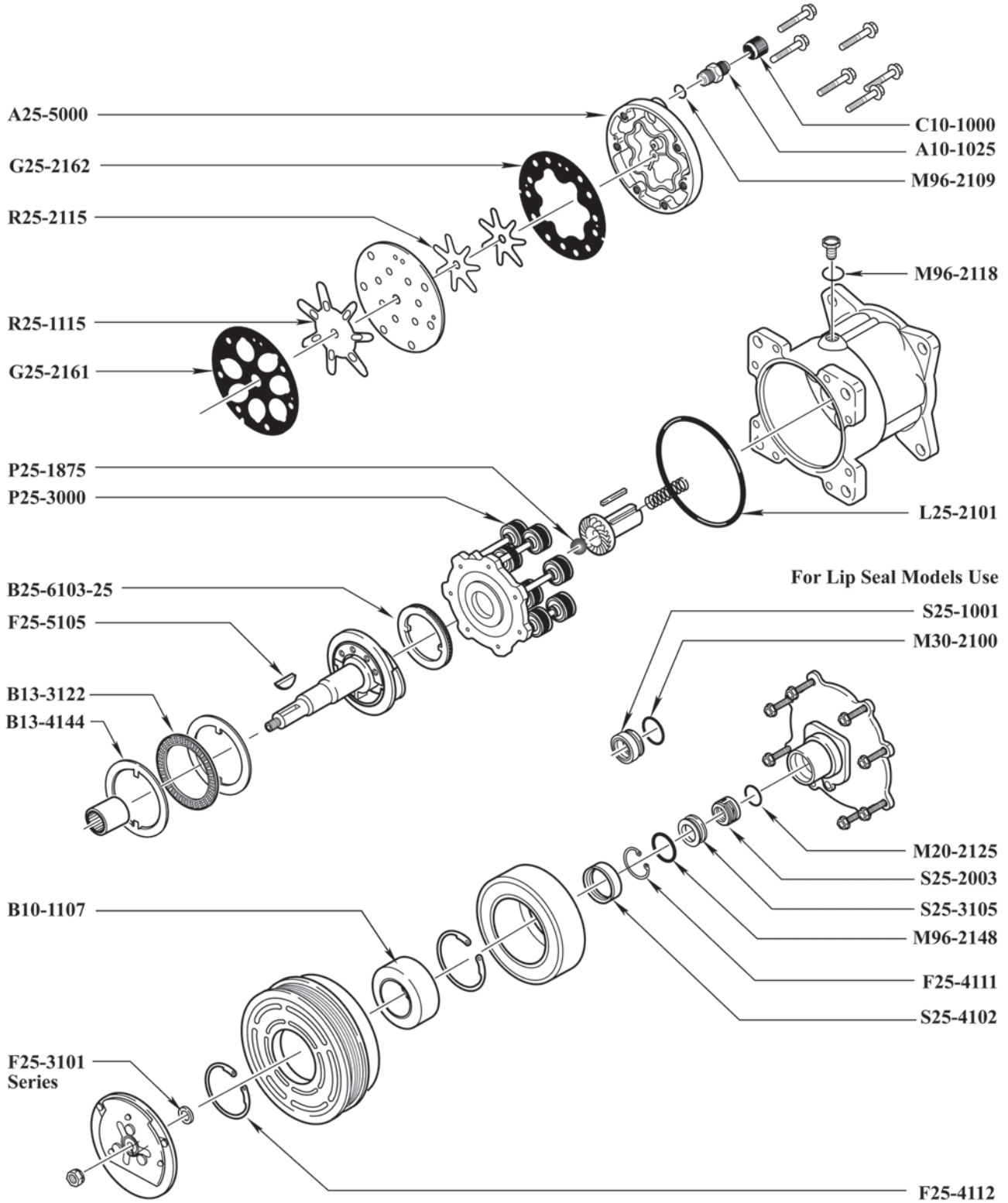



## SANDEN

### SD708, SD709

O-Rings and Lathe Cuts	R134a and R-12 Compatible	Green HNBR	Black Nitrile
Carbon Shaft Seal O-Ring		<b>M20-2125</b>	
Case Lathe Cut Seal		<b>L25-2101</b>	<b>L25-1001</b>
Lip Seal O-Ring		<b>M30-2100</b>	<b>M30-1000</b>
Oil Drain Plug O-Ring		<b>M96-2118</b>	<b>M96-1018</b>
Service Valve O-Ring		<b>M96-2109</b>	<b>M96-1009</b>
Shaft Seal Seat O-Ring		<b>M96-2148</b>	<b>M96-1048</b>

#### Bearings

Clutch Bearing (35mm x 55mm x 20mm)	<b>B10-1107</b>
Bearing Pack (Rear)	<b>B25-6103-25</b>
Thrust Bearing (75.2mm x 99.8mm x 4mm)	<b>B13-3122</b>
Thrust Race (Front - Inner Lip)(73.4mm x 99.8mm x 0.8mm)	<b>B13-4144</b>

#### Chemicals

Ultra PAG Oil 100 - 6pk, 8 oz Bottle	<b>MT3013</b>
Ultra PAG Oil 100 - 6pk, Quart Bottle	<b>MT3019</b>
Ultra PAG Oil 100 - Drum (52 gal)	<b>A10-6164</b>

#### Clutch Components

Clutch Coil - OD/ID: 96mm / 64mm	<b>H25-7353</b>
----------------------------------	-----------------

#### Electrical

Clutch Coil Assembly w/Diode	<b>E10-3000</b>
Clutch Coil Pigtail	<b>E11-4000</b>

#### Fasteners

Shaft Key	<b>F25-5105</b>
Retaining Ring - Clutch Pulley	<b>F25-4112</b>
Retaining Ring - Shaft Seal Seat	<b>F25-4111</b>
Shim (Notched) - Clutch (0.13mm)	<b>F25-3101</b>
Shim (Notched) - Clutch (0.51mm)	<b>F25-3105</b>
Shim (Notched) - Clutch (0.81mm)	<b>F25-3104</b>
Shim (Notched) - Clutch (1.02mm)	<b>F25-3110</b>

#### Gaskets

Gasket - Cylinder	Metal <b>G25-2161</b>
Gasket - Cylinder (Large Diameter)	Metal <b>G25-2166</b>
Gasket - Head	Metal <b>G25-2162</b>
Gasket Kit	Metal <b>K25-2116</b>



Includes: Head Gasket (Metal) (1), Cylinder Gasket (Metal) (1)

#### Gaskets

Gasket Kit (Metal) Green HNBR **K25-2115**

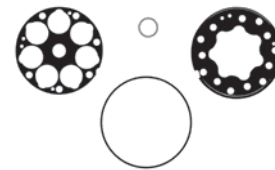

Includes: Case Lathe Cut Seal (1), Cylinder Gasket (Metal) (1), Head Gasket (Metal) (1), Oil Plug O-Ring (1)

Gasket Kit (Metal)(4.74 Dia) Green HNBR **K25-2113**

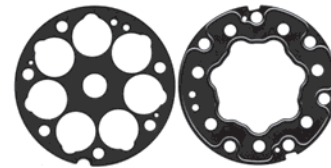

Includes: Cylinder Gasket (Metal) (1), Head Gasket (Metal) (1)

Gasket Kit (Metal)(4.74 Dia) Green HNBR **K25-2114**

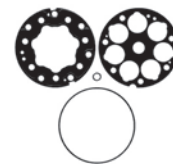

Includes: Cylinder Gasket (Metal) (1), Head Gasket (Metal) (1), Case O-Ring(1), PRV O-Ring(1)

Gasket Kit (Metal) Black Nitrile **K25-2015**



Includes: Case Lathe Cut Seal (1), Cylinder Gasket (Metal) (1), Head Gasket (Metal) (1), Oil Plug O-Ring (1)

#### Hard Components

Housing (Head) - Rear (SD708)	<b>H25-2002</b>
Rear Head - VW (709 SH Series)	<b>A25-5000</b>

## SANDEN

### SD708, SD709

#### Piston Components

Centering Ball (22.23mm)	<b>P25-1875</b>
Piston Ring - Standard	<b>P25-3000</b>

#### Reeds and Valve Plates

Reed - Discharge Valve	<b>R25-2115</b>
Reed - Suction Valve	<b>R25-1115</b>

#### Service Items

Fitting (Refrigerant) - 1/8-28 UNF w/Valve/O-Ring	<b>A10-1025</b>
---	-----------------

#### Shaft Seals

Carbon Shaft Seal	Nitrile <b>S25-2003</b>
Felt Ring	<b>S25-4102</b>
Lip Seal	HNBR <b>S25-1001</b>
Metal Shaft Seal Seat	<b>S25-3105</b>
Carbon Shaft Seal Kit	Black Nitrile <b>K25-3017</b>



*Includes: Carbon Shaft Seal (1), Metal Shaft Seal Seat (1), Metal Felt Ring (1), Metal Shaft Seal Seat O-Ring (1)*

#### Lip Seal Kit

Black Nitrile **K25-3156**



*Includes: Lip Seal (1), Lip Seal Felt Ring (1), Lip Seal Retaining Ring (1)*

#### Shipping Closures

Cap - # 8 Male Threaded Suction (SD709)	<b>C25-1116</b>
Cap - #10 Male Threaded Suction (SD709)	<b>C25-1115</b>
Cap - 1/4" Low Side	<b>C10-1000</b>
Discharge Cap w/ Disc - 1" Height	<b>C25-1113</b>
Discharge Cap w/ Disc - 7/9" (.701") Height	<b>C25-1111</b>
Shipping Cap	<b>C40-1110</b>
Suction Cap w/ O-Ring - 4/5" (.800") Height	<b>C25-1112</b>
Suction Cap w/ O-Ring - 5/8" (.625") Height	<b>C25-1110</b>

#### Tools

Clutch Puller (3 Screw)	<b>T25-1000</b>
Piston Ring Expansion Cone (Requires T13-3010)	<b>T25-3004</b>
Piston Ring Installer	<b>T13-3010</b>

#### Tools

Shaft Seal Install / Remover	<b>T25-3001</b>
Shaft Seal Protector	<b>T25-1037</b>
Shaft Seal Protector, Adjustable	<b>T95-1227</b>



## SANDEN

### SD709CA

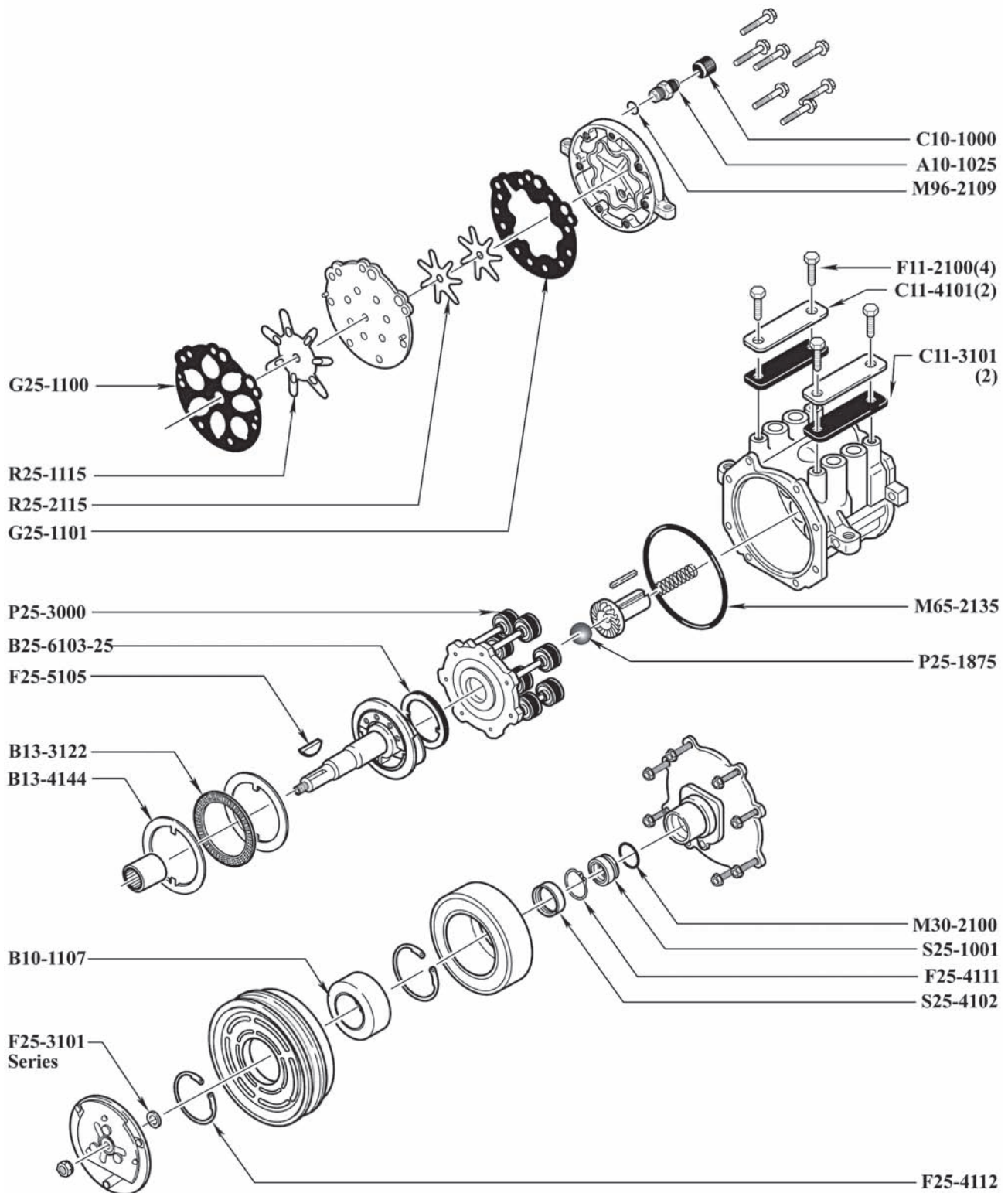

## SANDEN

### SD709CA

O-Rings	R134a and R-12 Compatible	Green HNBR	Black Nitrile
Case O-Ring		<b>M65-2135</b>	<b>M65-1035</b>
Lip Seal O-Ring		<b>M30-2100</b>	<b>M30-1000</b>
Service Valve O-Ring		<b>M96-2109</b>	<b>M96-1009</b>

Bearings	
Clutch Bearing (35mm x 55mm x 20mm)	<b>B10-1107</b>
Bearing Pack (Rear)	<b>B25-6103-25</b>
Thrust Bearing (75.2mm x 99.8mm x 4mm)	<b>B13-3122</b>
Thrust Race (Front - Inner Lip)(73.4mm x 99.8mm x 0.8mm)	<b>B13-4144</b>

Chemicals	
Ultra PAG Oil 100 - 6pk, 8 oz Bottle	<b>MT3013</b>
Ultra PAG Oil 100 - 6pk, Quart Bottle	<b>MT3019</b>
Ultra PAG Oil 100 - Drum (52 gal)	<b>A10-6164</b>

Fasteners	
Bolt - Shipping Plate	<b>F11-2100</b>
Helical Insert - Rear Head / Shipping Plate (8-1.25 x 12mm)	<b>F10-6211</b>
Shaft Key	<b>F25-5105</b>
Retaining Ring - Clutch Pulley	<b>F25-4112</b>
Retaining Ring - Lip Seal	<b>F25-4111</b>
Shim (Notched) - Clutch (0.13mm)	<b>F25-3101</b>
Shim (Notched) - Clutch (0.51mm)	<b>F25-3105</b>
Shim (Notched) - Clutch (0.81mm)	<b>F25-3104</b>
Shim (Notched) - Clutch (1.02mm)	<b>F25-3110</b>

Gaskets	
Gasket - Cylinder	Fiber <b>G25-1100</b>
Gasket - Head	Fiber <b>G25-1101</b>
Gasket Kit (Fiber)	Green HNBR <b>K25-2120</b>

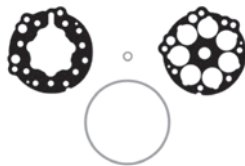

Includes: Cylinder Gasket (Fiber) (1), Head Gasket (Fiber) (1), Case O-Ring (1), Valve Core O-Ring (1)

Piston Components	
Centering Ball (22.23mm)	<b>P25-1875</b>
Piston Ring - Standard	<b>P25-3000</b>

Reeds and Valve Plates	
Reed - Discharge Valve	<b>R25-2115</b>
Reed - Suction Valve	<b>R25-1115</b>

Service Items	
Fitting (Refrigerant) - 1/8-28 UNF w/Valve/O-Ring	<b>A10-1025</b>

Shaft Seals	
Felt Ring	<b>S25-4102</b>
Lip Seal	HNBR <b>S25-1001</b>
Lip Seal Kit	Black Nitrile <b>K25-3156</b>



Includes: Lip Seal (1), Lip Seal Felt Ring (1), Lip Seal Retaining Ring (1)

Shipping Closures	
Cap - 1/4" Low Side	<b>C10-1000</b>
Shipping Pad (Use with C11-4101)	<b>C11-3101</b>
Shipping Plate (Use with 2 C11-3101)	<b>C11-4101</b>
Shipping Plate (Use with C95-3004)	<b>C95-4001</b>
Shipping Plug (Suction/Disch) (Use with C95-4001)	<b>C95-3004</b>

Tools	
Clutch Puller (3 Screw)	<b>T25-1000</b>
Helical Insert Drill for 8-1.25mm Inserts	<b>T10-6053</b>
Helical Insert Tap 8-1.25mm	<b>T10-6254</b>
Helical Insert Tool 8-1.25mm - Bolt Style	<b>T10-6554</b>
Piston Ring Expansion Cone (Requires T13-3010)	<b>T25-3004</b>
Piston Ring Installer	<b>T13-3010</b>
Shaft Seal Install / Remover	<b>T25-3001</b>
Shaft Seal Protector	<b>T25-1037</b>
Shaft Seal Protector, Adjustable	<b>T95-1227</b>

## SANDEN SD709CP

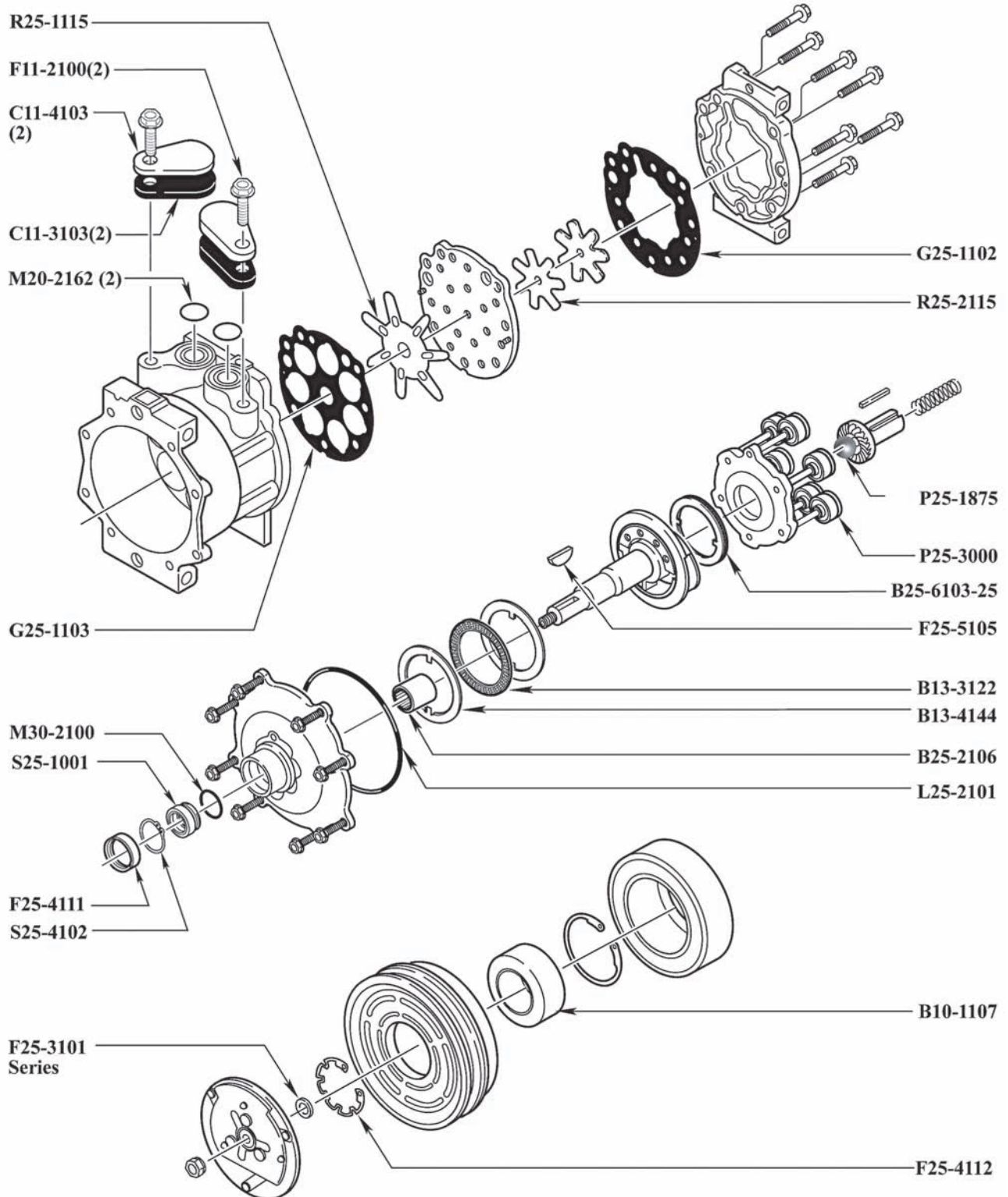

## SANDEN

### SD709CP

O-Rings and Lathe Cuts	R134a and R-12 Compatible	Green HNBR	Black Nitrile
Case Lathe Cut Seal		<b>L25-2101</b>	<b>L25-1001</b>
Lip Seal O-Ring		<b>M30-2100</b>	<b>M30-1000</b>
Suction / Discharge O-Ring		<b>M20-2162</b>	

#### Bearings

Clutch Bearing (35mm x 55mm x 20mm)	<b>B10-1107</b>
Bearing Pack (Rear)	<b>B25-6103-25</b>
Thrust Bearing (75.2mm x 99.8mm x 4mm)	<b>B13-3122</b>
Thrust Race (Front - Inner Lip)(73.4mm x 99.8mm x 0.8mm)	<b>B13-4144</b>

#### Chemicals

Ultra PAG Oil 100 - 6pk, 8 oz Bottle	<b>MT3013</b>
Ultra PAG Oil 100 - 6pk, Quart Bottle	<b>MT3019</b>
Ultra PAG Oil 100 - Drum (52 gal)	<b>A10-6164</b>

#### Fasteners

Bolt - Shipping Plate	<b>F11-2100</b>
Helical Insert - Rear Head / Shipping Plate (8-1.25 x 12mm)	<b>F10-6211</b>
Shaft Key	<b>F25-5105</b>
Retaining Ring - Clutch Pulley	<b>F25-4112</b>
Retaining Ring - Lip Seal	<b>F25-4111</b>
Shim (Notched) - Clutch (0.13mm)	<b>F25-3101</b>
Shim (Notched) - Clutch (0.51mm)	<b>F25-3105</b>
Shim (Notched) - Clutch (0.81mm)	<b>F25-3104</b>
Shim (Notched) - Clutch (1.02mm)	<b>F25-3110</b>

#### Gaskets

Gasket - Cylinder	Fiber <b>G25-1103</b>
Gasket - Head	Fiber <b>G25-1102</b>
Gasket Kit (Fiber)	Green HNBR <b>K25-2130</b>



Includes: Cylinder Gasket (Fiber) (1), Head Gasket (Fiber) (1), Case Lathe Cut (1)

#### Piston Components

Centering Ball (22.23mm)	<b>P25-1875</b>
Piston Ring - Standard	<b>P25-3000</b>

#### Reeds and Valve Plates

Reed - Discharge Valve	<b>R25-2115</b>
Reed - Suction Valve	<b>R25-1115</b>

#### Shaft Seals

Felt Ring	<b>S25-4102</b>
Lip Seal	HNBR <b>S25-1001</b>
Lip Seal Kit	Black Nitrile <b>K25-3156</b>



Includes: Lip Seal (1), Lip Seal Felt Ring (1), Lip Seal Retaining Ring (1)

#### Shipping Closures

Shipping Pad (Use with C11-4103)	<b>C11-3103</b>
Shipping Plate (Use with C11-3103)	<b>C11-4103</b>
Shipping Plate (Use with C95-3003)	<b>C95-4001</b>
Shipping Plug (Suction/Disch) (Use with C95-4001)	<b>C95-3003</b>

#### Tools

Clutch Puller (3 Screw)	<b>T25-1000</b>
Helical Insert Drill for 8-1.25mm Inserts	<b>T10-6053</b>
Helical Insert Tap 8-1.25mm	<b>T10-6254</b>
Helical Insert Tool 8-1.25mm - Bolt Style	<b>T10-6554</b>
Piston Ring Expansion Cone (Requires T13-3010)	<b>T25-3004</b>
Piston Ring Installer	<b>T13-3010</b>
Shaft Seal Install / Remover	<b>T25-3001</b>
Shaft Seal Protector	<b>T25-1037</b>
Shaft Seal Protector, Adjustable	<b>T95-1227</b>
Helical Insert Repair Kit (8-1.25mm)	<b>K10-1180</b>



Includes: Helical Inserts (25), Drill (1), Tap (1), Installation Tool - Bolt Style (1)

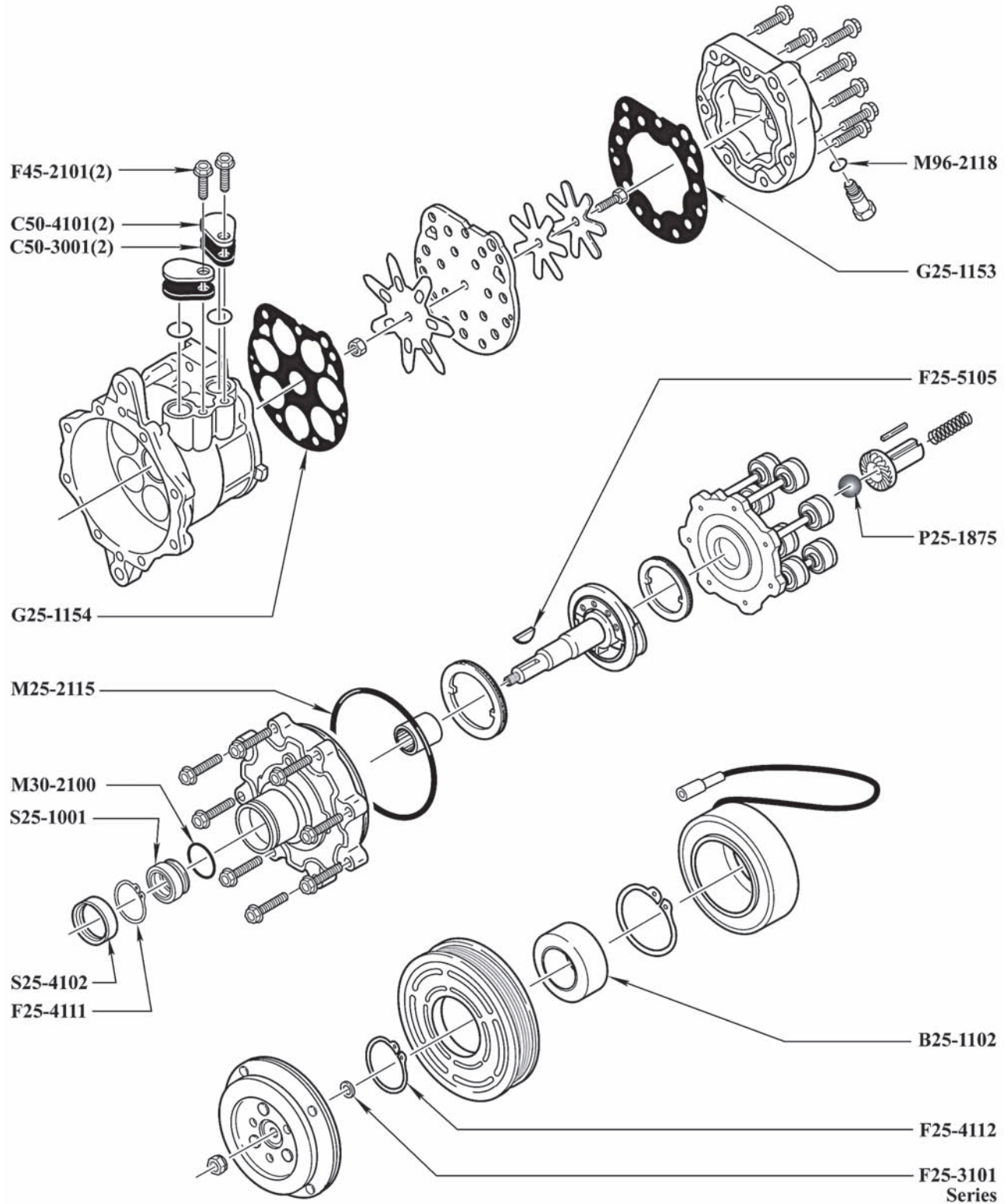

## SANDEN SD7B10





## SANDEN

### SD7B10

O-Rings	R134a and R-12 Compatible	Green HNBR	Black Nitrile
High Pressure Relief Valve O-Ring		<b>M96-2118</b>	<b>M96-1018</b>
Lip Seal O-Ring		<b>M30-2100</b>	<b>M30-1000</b>
Nose Piece O-Ring		<b>M25-2115</b>	
Bearings		Shaft Seals	
Clutch Bearing (35mm x 50mm x 20mm)	<b>B25-1102</b>	Lip Seal Kit	Black Nitrile <b>K25-3156</b>
Chemicals		 <p><i>Includes: Lip Seal (1), Lip Seal Felt Ring (1), Lip Seal Retaining Ring (1).</i></p>	
Ultra PAG Oil 100 - 6pk, 8 oz Bottle	<b>MT3013</b>		
Ultra PAG Oil 100 - 6pk, Quart Bottle	<b>MT3019</b>		
Ultra PAG Oil 100 - Drum (52 gal)	<b>A10-6164</b>		
Clutch Components		Shipping Closures	
Clutch Coil - OD/ID: 86.2mm / 59mm	<b>H25-7354</b>	Shipping Pad (Use with C50-4101)	<b>C50-3001</b>
Fasteners		Shipping Plate (Use with C50-3001)	<b>C50-4101</b>
Bolt - Shipping Plate	<b>F45-2101</b>	Shipping Plate (Use with C95-3003 & C95-3005)	<b>C95-4002</b>
Shaft Key	<b>F25-5105</b>	Shipping Plug (Discharge) (Use with C95-4002)	<b>C95-3003</b>
Retaining Ring - Clutch Pulley	<b>F25-4112</b>	Shipping Plug (Suction) (Use with C95-4002)	<b>C95-3005</b>
Retaining Ring - Lip Seal	<b>F25-4111</b>	Tools	
Shim (Notched) - Clutch (0.13mm)	<b>F25-3101</b>	Shaft Seal Protector	<b>T25-1037</b>
Shim (Notched) - Clutch (0.51mm)	<b>F25-3105</b>	Shaft Seal Protector, Adjustable	<b>T95-1227</b>
Shim (Notched) - Clutch (0.81mm)	<b>F25-3104</b>		
Shim (Notched) - Clutch (1.02mm)	<b>F25-3110</b>		
Gaskets			
Gasket - Cylinder	Fiber <b>G25-1154</b>		
Gasket - Head	Fiber <b>G25-1153</b>		
Gasket Kit (Fiber)	Green HNBR <b>K25-2125</b>		
			
<p><i>Includes: Head Gasket (1), Cylinder Gasket(1), Nose Piece O-Ring (1), Oil Drain Plug O-Ring (1)</i></p>			
Piston Components			
Centering Ball (22.23mm)	<b>P25-1875</b>		
Shaft Seals			
Felt Ring	<b>S25-4102</b>		
Lip Seal	HNBR <b>S25-1001</b>		

## SANDEN

### SD7C16

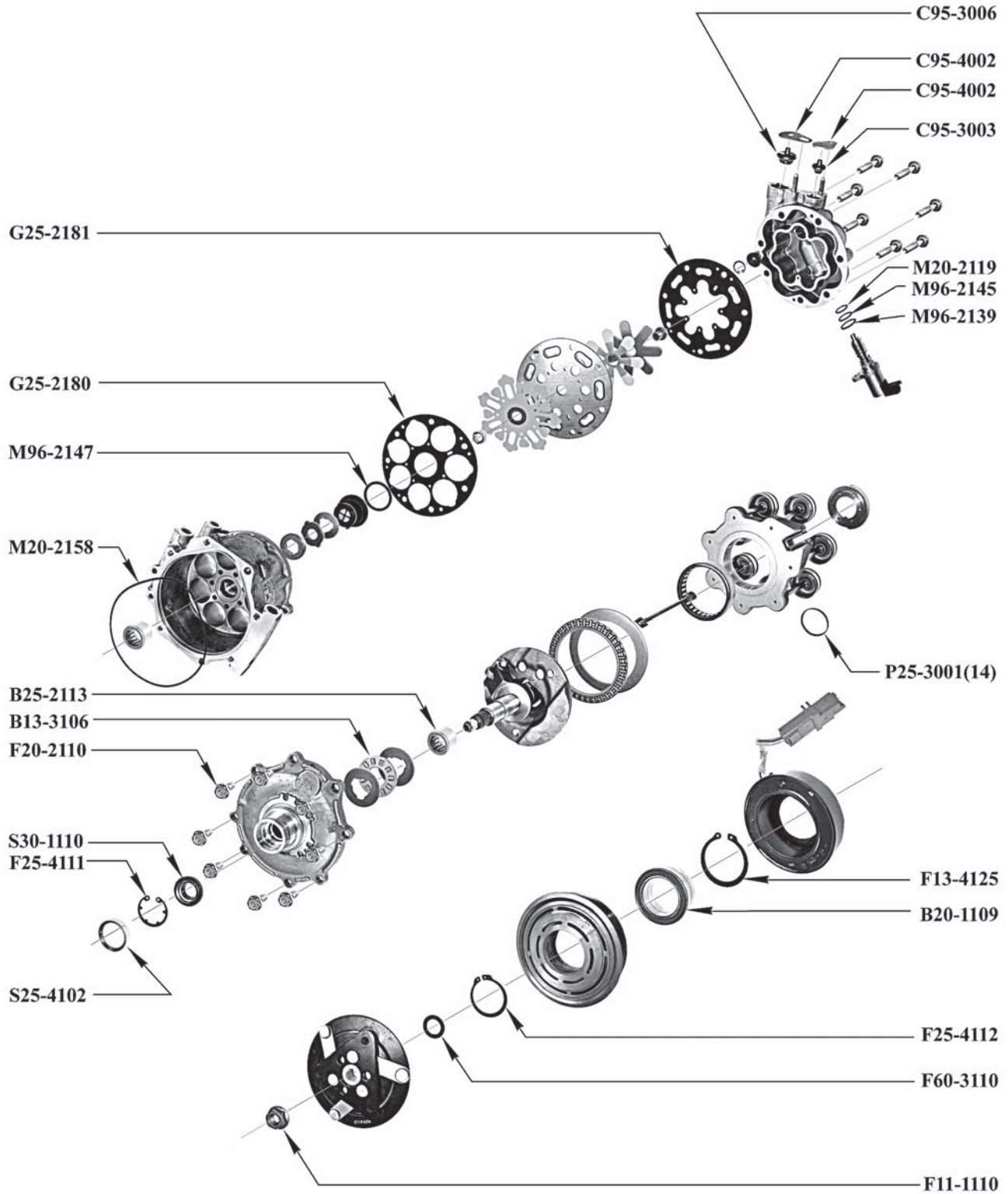

## SANDEN

### SD7C16

O-Rings	R134a and R-12 Compatible	Green HNBR	Black Nitrile
Case O-Ring		<b>M20-2158</b>	<b>M20-1058</b>
Control Valve Inner O-Ring		<b>M20-2119</b>	
Control Valve Middle O-Ring		<b>M96-2139</b>	
Control Valve Outer O-Ring		<b>M96-2145</b>	
Oil Drain Bolt O-Ring		<b>M20-2163</b>	
Screen O-Ring		<b>M96-2147</b>	

Bearings	
Case Bearing (16.3mm x 22mm x 16mm)	<b>B25-2113</b>
Clutch Bearing (35mm x 52mm x 20mm)	<b>B20-1109</b>
Thrust Bearing (16mm x 35mm x 4.8mm)	<b>B13-3106</b>

Chemicals	
Ultra PAG Oil 46 - 6pk, 8 oz Bottle	<b>MT3012</b>
Ultra PAG Oil 46 - 6pk, Quart Bottle	<b>MT3018</b>
Ultra PAG Oil 46 - Drum (52 gal)	<b>A10-6163</b>

Control Valves	
O-Ring Kit, Control Valve (3 O-Rings)	Green HNBR <b>K25-2144</b>



Fasteners	
Bolt - Head	<b>F20-2110</b>
Helical Insert - Rear Head / Shipping Plate (8-1.25 x 12mm)	<b>F10-6211</b>
Nut - Shaft	<b>F11-1110</b>
Retaining Ring - Clutch Coil (Beveled)	<b>F13-4125</b>
Retaining Ring - Clutch Pulley	<b>F25-4112</b>
Retaining Ring - Lip Seal	<b>F25-4111</b>
Shim - Clutch (0.13mm)	<b>F60-3110</b>

Gaskets	
Sanden SD7C16 Cylinder Gasket (Metal)	Metal <b>G25-2180</b>
Sanden SD7C16 Rear Head Gasket (Metal)	Metal <b>G25-2181</b>

Gaskets	
Gasket Kit (Metal)	Green HNBR <b>K25-2141</b>

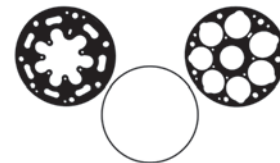

Includes: Cylinder Gasket (1), Head Gasket (1), Case O-Ring (1)

Piston Components	
Piston Ring - Standard	<b>P25-3001</b>

Shaft Seals	
Felt Ring	<b>S25-4102</b>
Lip Seal (Black Rubber Coated)	HNBR <b>S30-1110</b>
Lip Seal Kit	Green HNBR <b>K30-1110</b>



Includes: Lip Seal Retaining Ring (1), Lip Seal Metal Spacer (1), Lip Seal (1)

Shipping Closures	
Shipping Plate (Use with C95-3003 & C95-3006)	<b>C95-4002</b>
Shipping Plug (Discharge) (Use with C95-4002)	<b>C95-3003</b>
Shipping Plug (Suction) (Use with C95-4002)	<b>C95-3006</b>

Tools	
Helical Insert Drill for 8-1.25mm Inserts	<b>T10-6053</b>
Helical Insert Tap 8-1.25mm	<b>T10-6254</b>
Helical Insert Tool 8-1.25mm - Bolt Style	<b>T10-6554</b>
Shaft Seal Protector, Adjustable	<b>T95-1230</b>

## **SANDEN**

**SD7H13**

## SANDEN

### SD7H13

O-Rings and Lathe Cuts	R134a and R-12 Compatible	Green HNBR	Black Nitrile
Case Lathe Cut Seal (Early)		<b>L25-2101</b>	<b>L25-1001</b>
Lip Seal O-Ring		<b>M30-2100</b>	<b>M30-1000</b>
Oil Drain Plug / Service Port O-Ring		<b>M96-2118</b>	<b>M96-1018</b>

#### Chemicals

Ultra PAG Oil 100 - 6pk, 8 oz Bottle	<b>MT3013</b>
Ultra PAG Oil 100 - 6pk, Quart Bottle	<b>MT3019</b>
Ultra PAG Oil 100 - Drum (52 gal)	<b>A10-6164</b>

#### Tools

Piston Ring Installer	<b>T13-3010</b>
Shaft Seal Protector	<b>T25-1037</b>
Shaft Seal Protector, Adjustable	<b>T95-1227</b>

#### Fasteners

Retaining Ring - Lip Seal	<b>F25-4111</b>
---------------------------	-----------------

#### Gaskets

Gasket - Cylinder (Large Diameter)	Metal <b>G25-2166</b>
Gasket - Head	Metal <b>G25-2162</b>
Gasket Kit (Metal)(4.74 Dia)	Green HNBR <b>K25-2113</b>



Includes: Cylinder Gasket (Metal) (1), Head Gasket (Metal) (1)

Gasket Kit (Metal)(4.74 Dia)	Green HNBR <b>K25-2114</b>
------------------------------	----------------------------

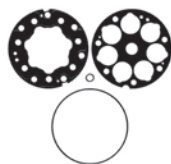

Includes: Cylinder Gasket (Metal) (1), Head Gasket (Metal) (1), Case O-Ring(1), PRV O-Ring(1)

#### Shaft Seals

Felt Ring	<b>S25-4102</b>
Lip Seal	HNBR <b>S25-1001</b>
Lip Seal Kit	Black Nitrile <b>K25-3156</b>



Includes: Lip Seal (1), Lip Seal Felt Ring (1), Lip Seal Retaining Ring (1).

#### Tools

Piston Ring Expansion Cone (Requires T13-3010)	<b>T25-3004</b>
--	-----------------

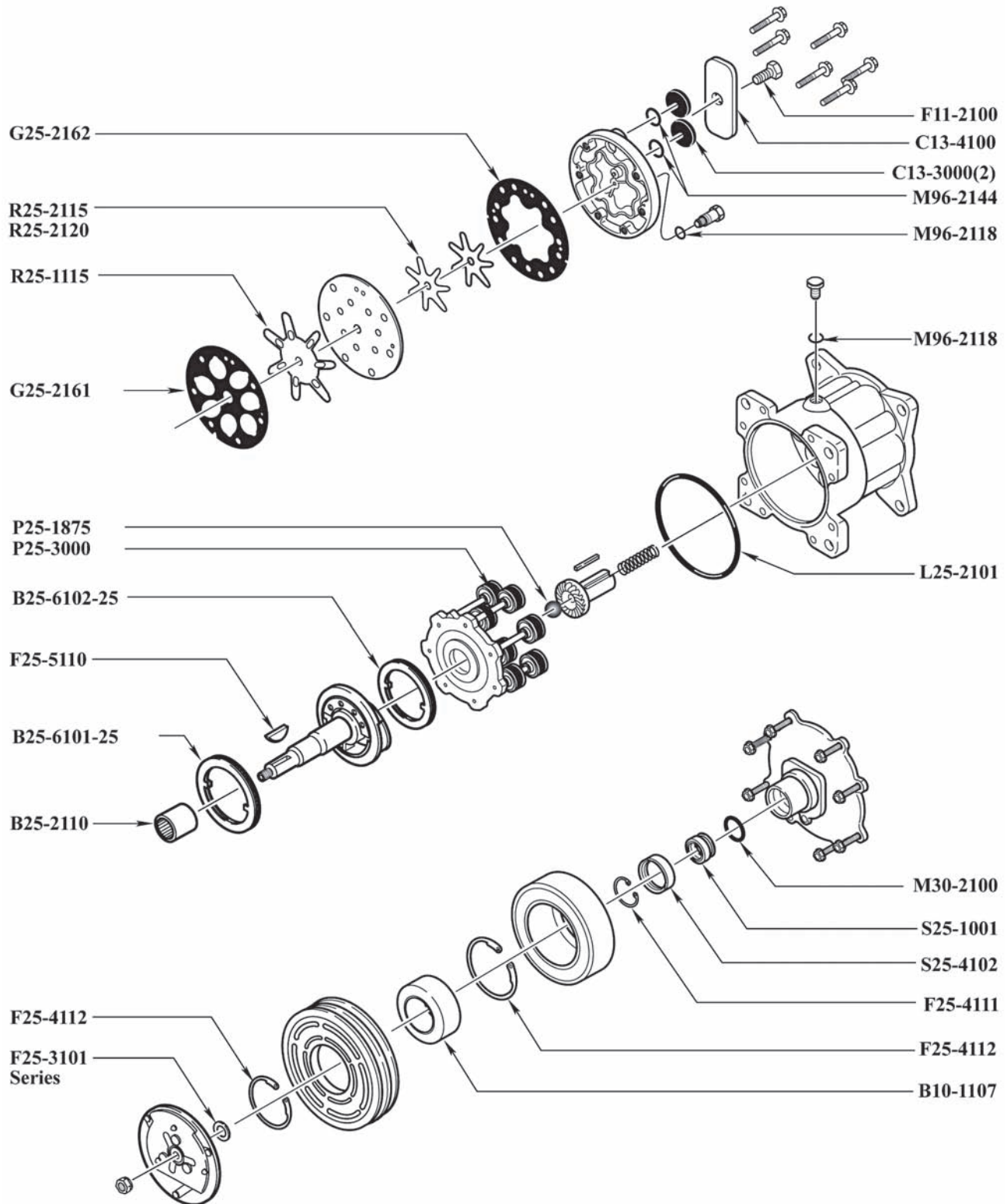

## SANDEN

### SD7H15

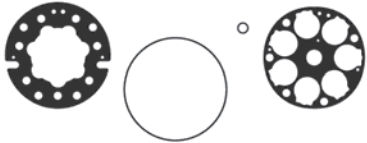

## SANDEN

### SD7H15

O-Rings and Lathe Cuts	R134a and R-12 Compatible	Green HNBR	Black Nitrile
Case Lathe Cut Seal		<b>L25-2101</b>	<b>L25-1001</b>
Lip Seal O-Ring		<b>M30-2100</b>	<b>M30-1000</b>
Oil Drain Plug / Service Port O-Ring		<b>M96-2118</b>	<b>M96-1018</b>
Suction / Discharge Port O-Ring		<b>M96-2144</b>	<b>M96-1044</b>
<b>Bearings</b>			
Case Bearing (20mm x 27.1mm x 30mm)	<b>B25-2110</b>		
Clutch Bearing (35mm x 55mm x 20mm)	<b>B10-1107</b>		
Bearing Pack (Front)	<b>B25-6101-25</b>		
Bearing Pack (Rear)	<b>B25-6102-25</b>		
<b>Chemicals</b>			
Ultra PAG Oil 100 - 6pk, 8 oz Bottle	<b>MT3013</b>		
Ultra PAG Oil 100 - 6pk, Quart Bottle	<b>MT3019</b>		
Ultra PAG Oil 100 - Drum (52 gal)	<b>A10-6164</b>		
<b>Clutch Components</b>			
Clutch Assembly (Dodge Dakota & Durango)	<b>H25-7900</b>		
Clutch Coil - OD/ID: 96mm / 64mm	<b>H25-7340</b>		
Clutch Coil - OD/ID: 96mm / 64mm	<b>H25-7357</b>		
Clutch Coil - OD/ID: 96mm / 64mm	<b>H25-7362</b>		
Clutch Coil w/ Diode - OD/ID: 102.91mm / 64mm	<b>H25-7387</b>		
Clutch Hub (23 Spline) - OD: 105mm	<b>H25-7060</b>		
Clutch Hub (Keyed) - OD: 105mm	<b>H25-7061</b>		
Clutch Pulley - 7 Groove w/Bearing (133mm)	<b>H25-7705</b>		
<b>Fasteners</b>			
Bolt - Shipping Plate	<b>F11-2100</b>		
Helical Insert - Rear Head / Shipping Plate (8-1.25 x 12mm)	<b>F10-6211</b>		
Shaft Key	<b>F25-5110</b>		
Retaining Ring - Clutch Pulley	<b>F25-4112</b>		
Retaining Ring - Lip Seal	<b>F25-4111</b>		
Shim (Notched) - Clutch (0.13mm)	<b>F25-3101</b>		
Shim (Notched) - Clutch (0.51mm)	<b>F25-3105</b>		
Shim (Notched) - Clutch (0.81mm)	<b>F25-3104</b>		
Shim (Notched) - Clutch (1.02mm)	<b>F25-3110</b>		
<b>Gaskets</b>			
Gasket - Cylinder - Rover/Jaguar	Fiber <b>G25-1110</b>		
Gasket - Cylinder	Metal <b>G25-2161</b>		
Gasket - Cylinder - Rover/Jaguar	Metal <b>G25-2110</b>		
Gasket - Cylinder (Large Diameter)	Metal <b>G25-2166</b>		
Gasket - Head	Metal <b>G25-2162</b>		
<b>Gaskets</b>			
Gasket Kit			Metal <b>K25-2116</b>
			
<i>Includes: Head Gasket (Metal) (1), Cylinder Gasket (Metal) (1)</i>			
Gasket Kit (Fiber)		Green HNBR <b>K25-2118</b>	
(Rover/Jaguar)			
			
<i>Includes: Head Gasket (Metal) (1), Cylinder Gasket (Metal) (1), Case Lathe Cut Seal (1), Service Port O-Ring (1)</i>			
Gasket Kit (Metal)		Green HNBR <b>K25-2115</b>	
			
<i>Includes: Case Lathe Cut Seal (1), Cylinder Gasket (Metal) (1), Head Gasket (Metal) (1), Oil Plug O-Ring (1)</i>			
Gasket Kit (Metal)(4.74 Dia)		Green HNBR <b>K25-2113</b>	
			
<i>Includes: Cylinder Gasket (Metal) (1), Head Gasket (Metal) (1)</i>			

## SANDEN

### SD7H15

#### Gaskets

Gasket Kit (Metal)(4.74 Dia) Green HNBR **K25-2114**

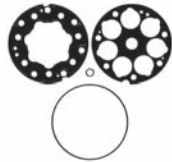

*Includes: Cylinder Gasket (Metal) (1), Head Gasket (Metal) (1), Case O-Ring(1), PRV O-Ring(1)*

Gasket Kit (Metal)

Black Nitrile **K25-2015**

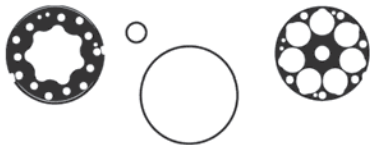

*Includes: Case Lathe Cut Seal (1), Cylinder Gasket (Metal) (1), Head Gasket (Metal) (1), Oil Plug O-Ring (1)*

#### Piston Components

Centering Ball (22.23mm) **P25-1875**

Piston Ring - Standard **P25-3000**

#### Reeds and Valve Plates

Reed - Discharge Valve **R25-2115**

Reed - Discharge Valve (New Style) **R25-2120**

Reed - Suction Valve **R25-1115**

#### Shaft Seals

Felt Ring **S25-4102**

Lip Seal (Black Rubber Coated) HNBR **S30-1110**

Lip Seal (Metal Can) HNBR **S25-1001**

Lip Seal Kit Black Nitrile **K25-3156**



*Includes: Lip Seal (1), Lip Seal Felt Ring (1), Lip Seal Retaining Ring (1).*

#### Shaft Seals

Lip Seal Kit Green HNBR **K30-1110**



*Includes: Lip Seal Retaining Ring (1), Lip Seal Metal Spacer (1), Lip Seal (1)*

#### Shipping Closures

Shipping Pad (Use with C13-4100 or C13-4101) **C13-3000**

Shipping Plate (Rectangular) (Use with 2 C13-3000) **C13-4100**

Shipping Plate (Rounded) (Use with 2 C13-3000) **C13-4101**

#### Tools

Clutch Puller (3 Screw) **T25-1000**

Helical Insert Drill for 8-1.25mm Inserts **T10-6053**

Helical Insert Tap 8-1.25mm **T10-6254**

Helical Insert Tool 8-1.25mm - Bolt Style **T10-6554**

Piston Ring Expansion Cone (Requires T13-3010) **T25-3004**

Piston Ring Installer **T13-3010**

Shaft Seal Protector **T25-1037**

Shaft Seal Protector, Adjustable **T95-1227**

Helical Insert Repair Kit (8-1.25mm) **K10-1180**



*Includes: Helical Inserts (25), Drill (1), Tap (1), Installation Tool - Bolt Style (1)*





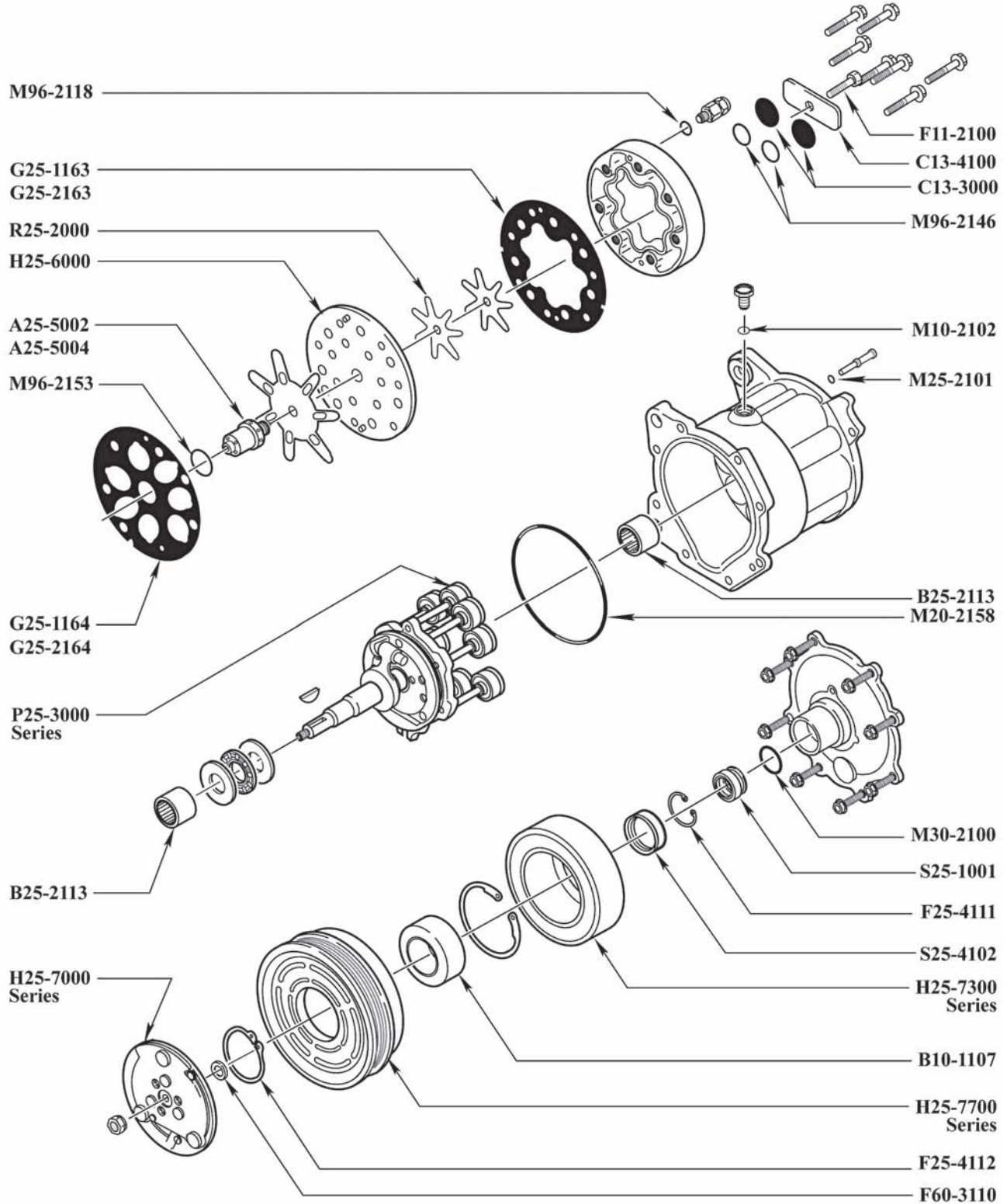

## SANDEN SD7V16



## SANDEN

### SD7V16

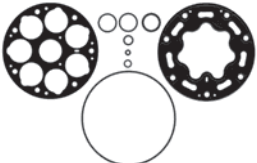
O-Rings	R134a and R-12 Compatible	Green HNBR	Black Nitrile
Case O-Ring		<b>M20-2158</b>	<b>M20-1058</b>
Control Valve O-Ring		<b>M96-2153</b>	<b>M96-1053</b>
High Pressure Relief Valve O-Ring		<b>M96-2118</b>	<b>M96-1018</b>
Internal Orifice Tube O-Ring		<b>M25-2101</b>	<b>M25-1001</b>
Lip Seal O-Ring		<b>M30-2100</b>	<b>M30-1000</b>
Oil Drain Plug O-Ring		<b>M10-2102</b>	<b>M10-1002</b>
Suction / Discharge O-Ring		<b>M96-2146</b>	<b>M96-1046</b>
<b>Bearings</b>		<b>Gaskets</b>	
Case Bearing (16mm x 22mm x 16mm)	<b>B25-2113</b>	Gasket - Head (Early)	Fiber <b>G25-1163</b>
Clutch Bearing (35mm x 55mm x 20mm)	<b>B10-1107</b>	Gasket - Cylinder	Metal <b>G25-2164</b>
<b>Chemicals</b>		Gasket - Head (Early)	Metal <b>G25-2163</b>
Ultra PAG Oil 100 - 6pk, 8 oz Bottle	<b>MT3013</b>	Gasket - Head (Late)	Metal <b>G25-2167</b>
Ultra PAG Oil 100 - 6pk, Quart Bottle	<b>MT3019</b>	Gasket Kit (Fiber)	Green HNBR <b>K25-2126</b>
Ultra PAG Oil 100 - Drum (52 gal)	<b>A10-6164</b>		
<b>Clutch Components</b>		<p>Includes: Oil Plug O-Ring (1), Head Gasket (1), Cylinder Gasket (1), Case O-Ring (1), Internal Orifice Tube O-Ring (1), Pressure Relief Valve O-Ring (1), Suction / Discharge O-Ring (2), Pressure Regulator O-Ring (1)</p>	
Clutch Coil - OD/ID: 103mm / 64mm (1100/1137/1162)	<b>H25-7301</b>	<p>Gasket Kit (Metal) Green HNBR <b>K25-2127</b></p> 	
Clutch Coil - OD/ID: 103mm / 64mm (1106/1172/1218/1227/1238)	<b>H25-7303</b>	<p>Includes: Oil Plug O-Ring (1), Head Gasket (1), Cylinder Gasket (1), Case O-Ring (1), Internal Orifice Tube O-Ring (1), Pressure Relief Valve O-Ring (1), Suction / Discharge O-Ring (2), Pressure Regulator O-Ring (1)</p>	
Clutch Coil - OD/ID: 103mm / 64mm (1206/1221/1231)	<b>H25-7302</b>	<p>Gasket Kit (Metal) - Late Model Green HNBR <b>K25-2128</b></p> 	
Clutch Coil - OD/ID: 103mm / 64mm (1215/1226/1233/1245)	<b>H25-7300</b>	<p>Includes: Oil Plug O-Ring (1), Head Gasket (1), Cylinder Gasket (1), Case O-Ring (1), Internal Orifice Tube O-Ring (1), Pressure Relief Valve O-Ring (1), Suction / Discharge O-Ring (2), Control Valve O-Ring (1)</p>	
Clutch Hub - OD: 105mm	<b>H25-7004</b>		
Clutch Hub - OD: 105mm, Offset: 14	<b>H25-7026</b>		
Clutch Hub - OD: 105mm, Offset: -3.9	<b>H25-7007</b>		
Clutch Hub - OD: 105mm, Offset: 7.8	<b>H25-7005</b>		
Clutch Hub - OD: 105mm, Spring Type	<b>H25-7006</b>		
Clutch Pulley - 6 Groove w/Bearing (119mm)	<b>H25-7702</b>		
Clutch Pulley - 6 Groove w/Bearing (127mm)	<b>H25-7706</b>		
Clutch Pulley - 8 Groove w/Bearing (123mm)	<b>H25-7708</b>		
<b>Control Valves</b>			
Internal Control Valve	<b>A25-5002</b>		
Internal Control Valve (O.E.)	<b>A25-5004</b>		
<b>Fasteners</b>			
Bolt - Shipping Plate	<b>F11-2100</b>		
Helical Insert - Rear Head / Shipping Plate (8-1.25 x 12mm)	<b>F10-6211</b>		
Retaining Ring - Clutch Pulley	<b>F25-4112</b>		
Retaining Ring - Lip Seal	<b>F25-4111</b>		
Shim - Clutch (0.13mm)	<b>F60-3110</b>		
<b>Gaskets</b>			
Gasket - Cylinder	Fiber <b>G25-1164</b>		

## SANDEN

### SD7V16

#### Gaskets

Gasket Kit (Fiber) Black Nitrile **K25-2026**

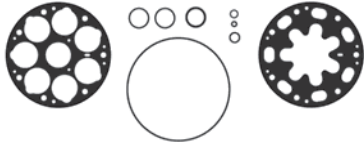

*Includes: Oil Plug O-Ring (1), Head Gasket (1), Cylinder Gasket (1), Case O-Ring (1), Internal Orifice Tube O-Ring (1), Pressure Relief Valve O-Ring (1), Suction / Discharge O-Ring (2), Pressure Regulator O-Ring (1)*

#### Piston Components

Piston Ring - 0.0345" Thick - 0.88mm	<b>P25-3035</b>
Piston Ring - 0.0430" Thick - 1.09mm	<b>P25-3043</b>
Piston Ring - Standard	<b>P25-3001</b>

#### Reeds and Valve Plates

Valve Plate	<b>H25-6000</b>
Reed - Discharge Valve	<b>R25-2000</b>
Reed - Suction Valve	<b>R25-1110</b>

#### Shaft Seals

Felt Ring	<b>S25-4102</b>
Lip Seal (Black Rubber Coated)	<b>HNBR S30-1110</b>
Lip Seal (Metal Can)	<b>HNBR S25-1001</b>
Lip Seal Kit	Black Nitrile <b>K25-3156</b>



*Includes: Lip Seal (1), Lip Seal Felt Ring (1), Lip Seal Retaining Ring (1).*

Lip Seal Kit Green HNBR **K30-1110**



*Includes: Lip Seal Retaining Ring (1), Lip Seal Metal Spacer (1), Lip Seal (1)*

#### Shipping Closures

Shipping Plate (Rectangular) (Use with 2 C13-3000) **C13-4100**

Shipping Plate (Rounded) (Use with 2 C13-3000) **C13-4101**

#### Tools

Helical Insert Drill for 8-1.25mm Inserts	<b>T10-6053</b>
Helical Insert Tap 8-1.25mm	<b>T10-6254</b>
Helical Insert Tool 8-1.25mm - Bolt Style	<b>T10-6554</b>
Piston Ring Expansion Cone (Requires T13-3010)	<b>T25-3004</b>
Piston Ring Installer	<b>T13-3010</b>
Shaft Seal Protector	<b>T25-1037</b>
Shaft Seal Protector, Adjustable	<b>T95-1229</b>
Helical Insert Repair Kit (8-1.25mm)	<b>K10-1180</b>



*Includes: Helical Inserts (25), Drill (1), Tap (1), Installation Tool - Bolt Style (1)*

#### Shipping Closures

Shipping Pad (Use with C13-4100 or C13-4101) **C13-3000**



## SANDEN

### TR70

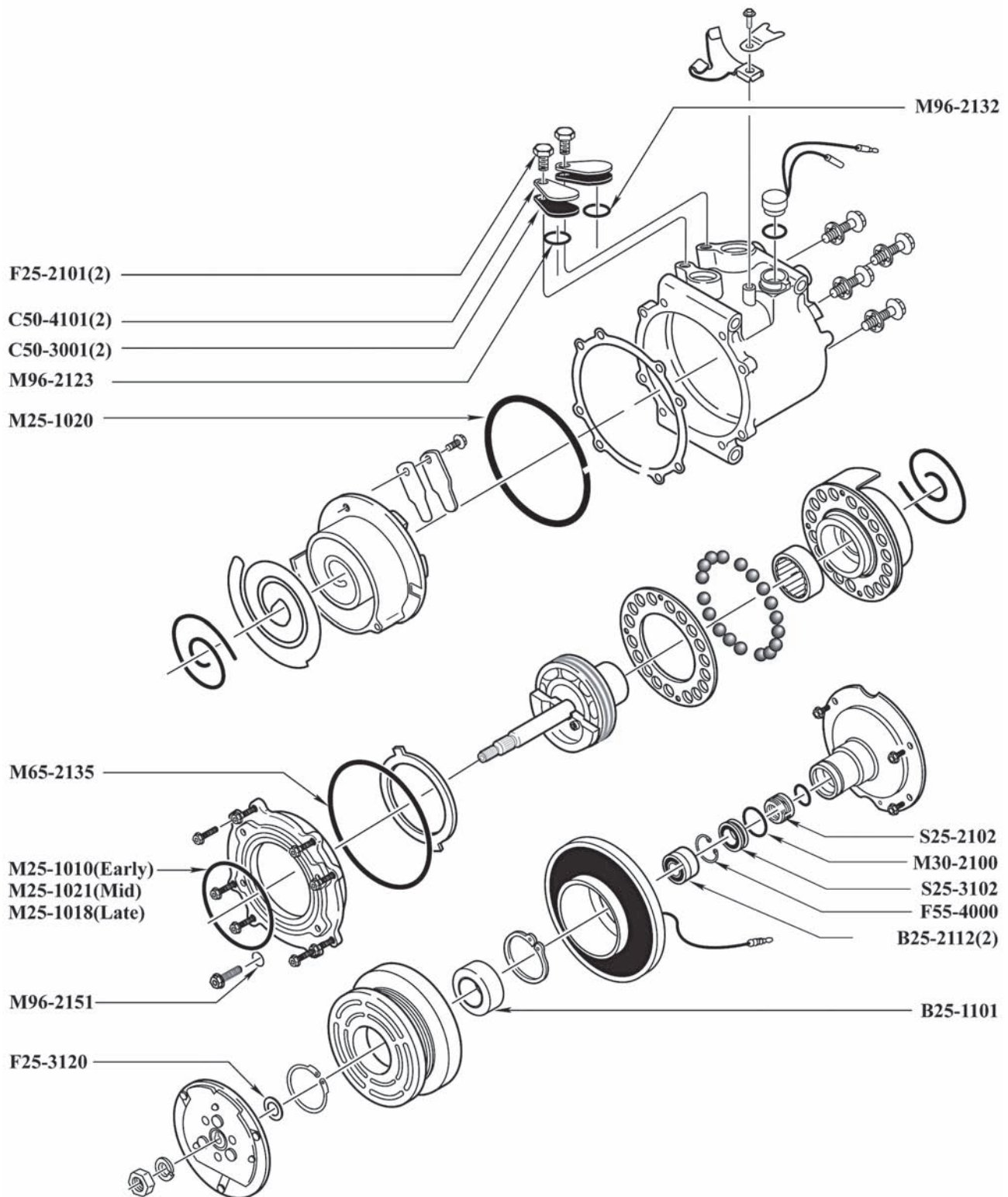

## SANDEN

### TR70

O-Rings	R134a and R-12 Compatible	Green HNBR	Black Nitrile
Carbon Shaft Seal O-Ring		<b>M65-2115</b>	<b>M65-1015</b>
Case O-Ring		<b>M65-2135</b>	<b>M65-1035</b>
Discharge Port O-Ring		<b>M96-2123</b>	<b>M96-1023</b>
Lip Seal O-Ring		<b>M96-2153</b>	<b>M96-1053</b>
Nose Piece O-Ring (Early)			<b>M25-1010</b>
Nose Piece O-Ring (Late)			<b>M25-1018</b>
Nose Piece O-Ring (Mid)			<b>M25-1021</b>
Oil Drain Plug O-Ring		<b>M96-2151</b>	<b>M96-1051</b>
Rear Scroll O-Ring			<b>M25-1020</b>
Shaft Seal Seat O-Ring		<b>M30-2100</b>	<b>M30-1000</b>
Suction Port O-Ring		<b>M96-2132</b>	<b>M96-1032</b>

#### Bearings

Nose Bearing (10mm x 26mm x 8mm)	<b>B25-2112</b>
Clutch Bearing (Unnotched) (30mm x 47mm x 18mm)	<b>B25-1101</b>

#### Chemicals

Ultra PAG Oil 46 - 6pk, 8 oz Bottle	<b>MT3012</b>
Ultra PAG Oil 46 - 6pk, Quart Bottle	<b>MT3018</b>
Ultra PAG Oil 46 - Drum (52 gal)	<b>A10-6163</b>

#### Fasteners

Bolt - Shipping Plate	<b>F25-2101</b>
Bolt - Shipping Plate (9755 Model)	<b>F11-2100</b>
Helical Insert - Rear Head / Shipping Plate (8-1.25 x 12mm)	<b>F10-6211</b>
Retaining Ring - Shaft Seal Seat	<b>F55-4000</b>
Shim - Clutch (0.25mm)	<b>F25-3120</b>

#### Gaskets

O-Ring Kit Black Nitrile **K25-2020**

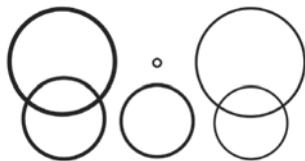

*Includes: Nose Piece O-Ring - Early Models (1), Orbiting Rotor Body O-Ring (1), Nose Piece O-Ring - Mid Models (1), Nose Piece O-Ring - Late Model (1), Scroll to Rear Housing O-Ring (1), Oil Drain Bolt O-Ring (1)*

#### Shaft Seals

Carbon Shaft Seal	HNBR <b>S25-2102</b>
Lip Seal	Nitrile <b>S25-1000</b>
Metal Shaft Seal Seat	<b>S25-3102</b>

#### Shaft Seals

Carbon Shaft Seal Kit Green HNBR **K25-3110**



*Includes: Carbon Shaft Seal (1), Mini Metal Shaft Seal Seat (1), Metal Shaft Seal Seat O-Ring (1)*

#### Lip Seal Kit

Black Nitrile **K55-3110**



*Includes: Lip Seal Retaining Ring (1), Lip Seal (1)*

#### Shipping Closures

Shipping Pad (Use with C11-4103)	<b>C11-3103</b>
Shipping Pad (Use with C50-4101)	<b>C50-3001</b>
Shipping Plate (Use with C11-3103)	<b>C11-4103</b>
Shipping Plate (Use with C50-3001)	<b>C50-4101</b>
Shipping Plate (Use with C95-3004 & C95-3006)	<b>C95-4001</b>
Shipping Plug (Discharge) (Use with C95-4001)	<b>C95-3004</b>
Shipping Plug (Suction) (Use with C95-4001)	<b>C95-3006</b>

#### Tools

Helical Insert Drill for 8-1.25mm Inserts	<b>T10-6053</b>
Helical Insert Tap 8-1.25mm	<b>T10-6254</b>
Shaft Seal Installer / Remover	<b>T25-1030</b>
Shaft Seal Protector	<b>T25-1037</b>
Shaft Seal Protector, Adjustable	<b>T95-1221</b>

## SANDEN

### TR090, TRF090, TRS090

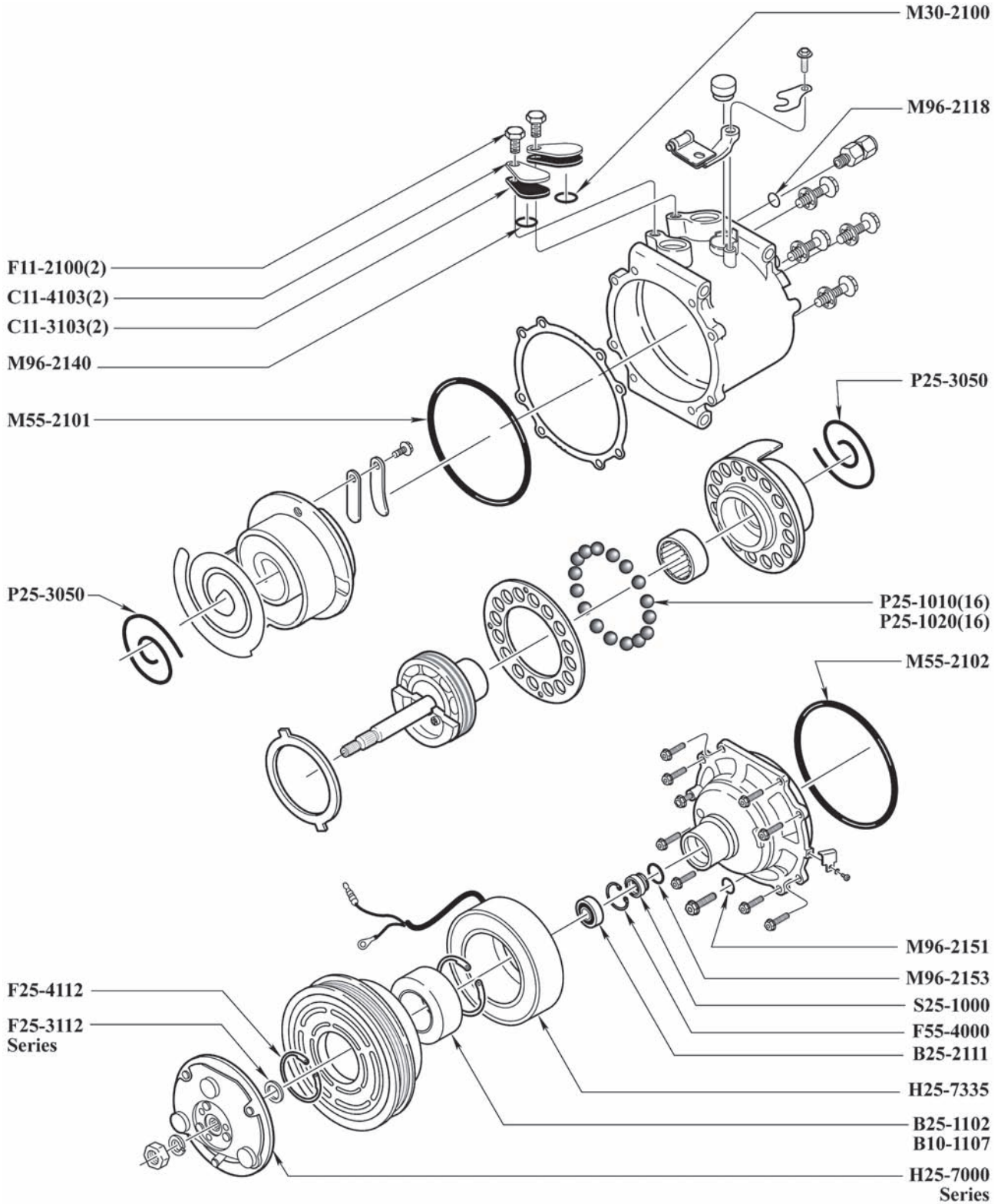



## SANDEN

### TR090, TRF090, TRS090

O-Rings	R134a and R-12 Compatible	Green HNBR	Black Nitrile
Carbon Shaft Seal O-Ring		<b>M65-2115</b>	<b>M65-1015</b>
Discharge Port O-Ring		<b>M96-2140</b>	<b>M96-1040</b>
Front Nose O-Ring		<b>M55-2102</b>	
High Pressure Relief Valve O-Ring		<b>M96-2118</b>	<b>M96-1018</b>
Lip Seal O-Ring		<b>M96-2153</b>	<b>M96-1053</b>
Oil Drain Plug O-Ring		<b>M96-2151</b>	<b>M96-1051</b>
Rear Scroll O-Ring		<b>M55-2101</b>	
Suction Port O-Ring/Shaft Seal Seat O-Ring		<b>M30-2100</b>	<b>M30-1000</b>

#### Bearings

Nose Bearing (12mm x 28mm x 8mm)	<b>B25-2111</b>
Clutch Bearing (35mm x 50mm x 20mm)	<b>B25-1102</b>
Clutch Bearing (35mm x 55mm x 20mm)	<b>B10-1107</b>

#### Chemicals

Ultra PAG Oil 46 - 6pk, 8 oz Bottle	<b>MT3012</b>
Ultra PAG Oil 46 - 6pk, Quart Bottle	<b>MT3018</b>
Ultra PAG Oil 46 - Drum (52 gal)	<b>A10-6163</b>

#### Clutch Components

Clutch Coil - OD/ID: 86.5mm / 59mm (4993)	<b>H25-7335</b>
Clutch Hub - OD: 105mm, Offset: 6.8	<b>H25-7035</b>
Clutch Hub - OD: 109mm, Offset: 12	<b>H25-7032</b>

#### Fasteners

Bolt - Shipping Plate	<b>F11-2100</b>
Helical Insert - Rear Head / Shipping Plate (8-1.25 x 12mm)	<b>F10-6211</b>
Retaining Ring - Clutch Pulley	<b>F25-4112</b>
Retaining Ring - Shaft Seal Seat	<b>F55-4000</b>
Shim - Clutch (0.38mm)	<b>F25-3112</b>
Shim - Clutch (0.76mm)	<b>F25-3113</b>

#### Gaskets

O-Ring Kit	Green HNBR <b>K25-2131</b>
------------	----------------------------



Includes: Rear Stationary Scroll O-Ring (1), Front Nose O-Ring (1), Pressure Relief Valve O-Ring (1), Oil Drain Plug O-Ring (1)

#### Piston Components

Rotor Ball (10.31mm) (16/Unit)	<b>P25-1010</b>
Rotor Ball (11.05mm) (16/Unit)	<b>P25-1020</b>
Scroll Rings (Set of 2)(TRF090)	<b>P25-3050</b>
Scroll Set - w/ Pins and Scroll Rings	<b>P25-4000</b>

#### Shaft Seals

Carbon Shaft Seal	HNBR <b>S25-2102</b>
Lip Seal	Nitrile <b>S25-1000</b>
Metal Shaft Seal Seat	<b>S25-3102</b>
Carbon Shaft Seal Kit	Green HNBR <b>K25-3110</b>



Includes: Carbon Shaft Seal (1), Mini Metal Shaft Seal Seat (1), Metal Shaft Seal Seat O-Ring (1)

#### Lip Seal Kit

Black Nitrile **K55-3110**



Includes: Lip Seal Retaining Ring (1), Lip Seal (1)

#### Shipping Closures

Shipping Pad (Use with C11-4103)	<b>C11-3103</b>
Shipping Pad (Use with C25-4105)	<b>C13-3000</b>
Shipping Pad (Use with C50-4101)	<b>C50-3001</b>
Shipping Plate (Use with 2 C13-3000)	<b>C25-4105</b>
Shipping Plate (Use with C11-3103)	<b>C11-4103</b>
Shipping Plate (Use with C50-3001)	<b>C50-4101</b>
Shipping Plate (Use with C95-3002/3003/3004/3006)	<b>C95-4001</b>
Shipping Plug (Discharge) (Use with C95-4001) (TR090)	<b>C95-3002</b>
Shipping Plug (Discharge) (Use with C95-4001)(TRF090/TRS090)	<b>C95-3004</b>
Shipping Plug (Suction) (Use with C95-4001) (TR090)	<b>C95-3003</b>

## SANDEN

TR090, TRF090, TRS090

### Shipping Closures

Shipping Plug (Suction) (Use with C95-4001) **C95-3006**  
(TRF090/TRS090)

### Tools

Helical Insert Drill for 8-1.25mm Inserts **T10-6053**

Helical Insert Tap 8-1.25mm **T10-6254**

Helical Insert Tool 8-1.25mm - Bolt Style **T10-6554**

Shaft Seal Installer / Remover **T25-1030**

Shaft Seal Protector **T25-1037**

Shaft Seal Protector, Adjustable **T95-1225**

Helical Insert Repair Kit (8-1.25mm) **K10-1180**



*Includes: Helical Inserts (25), Drill (1), Tap (1), Installation Tool - Bolt Style (1)*



## SANDEN

TR105, TR105VS, TRF105, TRS105

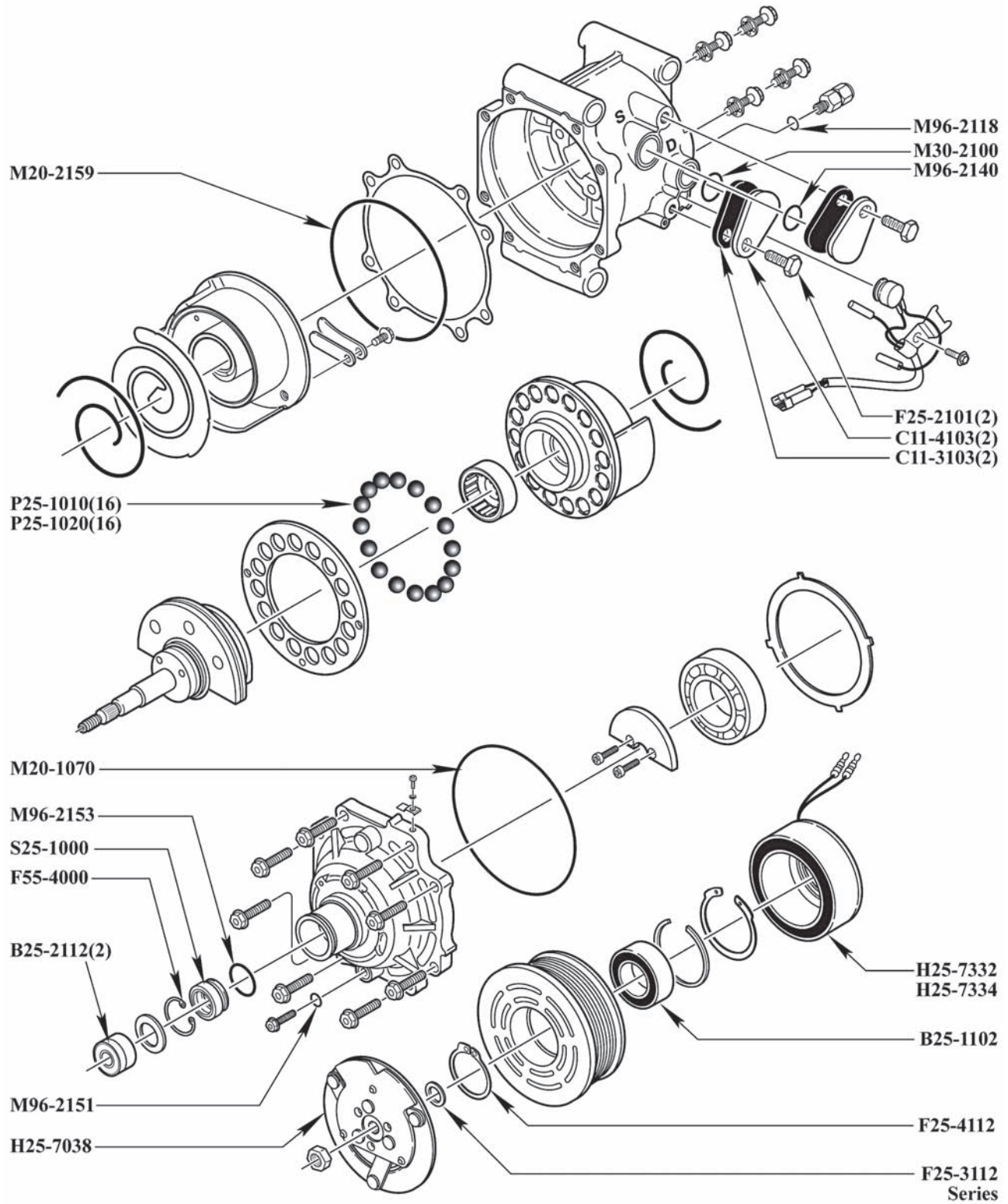

## SANDEN

TR105, TR105VS, TRF105, TRS105

O-Rings	R134a and R-12 Compatible	Green HNBR	Black Nitrile
Carbon Shaft Seal O-Ring		<b>M65-2115</b>	<b>M65-1015</b>
Case O-Ring			<b>M20-1070</b>
Discharge Port O-Ring		<b>M96-2140</b>	<b>M96-1040</b>
High Pressure Relief Valve O-Ring		<b>M96-2118</b>	<b>M96-1018</b>
Lip Seal O-Ring		<b>M96-2153</b>	<b>M96-1053</b>
Oil Drain Plug O-Ring		<b>M96-2151</b>	<b>M96-1051</b>
Rear Scroll O-Ring		<b>M20-2159</b>	<b>M20-1059</b>
Suction Port O-Ring/Metal Shaft Seat O-Ring		<b>M30-2100</b>	<b>M30-1000</b>

### Bearings

Nose Bearing (10mm x 26mm x 8mm)	<b>B25-2112</b>
Clutch Bearing (35mm x 50mm x 20mm)	<b>B25-1102</b>

### Chemicals

Ultra PAG Oil 46 - 6pk, 8 oz Bottle	<b>MT3012</b>
Ultra PAG Oil 46 - 6pk, Quart Bottle	<b>MT3018</b>
Ultra PAG Oil 46 - Drum (52 gal)	<b>A10-6163</b>

### Clutch Components

Clutch Coil - OD/ID: 86.3mm / 59mm (01-97 Honda Civic Gold)	<b>H25-7332</b>
Clutch Coil - OD/ID: 86.3mm / 59mm (3211)	<b>H25-7334</b>
Clutch Hub - OD: 105mm	<b>H25-7038</b>

### Fasteners

Bolt - Shipping Plate	<b>F25-2101</b>
Retaining Ring - Clutch Pulley	<b>F25-4112</b>
Retaining Ring - Shaft Seal Seat	<b>F55-4000</b>
Shim - Clutch (0.38mm)	<b>F25-3112</b>
Shim - Clutch (0.76mm)	<b>F25-3113</b>

### Gaskets

O-Ring Kit	Black Nitrile <b>K25-2032</b>
------------	-------------------------------

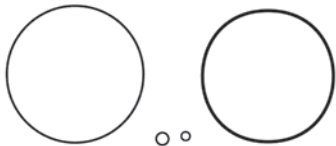

Includes: Rear Stationary Scroll O-Ring (1), Front Case O-Ring (1), Pressure Relief Valve O-Ring (1), Oil Drain Plug O-Ring (1).

### Piston Components

Rotor Ball (10.31mm) (16/Unit)	<b>P25-1010</b>
Rotor Ball (11.05mm) (16/Unit)	<b>P25-1020</b>

### Shaft Seals

Carbon Shaft Seal	HNBR <b>S25-2102</b>
Lip Seal	Nitrile <b>S25-1000</b>
Metal Shaft Seal Seat	<b>S25-3102</b>

### Shaft Seals

Carbon Shaft Seal Kit	Green HNBR <b>K25-3110</b>
-----------------------	----------------------------



Includes: Carbon Shaft Seal (1), Mini Metal Shaft Seal Seat (1), Metal Shaft Seal Seat O-Ring (1)

### Lip Seal Kit

Lip Seal Kit	Black Nitrile <b>K55-3110</b>
--------------	-------------------------------



Includes: Lip Seal Retaining Ring (1), Lip Seal (1)

### Shipping Closures

Shipping Pad (Use with C11-4103)	<b>C11-3103</b>
Shipping Pad (Use with C50-4101)	<b>C50-3001</b>
Shipping Plate (Use with C11-3103)	<b>C11-4103</b>
Shipping Plate (Use with C50-3001)	<b>C50-4101</b>

### Tools

Lip Seal Protector (16 Spline) (Metal)	<b>T12-1003</b>
Shaft Seal Installer / Remover	<b>T25-1030</b>
Shaft Seal Protector	<b>T25-1037</b>
Shaft Seal Protector, Adjustable	<b>T95-1221</b>

## SANDEN

### TRSA09, TRSA12, TRSE07

Suction/Discharge Plugs and Pads  
for TRSE07 and TRSA09

F20-2110  
C95-4001  
C95-3005

F20-2110  
C95-4001  
C95-3003

C13-5102(TRSA12)  
M96-2140(TRSA12)  
M30-2100(TRSA12)

M11-2106  
(TRSE07)

M20-2159  
(TRSA12)  
M55-2101  
(TRSE07 and TRSA09)  
M25-2101

M96-2118(4)  
A10-5122  
M96-2151

P25-3050

P25-3050

M20-1065(TRSA12)  
M20-2140(TRSE07 and TRSA09)

F20-2110(8)  
S55-1001  
F55-4000

B25-2112(TRSE07)  
B25-2111(TRSA09/12)

M96-2151

B25-1102(TRSA12)  
B10-1107(TRSA09/TRSE07)

F25-3112  
Series

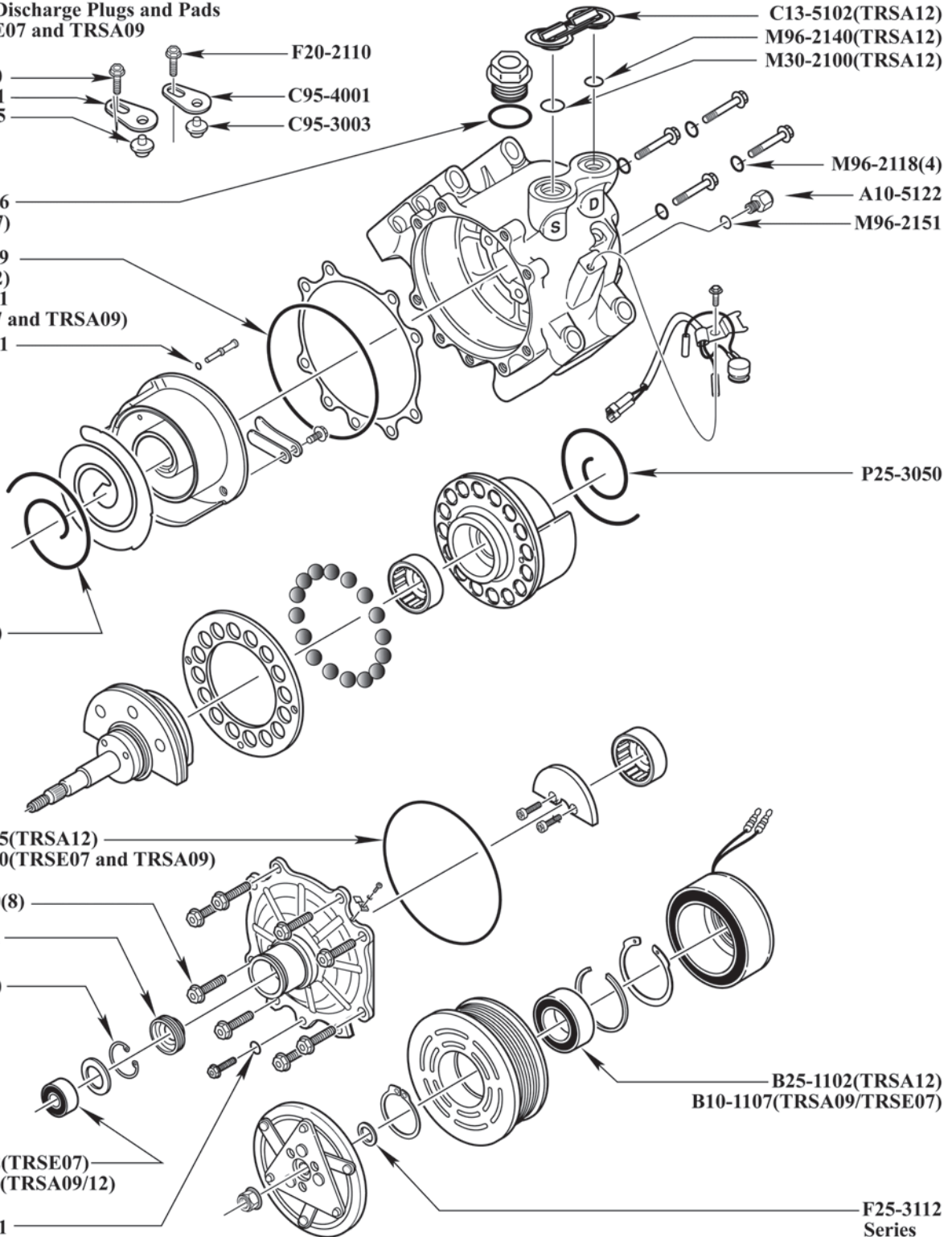

## SANDEN

### TRSA09, TRSA12, TRSE07

O-Rings	R134a and R-12 Compatible	Green HNBR	Black Nitrile
Case O-Ring (Front) (TRSA12)			<b>M20-1065</b>
Case O-Ring (Front) (TRSE07/TRSA09)		<b>M20-2140</b>	<b>M20-1040</b>
Discharge Port O-Ring (TRSA12)		<b>M96-2140</b>	<b>M96-1040</b>
Head Bolt O-Ring, Front		<b>M96-2151</b>	<b>M96-1051</b>
Head Bolt O-Ring, Rear		<b>M96-2118</b>	<b>M96-1018</b>
Internal Orifice Tube O-Ring		<b>M25-2101</b>	<b>M25-1001</b>
Plug O-Ring(TRSE07)		<b>M11-2106</b>	<b>M11-1006</b>
Pressure Relief Valve O-Ring		<b>M96-2111</b>	
Rear Scroll O-Ring (TRSA12)		<b>M20-2159</b>	<b>M20-1059</b>
Rear Scroll O-Ring (TRSE07/TRSA09)		<b>M55-2101</b>	
Suction Port O-Ring (TRSA12)		<b>M30-2100</b>	<b>M30-1000</b>

#### Bearings

Clutch Bearing (35mm x 48mm x 20mm) (TRSE07 Honda Civic)	<b>B25-1104</b>
Nose Bearing (10mm x 26mm x 8mm) (TRSE07)	<b>B25-2112</b>
Nose Bearing (10mm x 28mm x 8mm) (TRSE07)	<b>B25-2114</b>
Nose Bearing (12mm x 28mm x 8mm) (TRSA)	<b>B25-2111</b>
Clutch Bearing (35mm x 50mm x 20mm) (TRSA12)	<b>B25-1102</b>
Clutch Bearing (35mm x 55mm x 20mm) (TRSA09/TRSE07)	<b>B10-1107</b>

#### Chemicals

Ultra PAG Oil 46 - 6pk, 8 oz Bottle	<b>MT3012</b>
Ultra PAG Oil 46 - 6pk, Quart Bottle	<b>MT3018</b>
Ultra PAG Oil 46 - Drum (52 gal)	<b>A10-6163</b>

#### Clutch Components

Clutch Coil - OD/ID: 81.5mm / 58mm (Honda)	<b>H25-7384</b>
Clutch Coil - OD/ID: 86.3mm / 59mm (4901)	<b>H25-7389</b>
Clutch Hub - OD: 105mm, Offset: 6.8	<b>H25-7035</b>

#### Fasteners

Bolt - Head/Shipping	<b>F20-2110</b>
Retaining Ring - Lip Seal	<b>F55-4000</b>
Shim - Clutch (0.38mm)	<b>F25-3112</b>
Shim - Clutch (0.76mm)	<b>F25-3113</b>

#### Gaskets

Gasket Kit - O-Rings (TRSA12) Green HNBR **K25-2150**

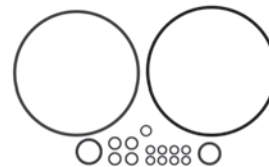

*Includes: Front Head O-Ring(1), Scroll Rear O-Ring(1), Suction Port O-Ring(1), Front Head Bolt O-Ring(8), Rear Head Bolt O-Ring(4), PRV O-Ring(1), Discharge Port O-Ring(1)*

Gasket Kit - O-Rings (TRSE07 / TRSA09) Green HNBR **K25-2151**

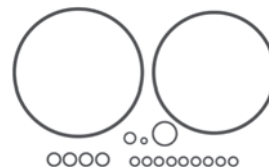

*Includes: Front Head O-Ring(1), Scroll Rear O-Ring(1), Front Head Bolt O-Ring(9), Rear Head Bolt O-Ring(4), PRV O-Ring(1), Internal Orifice Tube O-Ring(1), Plug O-Ring(1)*

#### Piston Components

Scroll Rings (Set of 2) **P25-3050**

#### Service Items

High Pressure Relief Valve 3/8-24 **A10-5122**

#### Shaft Seals

Lip Seal (Black Rubber) Nitrile **S55-1001**

## SANDEN

TRSA09, TRSA12, TRSE07

### Shaft Seals

Lip Seal Kit (Rubber Coated Seal)      Black Nitrile **K55-3006**



*Includes: Lip Seal Retaining Ring (1), Lip Seal (1)*

### Shipping Closures

Shipping Closure - 3/4" S / 5/8" D (TRSA12)	<b>C13-5102</b>
Shipping Plate (Use with C95-3003 & C95-3005)(TRSE07/TRSA09)	<b>C95-4001</b>
Shipping Plug (Discharge) (Use with C95-4001)(TRSE07/TRSA09)	<b>C95-3003</b>
Shipping Plug (Suction) (Use with C95-4001)(TRSE07/TRSA09)	<b>C95-3005</b>





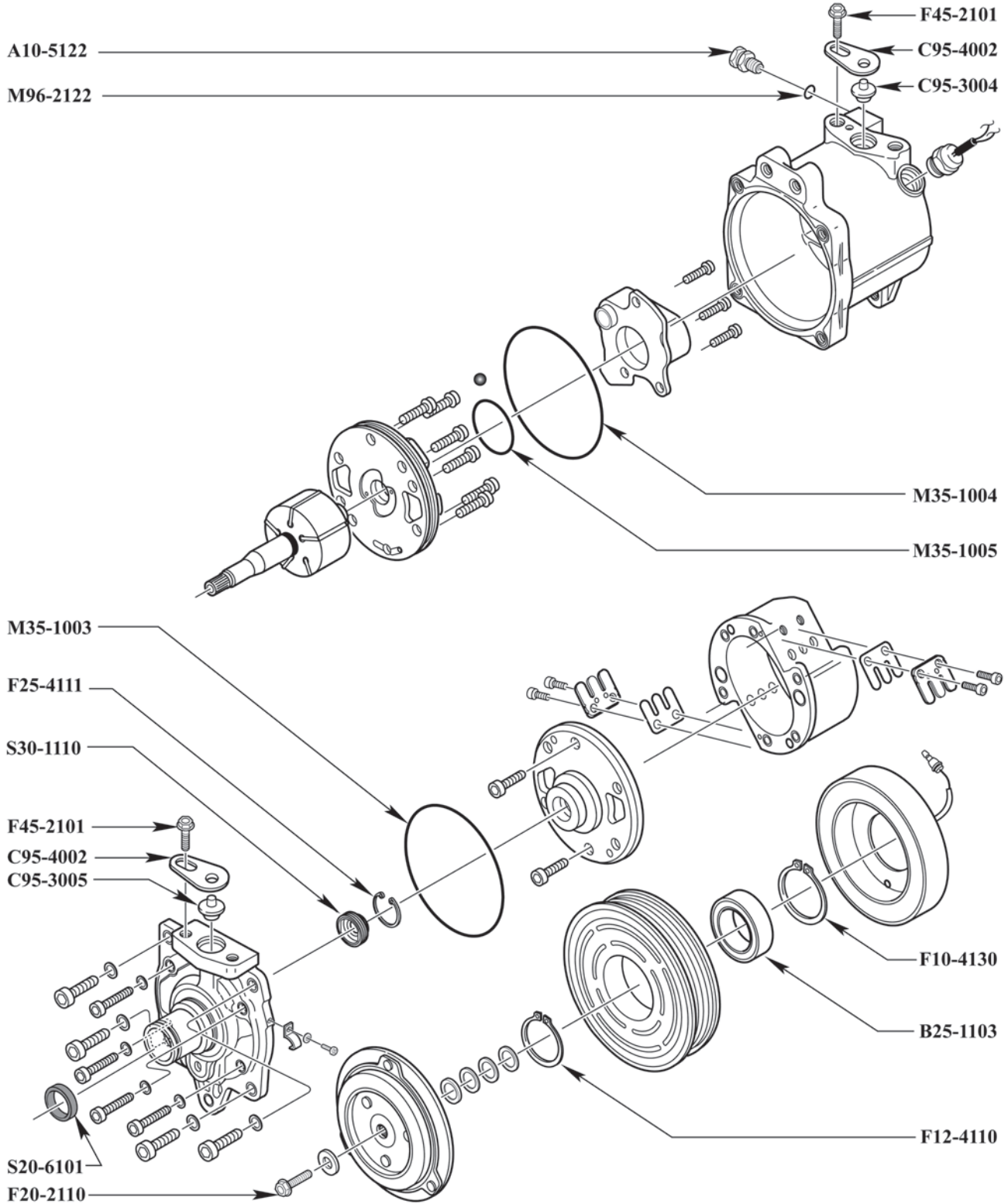

## SEIKO-SEIKI

SS10LV6, SS10V1, SS10V6



## SEIKO-SEIKI

SS10LV6, SS10V1, SS10V6

O-Rings	R134a and R-12 Compatible	Green HNBR	Black Nitrile
Front Case O-Ring			<b>M35-1003</b>
Pressure Relief Valve O-Ring		<b>M96-2122</b>	<b>M96-1022</b>
Rear Case O-Ring			<b>M35-1004</b>
Rotor Body Rear O-Ring			<b>M35-1005</b>
<b>Bearings</b>		<b>Tools</b>	
Clutch Bearing (32mm x 47mm x 18mm)	<b>B25-1103</b>	Helical Insert Repair Kit (8-1.25mm)	<b>K10-1180</b>
<b>Chemicals</b>		 <p><i>Includes: Helical Inserts (25), Drill (1), Tap (1), Installation Tool - Bolt Style (1)</i></p>	
Ultra PAG Oil 100 - 6pk, 8 oz Bottle	<b>MT3013</b>		
Ultra PAG Oil 100 - 6pk, Quart Bottle	<b>MT3019</b>		
Ultra PAG Oil 100 - Drum (52 gal)	<b>A10-6164</b>		
<b>Fasteners</b>			
Bolt - Shaft	<b>F20-2110</b>		
Bolt - Shipping Plate	<b>F45-2101</b>		
Helical Insert - Rear Head / Shipping Plate (8-1.25 x 12mm)	<b>F10-6211</b>		
Retaining Ring - Clutch Coil	<b>F10-4130</b>		
Retaining Ring - Lip Seal	<b>F25-4111</b>		
Retaining Ring - Pulley	<b>F12-4110</b>		
<b>Service Items</b>			
High Pressure Relief Valve 3/8-24 w/Non-Captive O-Ring	<b>A10-5122</b>		
<b>Shaft Seals</b>			
Felt Wiper	<b>S20-6101</b>		
Lip Seal (Black Rubber Coated)	HNBR <b>S30-1110</b>		
Lip Seal Kit	Green HNBR <b>K30-1110</b>		
 <p><i>Includes: Lip Seal Retaining Ring (1), Lip Seal Metal Spacer (1), Lip Seal (1)</i></p>			
<b>Shipping Closures</b>			
Shipping Plate (Use with C95-3004/3005)	<b>C95-4002</b>		
Shipping Plug (Discharge) (Use with C95-4002)	<b>C95-3004</b>		
Shipping Plug (Suction) (Use with C95-4002)	<b>C95-3005</b>		
<b>Tools</b>			
Helical Insert Drill for 8-1.25mm Inserts	<b>T10-6053</b>		
Helical Insert Tap 8-1.25mm	<b>T10-6254</b>		
Helical Insert Tool 8-1.25mm - Bolt Style	<b>T10-6554</b>		
Shaft Seal Protector, Adjustable	<b>T95-1229</b>		

## SEIKO-SEIKI

SS96D1, SS96D2

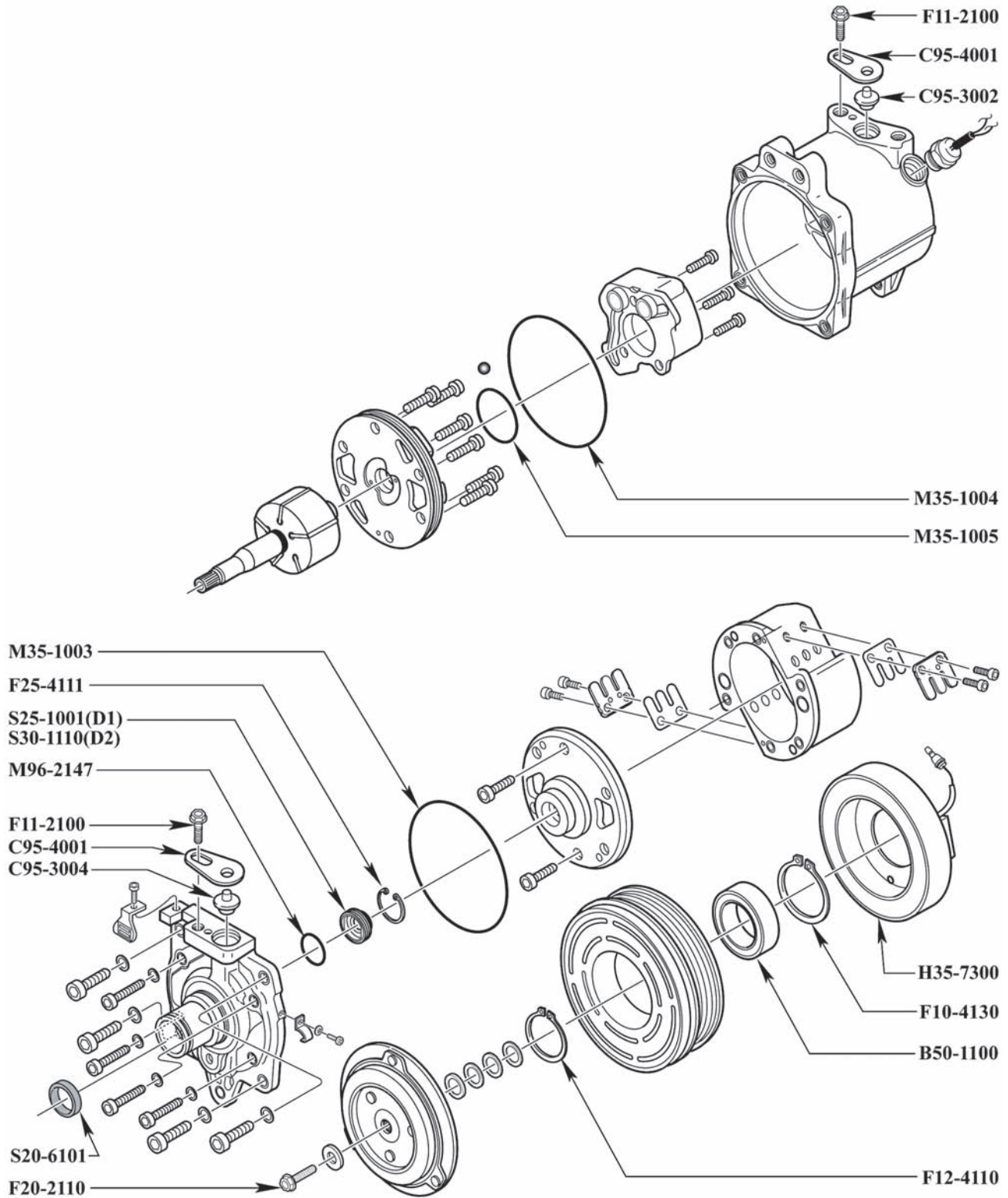

## SEIKO-SEIKI

SS96D1, SS96D2

O-Rings	R134a and R-12 Compatible	Green HNBR	Black Nitrile
Front Case O-Ring			<b>M35-1003</b>
Lip Seal O-Ring (D1)		<b>M96-2147</b>	
Rear Case O-Ring			<b>M35-1004</b>
Rotor Body Rear O-Ring			<b>M35-1005</b>
<b>Bearings</b>		<b>Shipping Closures</b>	
Clutch Bearing (32mm x 55mm x 23mm)	<b>B50-1100</b>	Shipping Pad (Use with C50-4101)	<b>C50-3001</b>
<b>Chemicals</b>		Shipping Plate (Use with C50-3001)	<b>C50-4101</b>
Ultra PAG Oil 100 - 6pk, 8 oz Bottle	<b>MT3013</b>	Shipping Plate (Use with C95-3002 & C95-3004)	<b>C95-4001</b>
Ultra PAG Oil 100 - 6pk, Quart Bottle	<b>MT3019</b>	Shipping Plug (Discharge) (Use with C95-4001)	<b>C95-3002</b>
Ultra PAG Oil 100 - Drum (52 gal)	<b>A10-6164</b>	Shipping Plug (Suction) (Use with C95-4001)	<b>C95-3004</b>
<b>Clutch Components</b>		<b>Tools</b>	
Clutch Coil w/ Diode - OD/ID: 95.7mm / 64mm	<b>H35-7300</b>	Helical Insert Drill for 8-1.25mm Inserts	<b>T10-6053</b>
<b>Fasteners</b>		Helical Insert Tap 8-1.25mm	<b>T10-6254</b>
Bolt - Shaft	<b>F20-2110</b>	Helical Insert Tool 8-1.25mm - Bolt Style	<b>T10-6554</b>
Bolt - Shipping Plate	<b>F11-2100</b>	Shaft Seal Protector, Adjustable	<b>T95-1226</b>
Helical Insert - Rear Head / Shipping Plate (8-1.25 x 12mm)	<b>F10-6211</b>	Helical Insert Repair Kit (8-1.25mm)	<b>K10-1180</b>
Retaining Ring - Lip Seal	<b>F25-4111</b>		
Retaining Ring - Pulley	<b>F10-4130</b>		
Retaining Ring - Pulley	<b>F12-4110</b>		
<b>Shaft Seals</b>			
Felt Ring	<b>S25-4102</b>		
Felt Wiper	<b>S20-6101</b>		
Lip Seal (Black Rubber Coated) (D2)	HNBR <b>S30-1110</b>		
Lip Seal (D1)	HNBR <b>S25-1001</b>		
Lip Seal Spacer (Use with S30-1110)(D2)	<b>S30-6000</b>		
Lip Seal Kit	Black Nitrile <b>K25-3156</b>		



Includes: Helical Inserts (25), Drill (1), Tap (1), Installation Tool - Bolt Style (1)



Includes: Lip Seal (1), Lip Seal Felt Ring (1), Lip Seal Retaining Ring (1).

Lip Seal Kit Green HNBR **K30-1110**



Includes: Lip Seal Retaining Ring (1), Lip Seal Metal Spacer (1), Lip Seal (1)

## SEIKO-SEIKI

SS121DN1, SS121DN2, SS121DV2

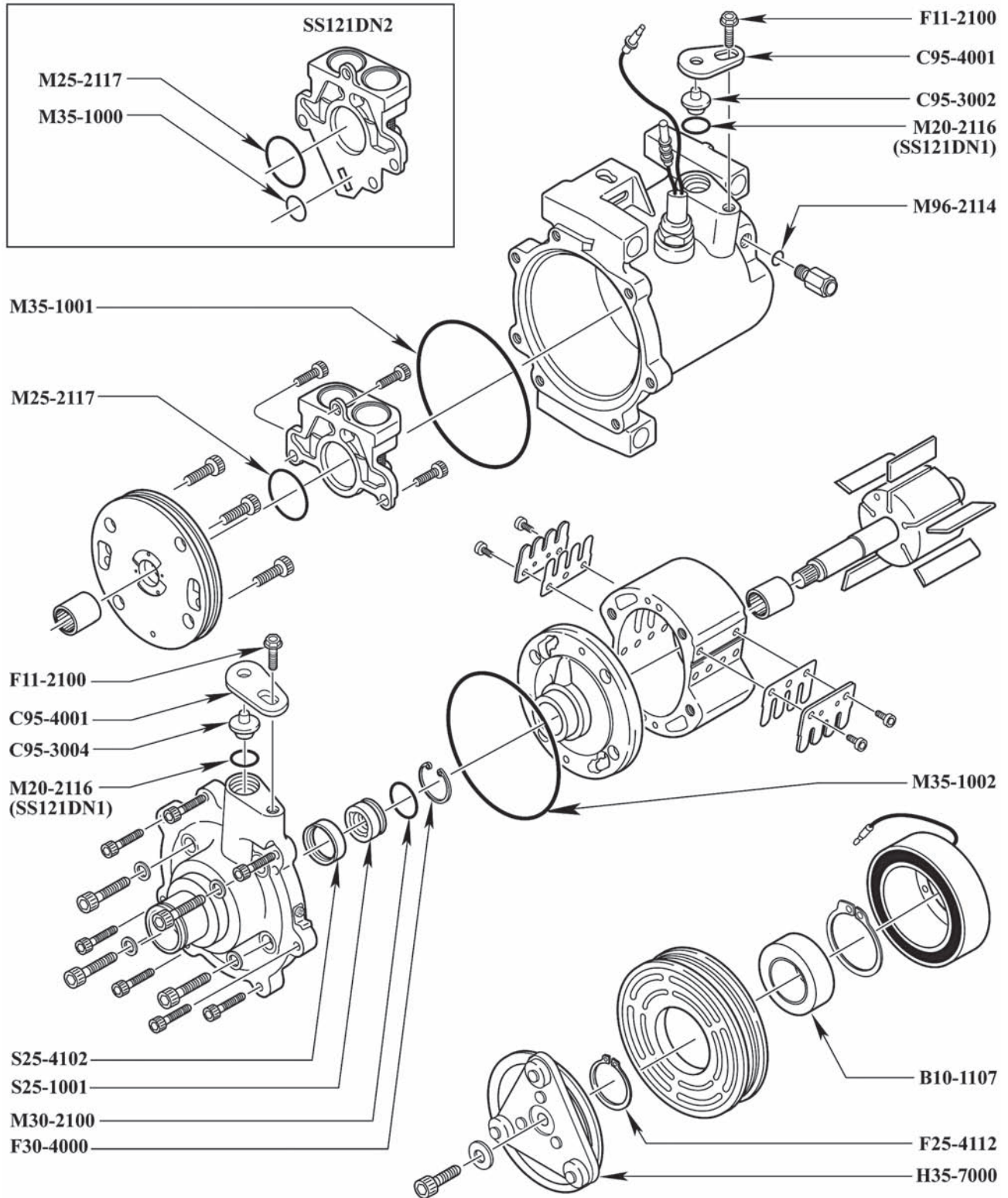

## SEIKO-SEIKI

### SS121DN1, SS121DN2, SS121DV2

O-Rings	R134a and R-12 Compatible	Green HNBR	Black Nitrile
Case O-Ring (Front)			<b>M35-1002</b>
Case O-Ring (Rear)			<b>M35-1001</b>
Lip Seal O-Ring		<b>M30-2100</b>	<b>M30-1000</b>
Pressure Relief Valve O-Ring		<b>M96-2114</b>	
Rear Internal Screen Body O-Ring		<b>M25-2117</b>	<b>M25-1017</b>
Rear Internal Suction O-Ring (DN2)			<b>M35-1000</b>
Suction and Discharge Port O-Ring (DN1)		<b>M20-2116</b>	<b>M20-1016</b>

#### Bearings

Clutch Bearing (35mm x 55mm x 20mm) **B10-1107**

#### Chemicals

Ultra PAG Oil 100 - 6pk, 8 oz Bottle **MT3013**

Ultra PAG Oil 100 - 6pk, Quart Bottle **MT3019**

Ultra PAG Oil 100 - Drum (52 gal) **A10-6164**

#### Clutch Components

Clutch Hub - OD: 109.5mm **H35-7000**

#### Fasteners

Bolt - Shipping Plate **F11-2100**

Helical Insert - Rear Head / Shipping Plate (8-1.25 x 12mm) **F10-6211**

Retaining Ring - Lip Seal **F25-4111**

Retaining Ring - Lip Seal **F30-4000**

Retaining Ring - Pulley **F25-4112**

#### Gaskets

O-Ring Kit Black Nitrile **K35-2007**

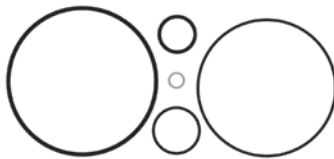

*Includes: Rear Internal Screen Body O-Ring (1), Rear Case O-Ring (1), Front Case O-Ring(1), Pressure Relief Valve O-Ring (1), Lip Seal O-Ring (1)*

#### Shaft Seals

Felt Ring **S25-4102**

Lip Seal HNBR **S25-1001**

Lip Seal Kit (Late) Black Nitrile **K25-3156**



*Includes: Lip Seal (1), Lip Seal Felt Ring (1), Lip Seal Retaining Ring (1).*

#### Shipping Closures

Shipping Plate (Use with C95-3002 & C95-3004) **C95-4001**

Shipping Plug (Discharge) (Use with C95-4001) **C95-3002**

Shipping Plug (Suction) (Use with C95-4001) **C95-3004**

#### Tools

Helical Insert Drill for 8-1.25mm Inserts **T10-6053**

Helical Insert Tap 8-1.25mm **T10-6254**

Helical Insert Tool 8-1.25mm - Bolt Style **T10-6554**

Shaft Seal Protector, Adjustable **T95-1226**

Helical Insert Repair Kit (8-1.25mm) **K10-1180**



*Includes: Helical Inserts (25), Drill (1), Tap (1), Installation Tool - Bolt Style (1)*

## SEIKO-SEIKI

### SS170PSS

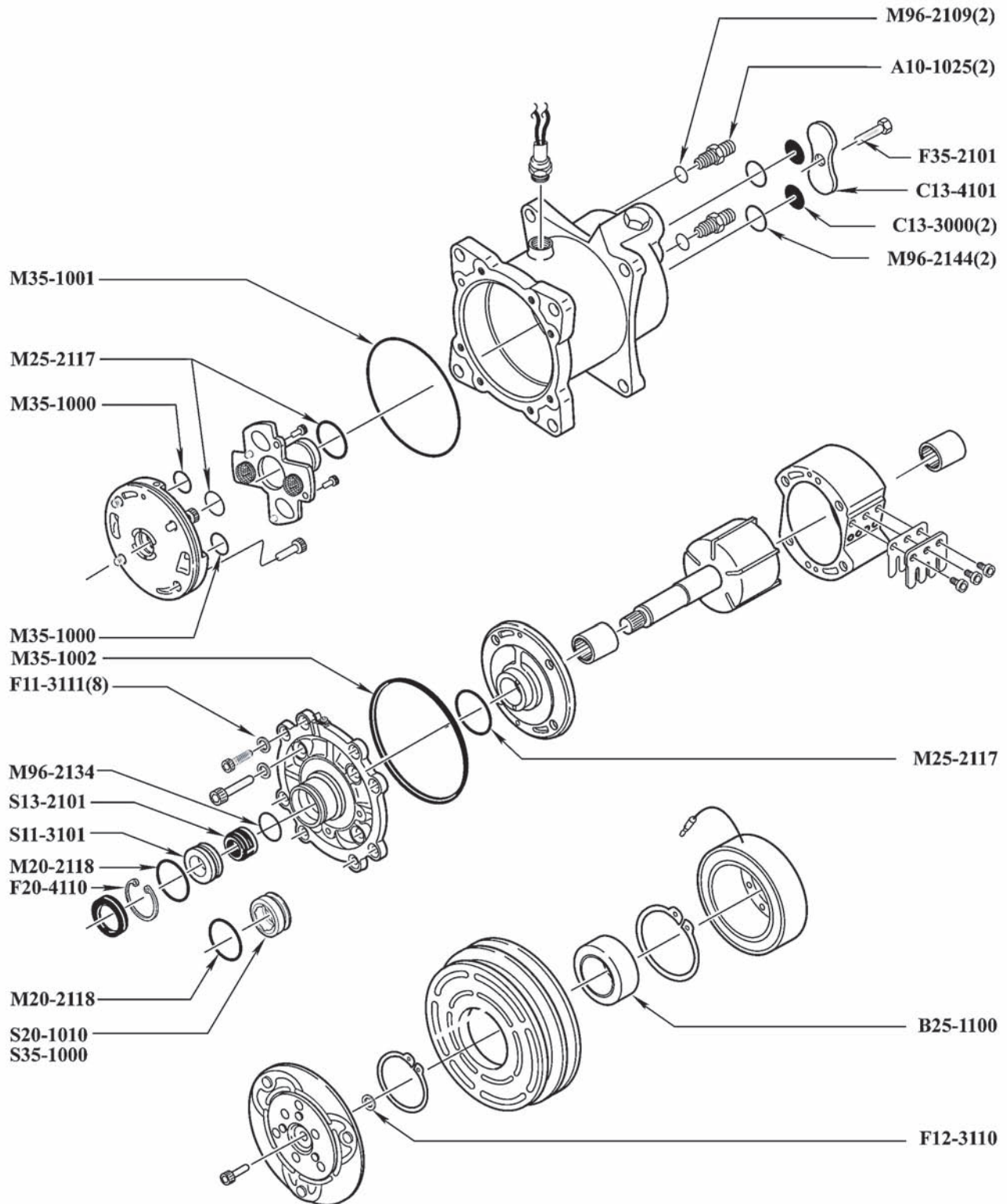



## SEIKO-SEIKI

### SS170PSS

O-Rings	R134a and R-12 Compatible	Green HNBR	Black Nitrile
Carbon Shaft Seal O-Ring		<b>M96-2134</b>	<b>M96-1034</b>
Case O-Ring (Center)			<b>M35-1001</b>
Case O-Ring (Front)			<b>M35-1002</b>
Internal Rotor O-Ring		<b>M25-2117</b>	<b>M25-1017</b>
Internal Suction O-Ring			<b>M35-1000</b>
Service Port O-Ring		<b>M96-2109</b>	<b>M96-1009</b>
Shaft Seal Seat/Lip Seal O-Ring		<b>M20-2118</b>	<b>M20-1018</b>
Suction / Discharge Port O-Ring		<b>M96-2144</b>	<b>M96-1044</b>

#### Bearings

Clutch Bearing (40mm x 62mm x 24mm) **B25-1100**

#### Chemicals

Ultra PAG Oil 100 - 6pk, 8 oz Bottle **MT3013**

Ultra PAG Oil 100 - 6pk, Quart Bottle **MT3019**

Ultra PAG Oil 100 - Drum (52 gal) **A10-6164**

#### Fasteners

Bolt - Shipping Plate **F35-2101**

Retaining Ring - Lip Seal **F20-4110**

Shim - Clutch (0.38mm) **F12-3110**

Washer - Head Bolt **F11-3111**

#### Gaskets

O-Ring Kit **Black Nitrile K35-2005**

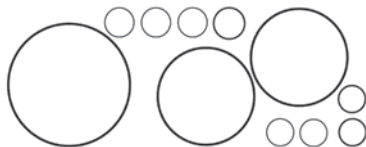

*Includes: Metal Seal Seat O-Ring (1), Internal / Front / Rear Rotor O-Ring (3), Internal Suction O-Ring (2), Center Rotor O-Ring (2), Nose O-Ring (1), Suction / Discharge O-Ring (2)*

O-Ring Kit **K35-6001**

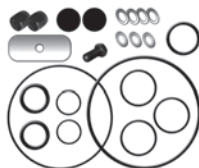

*Includes: Low Side Cap 1/4" Fitting (2), Shipping Pad (2), Shipping Plate (1), Shipping Plate Bolt (1), Head Bolt Washer (4), Clutch Shim (3), Shaft Seal Seat O-Ring (1), Internal Rotor O-Ring (3), Internal Suction O-Ring (2), Center Case O-Ring (1), Nose*

#### Service Items

Fitting (Refrigerant) - 1/8-28 UNF w/Valve/O-Ring **A10-1025**

#### Shaft Seals

Carbon Shaft Seal **HNBR S13-2101**

#### Shaft Seals

Felt Ring **S25-4103**

Lip Seal (Double) **Nitrile S35-1000**

Lip Seal (Triple) **Nitrile S20-1010**

Metal Shaft Seal Seat **S11-3101**

Carbon Shaft Seal Kit **Green HNBR K35-3105**



*Includes: Shaft Seal Retaining Ring (1), Carbon Shaft Seal (1), Metal Shaft Seal Seat (1), Metal Shaft Seal Seat O-Ring (1)*

Lip Seal Kit **Black Nitrile K35-3010**



*Includes: Lip Seal (1), Lip Seal Retaining Ring (1)*

Lip Seal Kit (Late Model) **Green HNBR K20-3130**



*Includes: Lip Seal Retaining Ring (1), Lip Seal (1), Lip Seal O-Ring (1)*

#### Shipping Closures

Cap - 1/4" Low Side **C10-1000**

Shipping Pad (Use with C13-4100 or C13-4101) **C13-3000**

Shipping Plate (Rectangular) (Use with 2 C13-3000) **C13-4100**

## SEIKO-SEIKI

### SS170PSS

#### Shipping Closures

Shipping Plate (Rounded) (Use with 2 C13-3000) **C13-4101**

#### Tools

Shaft Seal Protector, Adjustable **T95-1226**



## TAMA

TM08, TM08HD

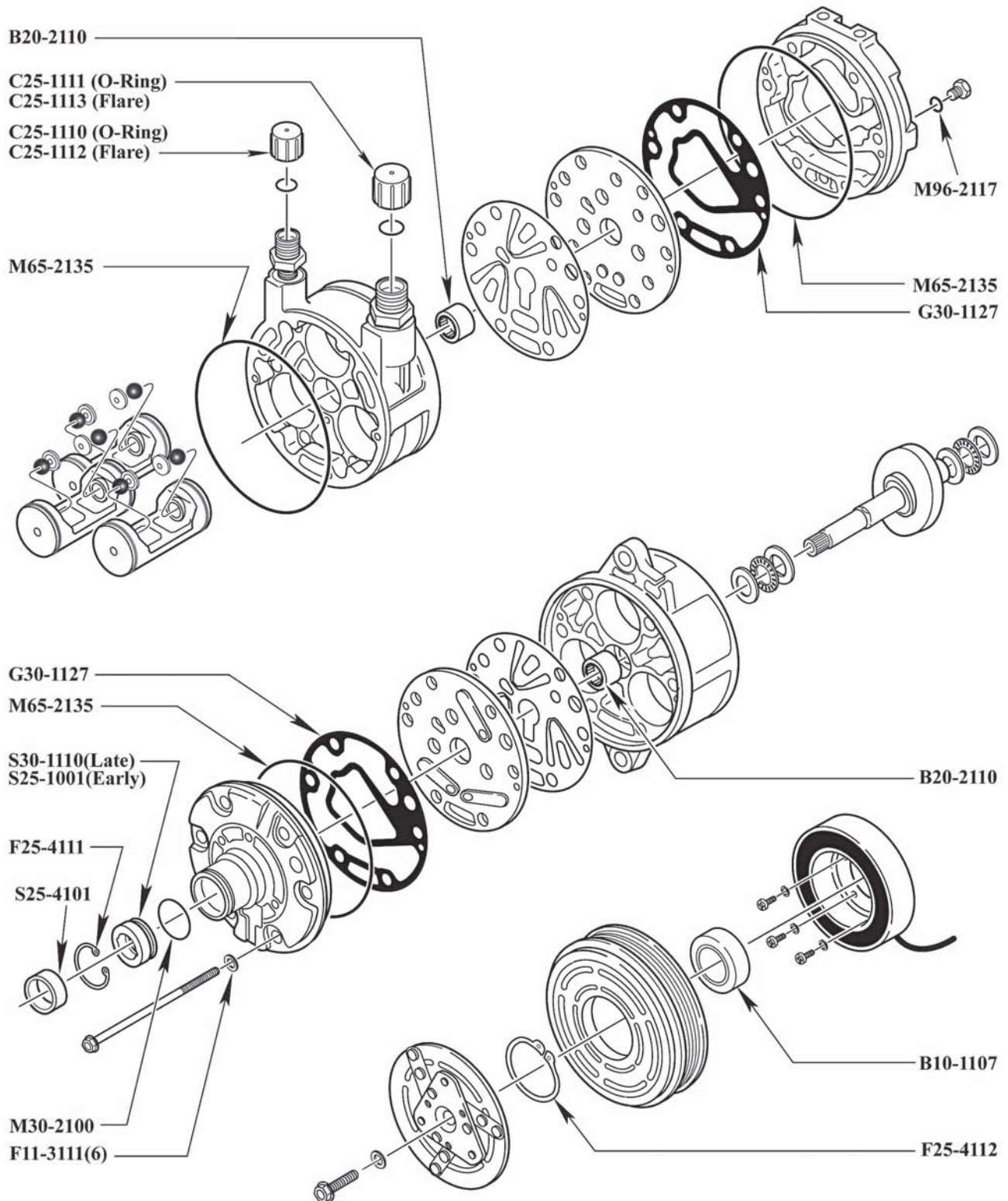

## TAMA

### TM08, TM08HD

O-Rings	R134a and R-12 Compatible	Green HNBR	Black Nitrile
Case O-Ring		<b>M65-2135</b>	<b>M65-1035</b>
Lip Seal O-Ring		<b>M30-2100</b>	<b>M30-1000</b>
Oil Drain Plug O-Ring		<b>M96-2117</b>	

Bearings	
Case Bearing (16mm x 23mm x 16mm)	<b>B20-2110</b>
Clutch Bearing (35mm x 55mm x 20mm)	<b>B10-1107</b>

Chemicals	
Ultra PAG Oil 46 - 6pk, 8 oz Bottle	<b>MT3012</b>
Ultra PAG Oil 46 - 6pk, Quart Bottle	<b>MT3018</b>
Ultra PAG Oil 46 - Drum (52 gal)	<b>A10-6163</b>

Fasteners	
Retaining Ring - Clutch Pulley	<b>F25-4112</b>
Retaining Ring - Lip Seal	<b>F25-4111</b>
Washer - Head Bolt	<b>F11-3111</b>

Gaskets	
Gasket - Head	Fiber <b>G30-1127</b>
Gasket Kit (Fiber)	Green HNBR <b>K30-2123</b>

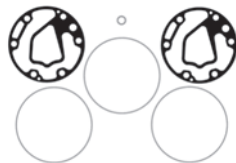

Includes: Head Gasket (2), Case O-Ring (3), Oil Plug O-Ring (1).

Shaft Seals	
Felt Ring	<b>S25-4101</b>
Lip Seal (Metal Can) (Early)	HNBR <b>S25-1001</b>
Lip Seal (Black Rubber Coated)(Late)	HNBR <b>S30-1110</b>
Lip Seal Spacer (Use with S30-1110)	<b>S30-6000</b>
Lip Seal Kit (Black Rubber Coated) (Late)	Green HNBR <b>K30-1110</b>



Includes: Lip Seal Retaining Ring (1), Lip Seal Metal Spacer (1), Lip Seal (1)

Shaft Seals	
Lip Seal Kit (Metal Can)(Early)	Black Nitrile <b>K25-3156</b>



Includes: Lip Seal (1), Lip Seal Felt Ring (1), Lip Seal Retaining Ring (1).

Shipping Closures	
Discharge Cap w/ O-Ring - 4/5" (.800") Height	<b>C25-1112</b>
Discharge Cap w/ O-Ring - 5/8" (.625") Height	<b>C25-1110</b>
Suction Cap w/ Disc - 1" Height	<b>C25-1113</b>
Suction Cap w/ Disc - 7/9" (.701") Height	<b>C25-1111</b>

Tools	
Shaft Seal Protector	<b>T11-1000</b>
Shaft Seal Protector, Adjustable	<b>T95-1228</b>

## TECUMSEH

### HG500

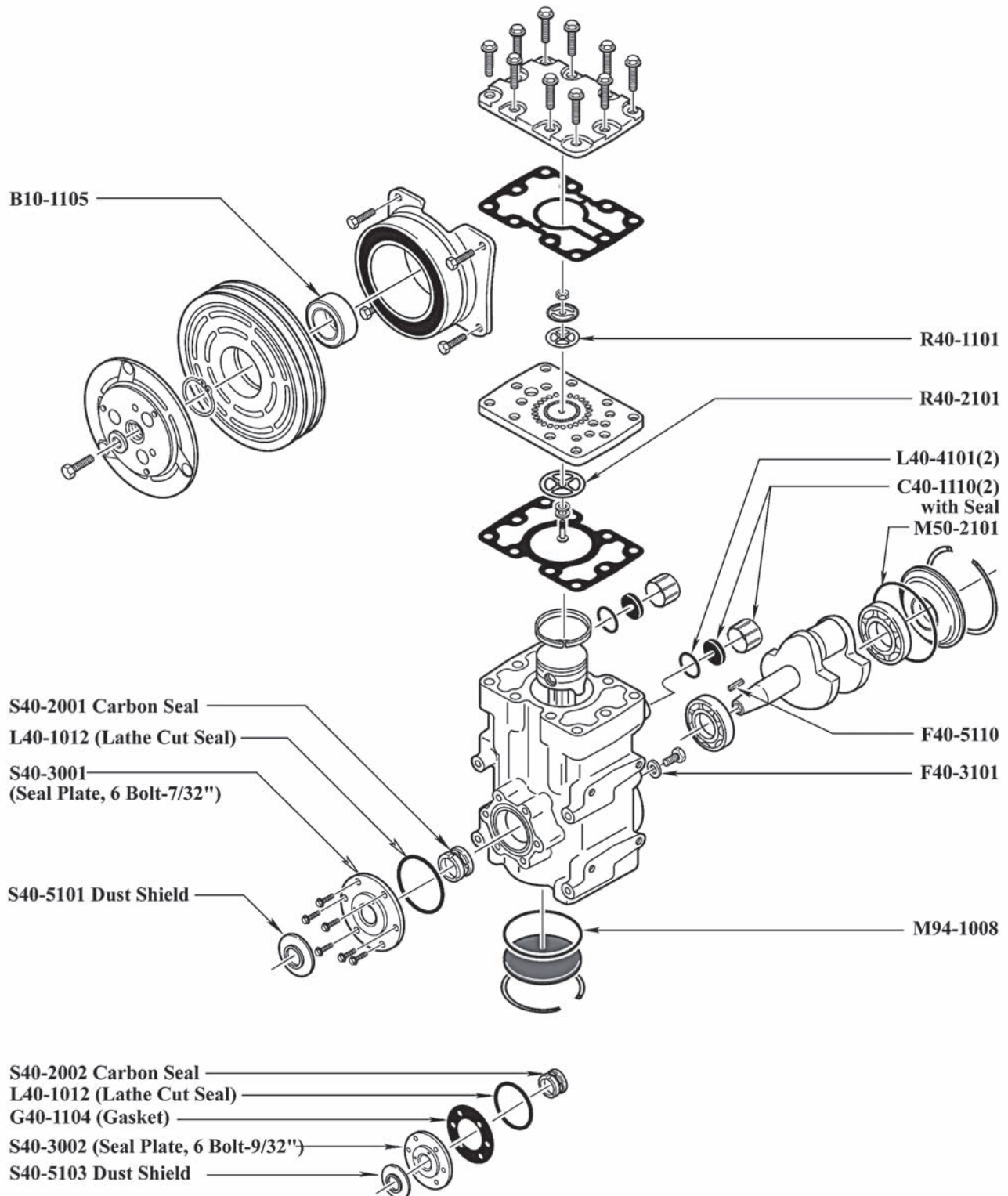

## TECUMSEH

### HG500

O-Rings and Lathe Cuts	R134a and R-12 Compatible	Teflon	Green HNBR	Black Nitrile
Bottom Plate O-Ring				<b>M94-1008</b>
Flange Lathe Cut Seal				<b>L40-1001</b>
Rear Plate O-Ring			<b>M50-2101</b>	<b>M50-1001</b>
Rotolock Service Valve Lathe Cut Seal (White Teflon)		<b>L40-4101</b>		
Shaft Seal Plate Lathe Cut Seal				<b>L40-1012</b>
<b>Bearings</b>				
Clutch Bearing (30mm x 62mm x 16mm-24mm) (Pitts 6", 7")	<b>B10-1105</b>			
<b>Chemicals</b>				
Ultra PAG Oil 46 - 6pk, 8 oz Bottle	<b>MT3012</b>			
Ultra PAG Oil 46 - 6pk, Quart Bottle	<b>MT3018</b>			
Ultra PAG Oil 46 - Drum (52 gal)	<b>A10-6163</b>			
<b>Fasteners</b>				
Shaft Key	<b>F40-5110</b>			
Washer (Copper) - Oil Plug	<b>F40-3101</b>			
<b>Gaskets</b>				
Gasket - Front Seal Plate (use w/ S40-3002)	Fiber	<b>G40-1104</b>		
<b>Reeds and Valve Plates</b>				
Reed - Discharge Valve	<b>R40-2101</b>			
Reed - Suction Valve	<b>R40-1101</b>			
<b>Shaft Seals</b>				
Carbon Shaft Seal (use w/ S40-3001)	Nitrile	<b>S40-2001</b>		
Carbon Shaft Seal (use w/ S40-3002)	Nitrile	<b>S40-2002</b>		
Dust Shield (use w/ S40-3001)		<b>S40-5101</b>		
Dust Shield (use w/ S40-3002)		<b>S40-5103</b>		
Shaft Seal Plate (6 Bolt 7/32" Holes)		<b>S40-3001</b>		
Shaft Seal Plate (6 Bolt 9/32" Holes)		<b>S40-3002</b>		
Carbon Shaft Seal Kit (6 Bolt 7/32" Holes)	Black Nitrile	<b>K40-3015</b>		



Includes: Seal Plate O-Ring (1), Carbon Shaft Seal (1), Shaft Seal Plate (6 Bolt - 7/32" Holes) (1)

#### Shaft Seals

Carbon Shaft Seal Kit (6 Bolt 9/32" Holes) Black Nitrile **K40-3020**



Includes: Seal Plate Gasket - Circular (1), Carbon Shaft Seal (1), Shaft Seal Plate - 6 Bolt -9/32" Holes (1), Dust Shield (1), Plate Lathe Cut Seal (1).

#### Shipping Closures

Shipping Cap - Tube-O Rotolock w/Seal **C40-1110**  
 Shipping Seal (Rotolock / Tube-O) (Use with C40-1110) **C40-3101**

#### Tools

Seal/Plate Alignment Tool **T10-1000**

## TECUMSEH

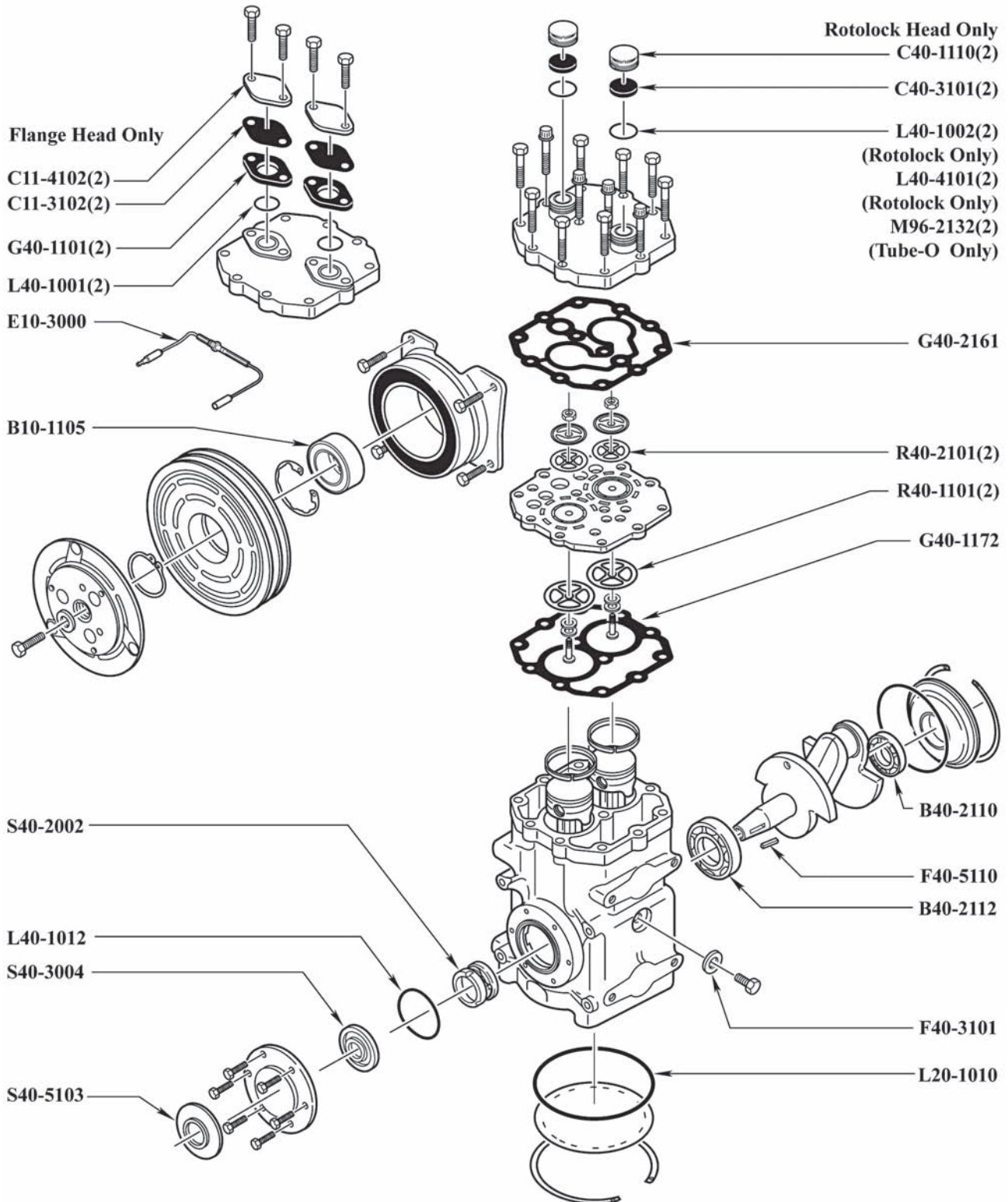

### HG1000, HG850



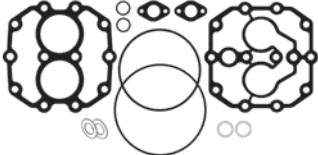

## TECUMSEH

HG1000, HG850

O-Rings and Lathe Cuts	R134a and R-12 Compatible	Teflon	Green HNBR	Black Nitrile
Flange Lathe Cut Seal				<b>L40-1001</b>
Rear Bearing Plate O-Ring				<b>M45-1006</b>
Rotolock Valve Lathe Cut Seal				<b>L40-1002</b>
Rotolock Valve Lathe Cut Seal (White Teflon)		<b>L40-4101</b>		
Shaft Seal Plate Lathe Cut Seal				<b>L40-1012</b>
Tube-O Valve O-Ring			<b>M96-2132</b>	<b>M96-1032</b>
<b>Bearings</b>				
Case Bearing (Front) (30mm x 62mm x 11.3mm)		<b>B40-2112</b>		
Case Bearing (Rear) (17mm x 40mm x 12mm)		<b>B40-2110</b>		
Clutch Bearing (30mm x 62mm x 16mm-24mm) (Pitts 6", 7")		<b>B10-1105</b>		
<b>Chemicals</b>				
Ultra PAG Oil 46 - 6pk, 8 oz Bottle		<b>MT3012</b>		
Ultra PAG Oil 46 - 6pk, Quart Bottle		<b>MT3018</b>		
Ultra PAG Oil 46 - Drum (52 gal)		<b>A10-6163</b>		
<b>Electrical</b>				
Clutch Coil Assembly w/Diode		<b>E10-3000</b>		
<b>Fasteners</b>				
Shaft Key		<b>F40-5110</b>		
Washer (Copper) - Oil Plug		<b>F40-3101</b>		
<b>Gaskets</b>				
Gasket - Cylinder	Fiber	<b>G40-1172</b>		
Gasket - Flange Head Suction / Discharge Port	Fiber	<b>G40-1101</b>		
Gasket - Front Seal Plate (use w/ S40-3002)	Fiber	<b>G40-1104</b>		
Gasket - Head	Metal	<b>G40-2161</b>		
Gasket Kit	Black Nitrile	<b>K40-2010</b>		
				
<p><i>Includes: Oil Plug Washer (Copper) (2), Service Valve Gasket (2), Cylinder Gasket (1), Head Gasket - Metal (1), Base Plate Lathe Cut Seal (1), Rear Bearing Plate Lathe Cut Seal (1), Rotolock Service Valve Seal (Teflon) (2), Tube-O Valve O-Ring (2).</i></p>				
<b>Reeds and Valve Plates</b>				
Reed - Discharge Valve		<b>R40-2101</b>		
Reed - Suction Valve		<b>R40-1101</b>		
<b>Shaft Seals</b>				
Carbon Shaft Seal		Nitrile <b>S40-2002</b>		
Dust Shield		<b>S40-5103</b>		
<b>Shaft Seals</b>				
Shaft Seal Plate (6 Bolt 9/32" Holes)				<b>S40-3002</b>
Shaft Seal Plate (For Large Front Bearing)				<b>S40-3004</b>
Carbon Shaft Seal Kit (6 Bolt 9/32" Holes)			Black Nitrile	<b>K40-3020</b>
				
<p><i>Includes: Seal Plate Gasket - Circular (1), Carbon Shaft Seal (1), Shaft Seal Plate - 6 Bolt -9/32" Holes (1), Dust Shield (1), Plate Lathe Cut Seal (1).</i></p>				
<b>Carbon Shaft Seal Kit (Large Front Bearings)</b>				
			Black Nitrile	<b>K40-3005</b>
				
<p><i>Includes: Plate lathe Cut Seal (1), Carbon Shaft Seal (1), Metal Shaft Seal (1)</i></p>				
<b>Shipping Closures</b>				
Shipping Cap - Long Stem				<b>C40-1101</b>
Shipping Cap - Tube-O Rotolock w/Seal				<b>C40-1110</b>
Shipping Pad (Use with C11-4102)				<b>C11-3102</b>
Shipping Plate (Use with C11-3102)				<b>C11-4102</b>
Shipping Seal (Rotolock / Tube-O) (Use with C40-1110)				<b>C40-3101</b>
<b>Tools</b>				
Seal/Plate Alignment Tool				<b>T10-1000</b>

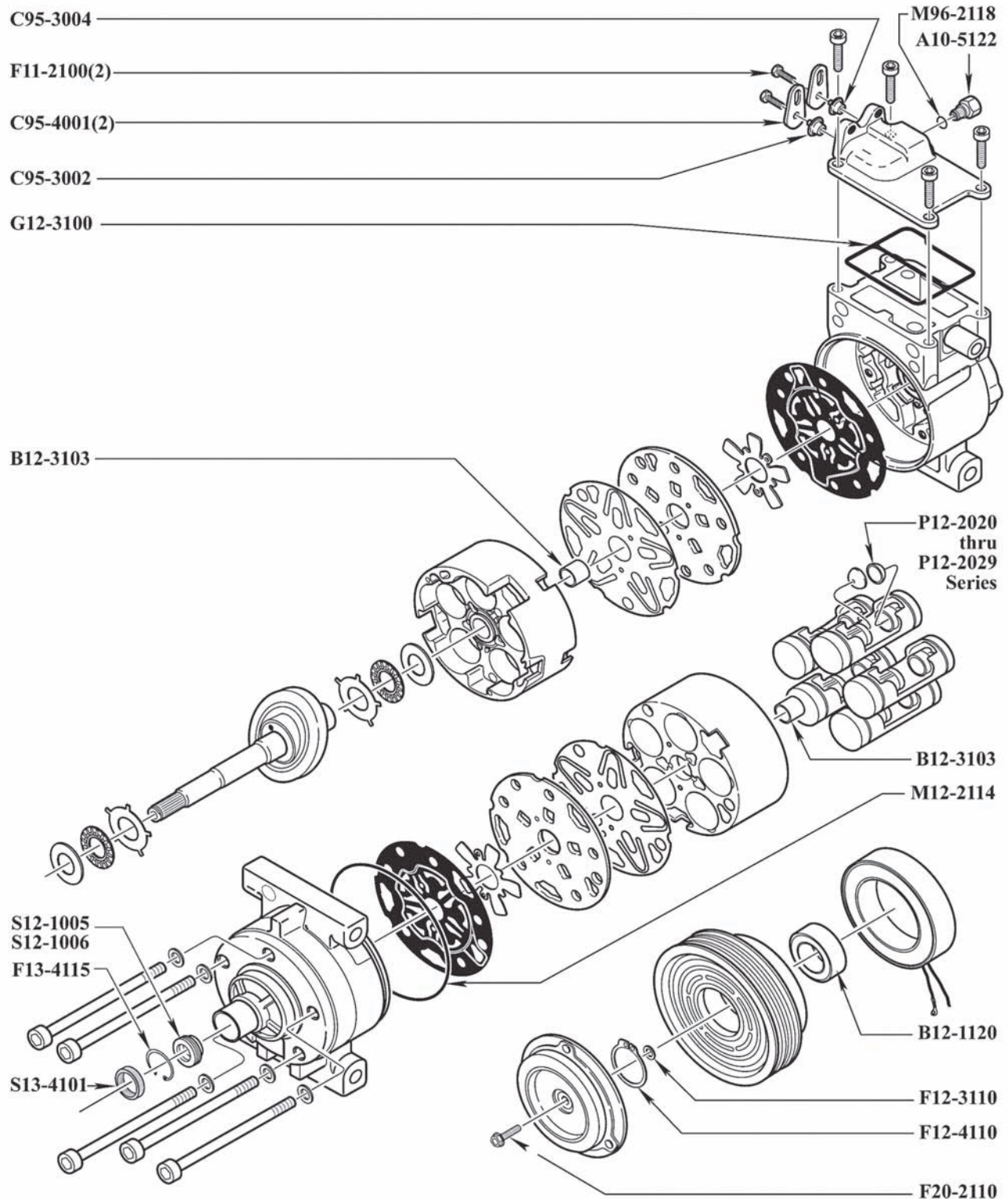

## VISTEON

### HS15



## VISTEON

### HS15

O-Rings	R134a and R-12 Compatible	Green HNBR	Black Nitrile
Case O-Ring		<b>M12-2114</b>	<b>M12-1014</b>
High Pressure Relief Valve O-Ring		<b>M96-2118</b>	<b>M96-1018</b>
<b>Bearings</b>		<b>Piston Components</b>	
Clutch Bearing (30mm x 55mm x 23mm)	<b>B12-1120</b>	Half Ball Shoe (7.530 - 7.535mm)	<b>P12-2028</b>
Shaft Bushing (16.1mm x 18.1mm x 20mm)	<b>B12-3103</b>	Half Ball Shoe (7.535 - 7.540mm)	<b>P12-2029</b>
<b>Chemicals</b>		<b>Service Items</b>	
Ultra PAG Oil 46 - 6pk, 8 oz Bottle	<b>MT3012</b>	High Pressure Relief Valve 3/8-24 w/Non-Captive O-Ring	<b>A10-5122</b>
Ultra PAG Oil 46 - 6pk, Quart Bottle	<b>MT3018</b>	<b>Shaft Seals</b>	
Ultra PAG Oil 46 - Drum (52 gal)	<b>A10-6163</b>	Felt Wiper - Wick Type	<b>S13-4101</b>
<b>Clutch Components</b>		Lip Seal (Black Rubber Coated)	Nitrile <b>S12-1005</b>
Clutch Coil - OD/ID: 101mm / 66mm (Hyundai)	<b>H12-7303</b>	Lip Seal (Black Rubber Coated) (O.E.)	Nitrile <b>S12-1006</b>
Clutch Coil - OD/ID: 101mm / 66mm (Kia)	<b>H12-7304</b>	Lip Seal Kit	Black Nitrile <b>K12-3011</b>
<b>Fasteners</b>			
Bolt - Shaft	<b>F20-2110</b>	<p><i>Includes: Lip Seal Retaining Ring (1), Shaft Bolt (1), Lip Seal (1), Felt Wiper (1), Lip Seal Protector (Plastic-16 Spline) (1).</i></p>	
Bolt - Shipping Plate	<b>F11-2100</b>	<b>Shipping Closures</b>	
Helical Insert - Rear Head / Shipping Plate (8-1.25 x 12mm)	<b>F10-6211</b>	Shipping Plate (Use with C95-3002/C95-3004)	<b>C95-4001</b>
Retaining Ring - Pulley	<b>F12-4110</b>	Shipping Plug (Discharge) (Use with C95-4001)	<b>C95-3002</b>
Retaining Ring - Shaft Seal	<b>F13-4115</b>	Shipping Plug (Suction) (Use with C95-4001)	<b>C95-3004</b>
Shim - Clutch (0.38mm)	<b>F12-3110</b>	<b>Tools</b>	
Clutch Installation Kit	<b>K12-5110</b>	Helical Insert Drill for 8-1.25mm Inserts	<b>T10-6053</b>
		Helical Insert Tap 8-1.25mm	<b>T10-6254</b>
<p><i>Includes: Clutch Shim (0.015" - 0.38mm Thick) (6), Pulley Retaining Ring (1), Shaft Bolt (1)</i></p>		Helical Insert Tool 8-1.25mm - Bolt Style	<b>T10-6554</b>
<b>Gaskets</b>		Lip Seal Protector (16 Spline) (Metal)	<b>T12-1003</b>
Gasket - Suction / Discharge Port	Green HNBR <b>G12-3100</b>	Lip Seal Protector (21 Spline) (Plastic)	<b>T12-1002</b>
HS15 Hyundai Suction / Discharge Manifold	Green HNBR <b>G12-3102</b>	Piston Ring Expansion Cone (Requires T13-3010)	<b>T12-3000</b>
<b>Piston Components</b>		Piston Ring Installer	<b>T13-3010</b>
Half Ball Shoe (7.490 - 7.495mm)	<b>P12-2020</b>	Shaft Seal Protector, Adjustable	<b>T95-1227</b>
Half Ball Shoe (7.495 - 7.500mm)	<b>P12-2021</b>	Shaft Seal Remover	<b>LD99-1326</b>
Half Ball Shoe (7.500 - 7.505mm)	<b>P12-2022</b>		
Half Ball Shoe (7.505 - 7.510mm)	<b>P12-2023</b>		
Half Ball Shoe (7.510 - 7.515mm)	<b>P12-2024</b>		
Half Ball Shoe (7.515 - 7.520mm)	<b>P12-2025</b>		
Half Ball Shoe (7.520 - 7.525mm)	<b>P12-2026</b>		
Half Ball Shoe (7.525 - 7.530mm)	<b>P12-2027</b>		

## VISTEON

### HS17, HS18

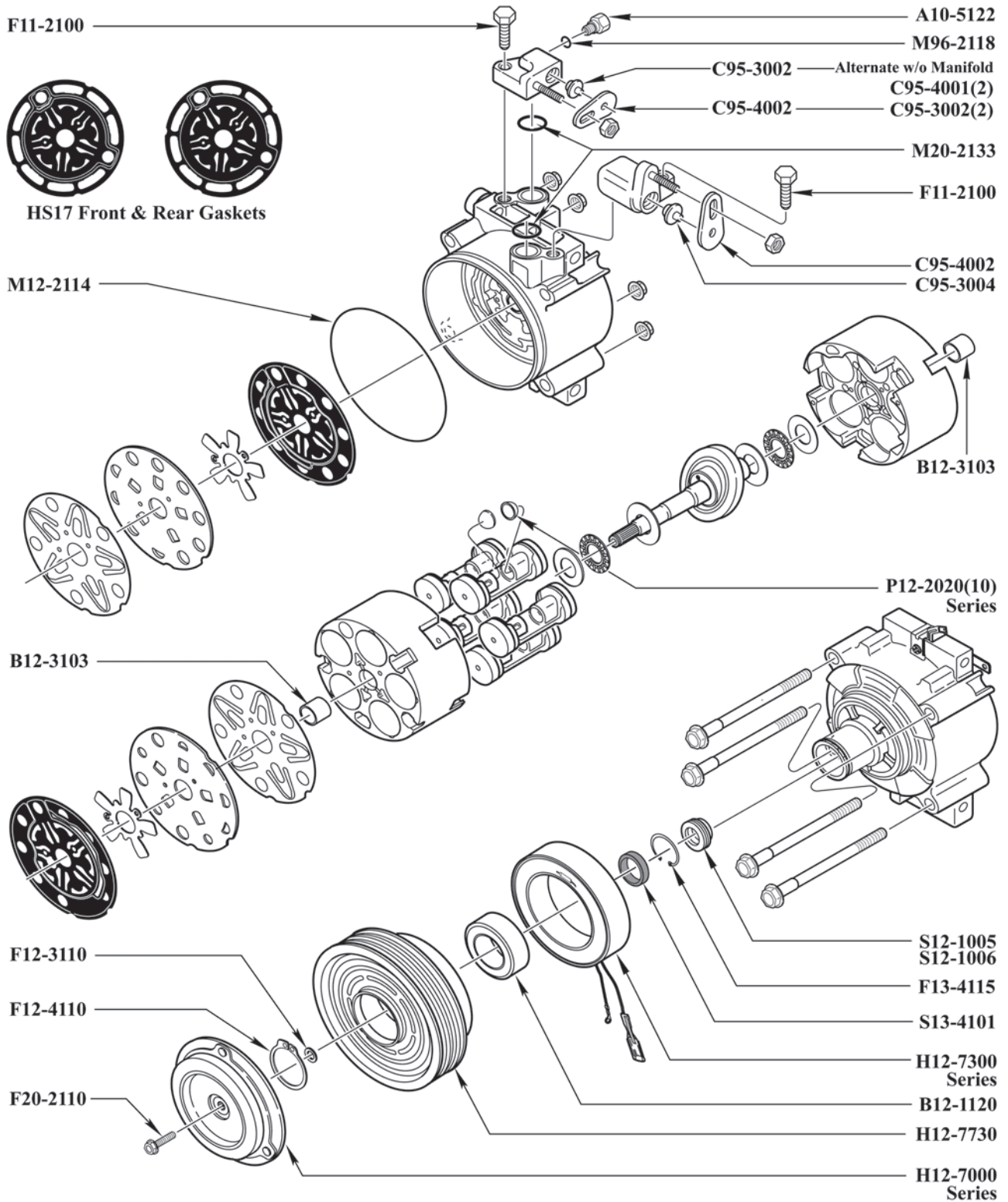

## VISTEON

### HS17, HS18

O-Rings	R134a and R-12 Compatible	Green HNBR	Black Nitrile
Case O-Ring		<b>M12-2114</b>	<b>M12-1014</b>
High Pressure Relief Valve O-Ring		<b>M96-2118</b>	<b>M96-1018</b>
Suction / Discharge Port O-Ring		<b>M20-2133</b>	
<b>Bearings</b>		<b>Piston Components</b>	
Clutch Bearing (30mm x 55mm x 23mm)	<b>B12-1120</b>	Half Ball Shoe (7.515 - 7.520mm)	<b>P12-2025</b>
Shaft Bushing (16.1mm x 18.1mm x 20mm)	<b>B12-3103</b>	Half Ball Shoe (7.520 - 7.525mm)	<b>P12-2026</b>
<b>Chemicals</b>		Half Ball Shoe (7.525 - 7.530mm)	<b>P12-2027</b>
Ultra PAG Oil 46 - 6pk, 8 oz Bottle	<b>MT3012</b>	Half Ball Shoe (7.530 - 7.535mm)	<b>P12-2028</b>
Ultra PAG Oil 46 - 6pk, Quart Bottle	<b>MT3018</b>	Half Ball Shoe (7.535 - 7.540mm)	<b>P12-2029</b>
Ultra PAG Oil 46 - Drum (52 gal)	<b>A10-6163</b>	<b>Service Items</b>	
<b>Clutch Components</b>		High Pressure Relief Valve 3/8-24 w/Non-Captive O-Ring	<b>A10-5122</b>
Clutch Coil - (09-06 Full Size Dodge Pickup)	<b>H12-7309</b>	<b>Shaft Seals</b>	
Clutch Coil - OD/ID: 101mm / 66mm (Hyundai)	<b>H12-7303</b>	Felt Wiper - Wick Type	<b>S13-4101</b>
Clutch Coil - OD/ID: 101mm / 66mm (Kia)	<b>H12-7304</b>	Lip Seal (Black Rubber Coated)	Nitrile <b>S12-1005</b>
Clutch Hub - 3 Grommet (09-06 Full Size Dodge Pickup)	<b>H12-7012</b>	Lip Seal (Black Rubber Coated) (O.E.)	Nitrile <b>S12-1006</b>
Clutch Hub - Total OD: 105mm, Shaft OD: 18mm	<b>H12-7011</b>	Lip Seal Kit	Black Nitrile <b>K12-3011</b>
Clutch Pulley - 8 Groove w/Bearing (Dodge Diesel)	<b>H12-7730</b>		
<b>Fasteners</b>		<p><i>Includes: Lip Seal Retaining Ring (1), Shaft Bolt (1), Lip Seal (1), Felt Wiper (1), Lip Seal Protector (Plastic-16 Spline) (1).</i></p>	
Bolt - Shaft	<b>F20-2110</b>	<b>Shipping Closures</b>	
Bolt - Shipping Plate	<b>F11-2100</b>	Shipping Plate (Use with C95-3002/C95-3004)	<b>C95-4001</b>
Helical Insert - Rear Head / Shipping Plate (8-1.25 x 12mm)	<b>F10-6211</b>	Shipping Plate (Use with C95-3002/C95-3004)	<b>C95-4002</b>
Retaining Ring - Pulley	<b>F12-4110</b>	Shipping Plug (Discharge) (Use with C95-4001/C95-4002)	<b>C95-3002</b>
Retaining Ring - Shaft Seal	<b>F13-4115</b>	Shipping Plug (Suction) (Use with C95-4001/C95-4002)	<b>C95-3004</b>
Shim - Clutch (0.38mm)	<b>F12-3110</b>	<b>Tools</b>	
Clutch Installation Kit	<b>K12-5110</b>	Helical Insert Drill for 8-1.25mm Inserts	<b>T10-6053</b>
		Helical Insert Tap 8-1.25mm	<b>T10-6254</b>
<p><i>Includes: Clutch Shim (0.015" - 0.38mm Thick) (6), Pulley Retaining Ring (1), Shaft Bolt (1)</i></p>		Helical Insert Tool 8-1.25mm - Bolt Style	<b>T10-6554</b>
<b>Piston Components</b>		Lip Seal Protector (16 Spline) (Metal)	<b>T12-1003</b>
Half Ball Shoe (7.490 - 7.495mm)	<b>P12-2020</b>	Lip Seal Protector (21 Spline) (Plastic)	<b>T12-1002</b>
Half Ball Shoe (7.495 - 7.500mm)	<b>P12-2021</b>	Piston Ring Expansion Cone (Requires T13-3010)	<b>T12-3000</b>
Half Ball Shoe (7.500 - 7.505mm)	<b>P12-2022</b>	Piston Ring Installer	<b>T13-3010</b>
Half Ball Shoe (7.505 - 7.510mm)	<b>P12-2023</b>	Shaft Seal Protector, Adjustable	<b>T95-1227</b>
Half Ball Shoe (7.510 - 7.515mm)	<b>P12-2024</b>		

## VISTEON

HS17, HS18

### Tools

Shaft Seal Remover

LD99-1326



## VISTEON

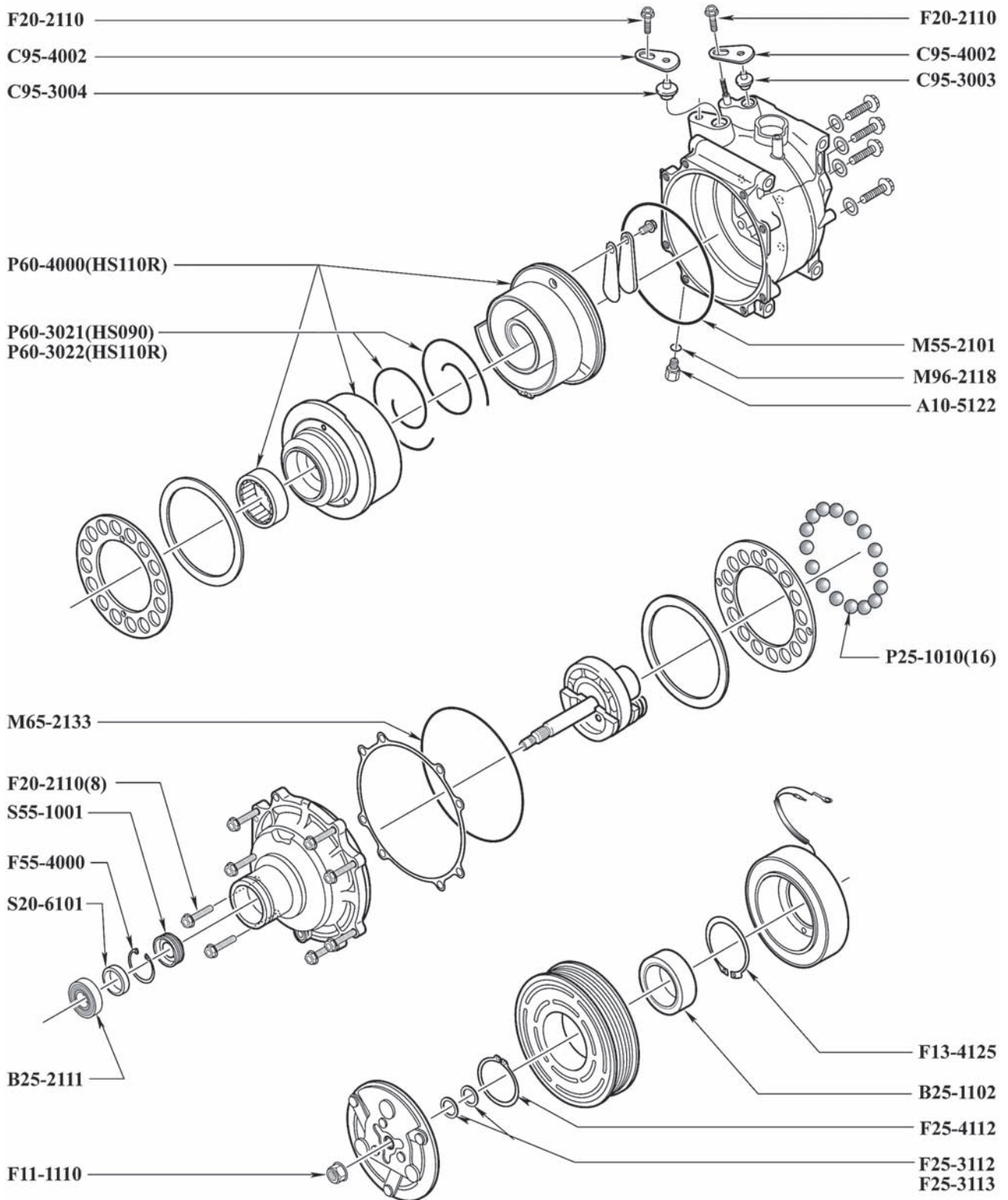

### HS090L, HS090R, HS110R





## VISTEON

### HS090L, HS090R, HS110R

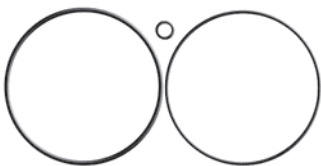
O-Rings	R134a and R-12 Compatible	Green HNBR	Black Nitrile
Case O-Ring - Front		<b>M65-2133</b>	<b>M65-1033</b>
Case O-Ring - Rear		<b>M55-2101</b>	
High Pressure Relief Valve O-Ring (HS090L/R)		<b>M96-2118</b>	<b>M96-1018</b>
Bearings		Shaft Seals	
Nose Bearing (12mm x 28mm x 8mm)	<b>B25-2111</b>	Lip Seal Kit (Rubber Coated Seal)	Black Nitrile <b>K55-3006</b>
Clutch Bearing (35mm x 50mm x 20mm)	<b>B25-1102</b>	 <p><i>Includes: Lip Seal Retaining Ring (1), Lip Seal (1)</i></p>	
Chemicals			
Ultra PAG Oil 46 - 6pk, 8 oz Bottle	<b>MT3012</b>		
Ultra PAG Oil 46 - 6pk, Quart Bottle	<b>MT3018</b>		
Ultra PAG Oil 46 - Drum (52 gal)	<b>A10-6163</b>		
Clutch Components		Shipping Closures	
Clutch Hub - Total OD: 102.3mm	<b>H12-7008</b>	Shipping Plate (Use with C95-3003/3004)	<b>C95-4002</b>
Fasteners		Shipping Plug (Discharge) (Use with C95-4002)	<b>C95-3003</b>
Bolt - Front Head / Shipping Plate	<b>F20-2110</b>	Shipping Plug (Suction) (Use with C95-4002)	<b>C95-3004</b>
Helical Insert - Rear Head / Shipping Plate (8-1.25 x 12mm)	<b>F10-6211</b>	Tools	
Nut - Shaft	<b>F11-1110</b>	Helical Insert Drill for 8-1.25mm Inserts	<b>T10-6053</b>
Retaining Ring - Clutch Coil (Beveled)	<b>F13-4125</b>	Helical Insert Tap 8-1.25mm	<b>T10-6254</b>
Retaining Ring - Clutch Pulley	<b>F25-4112</b>	Helical Insert Tool 8-1.25mm - Bolt Style	<b>T10-6554</b>
Retaining Ring - Lip Seal	<b>F55-4000</b>	Shaft Seal Protector, Adjustable	<b>T95-1225</b>
Shim - Clutch (0.38mm)	<b>F25-3112</b>	Helical Insert Repair Kit (8-1.25mm)	<b>K10-1180</b>
Shim - Clutch (0.76mm)	<b>F25-3113</b>	 <p><i>Includes: Helical Inserts (25), Drill (1), Tap (1), Installation Tool - Bolt Style (1)</i></p>	
Gaskets			
O-Ring Kit	Black Nitrile <b>K14-2000</b>		
 <p><i>Includes: Front Case O-Ring(1), Rear Case O-Ring(1), PRV O-Ring(1)</i></p>			
Rotor Ball (10.31mm) (16/Unit)	<b>P25-1010</b>		
Scroll Rings - Set of 2 (HS090)	<b>P60-3021</b>		
Scroll Rings - Set of 2 (HS110R)	<b>P60-3022</b>		
Scroll Set with Pins and Rings (HS110R)	<b>P60-4000</b>		
Service Items			
High Pressure PRV 3/8-24 w/Non-Captive O-Ring(HS090L/R)	<b>A10-5122</b>		
Shaft Seals			
Felt Wiper (HS090L/R)	<b>S20-6101</b>		
Lip Seal (Black Rubber Coated)	Nitrile <b>S55-1001</b>		

**VISTEON**

**VS12M**

## VISTEON VS12M

O-Rings	R134a and R-12 Compatible	Green HNBR	Black Nitrile
Control Valve Inner O-Ring		<b>M96-2171</b>	
Control Valve Middle O-Ring		<b>M96-2155</b>	
Control Valve Outer O-Ring		<b>M96-2150</b>	

Bearings	
Clutch Bearing (35mm x 52mm x 20mm)	<b>B20-1109</b>

Control valves	
Mechanical Control Valve	<b>A12-5101</b>
O-Ring Kit, Control Valve (3 O-Rings)	Green HNBR <b>K12-2151</b>



Fasteners	
Bolt - Shaft	<b>F20-2110</b>
Retaining Ring - Clutch Coil (Beveled)	<b>F13-4125</b>
Retaining Ring - Clutch Pulley	<b>F25-4112</b>
Retaining Ring - Control Valve	<b>F30-4000</b>
Retaining Ring - Lip Seal	<b>F13-4115</b>
Shim	<b>F20-3000</b>
Shim - Clutch (0.38mm)	<b>F12-3110</b>

Shaft Seals	
Lip Seal (Black Rubber Coated)	Nitrile <b>S12-1005</b>
Lip Seal (Black Rubber Coated) (O.E.)	Nitrile <b>S12-1006</b>

## VISTEON

### VS16

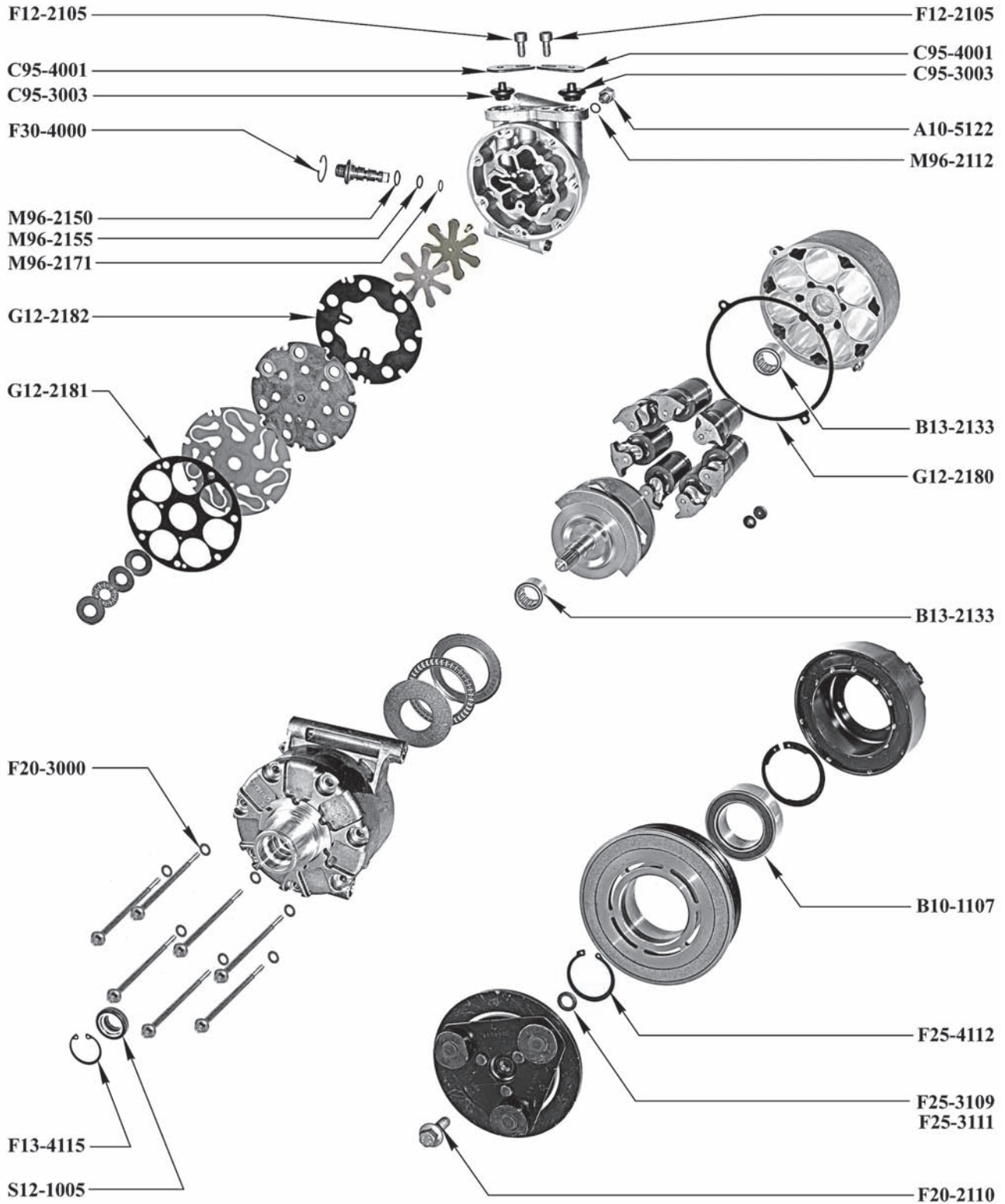

## VISTEON

### VS16

O-Rings	R134a and R-12 Compatible	Green HNBR	Black Nitrile
Control Valve Inner O-Ring		<b>M96-2171</b>	
Control Valve Middle O-Ring		<b>M96-2155</b>	
Control Valve Outer O-Ring		<b>M96-2150</b>	
Pressure Relief Valve O-Ring		<b>M96-2112</b>	
Suction / Discharge Port O-Ring (Optional)		<b>M11-2101</b>	<b>M11-1001</b>

Bearings	
Case Bearing (14.3mm x 20.6mm x 15.7mm)	<b>B13-2133</b>
Clutch Bearing (35mm x 55mm x 20mm)	<b>B10-1107</b>
Control valves	
Mechanical Control Valve	<b>A12-5101</b>
O-Ring Kit, Control Valve (3 O-Rings)	Green HNBR <b>K12-2151</b>



Service Items	
High Pressure Relief Valve 3/8-24 w/Non-Captive O-Ring	<b>A10-5122</b>

Shaft Seals	
Felt Ring	<b>S25-4101</b>
Lip Seal (Black Rubber Coated)	Nitrile <b>S12-1005</b>
Lip Seal (Black Rubber Coated) (O.E.)	Nitrile <b>S12-1006</b>
Lip Seal Kit	Black Nitrile <b>K14-3000</b>



Includes: Lip Seal Retaining Ring (1), Lip Seal (1)

Fasteners	
Bolt - Shaft	<b>F20-2110</b>
Bolt - Shipping Plate	<b>F12-2105</b>
Retaining Ring - Clutch Pulley	<b>F25-4112</b>
Retaining Ring - Contol Valve	<b>F30-4000</b>
Retaining Ring - Lip Seal	<b>F13-4115</b>
Washer - Head Bolt	<b>F20-3000</b>
Shim - Clutch (0.38mm)	<b>F25-3111</b>
Shim - Clutch (0.76mm)	<b>F25-3109</b>

Gaskets	
Visteon VS16 Cylinder Gasket (Metal)	Metal <b>G12-2181</b>
Visteon VS16 Front Head Gasket (Metal)	Metal <b>G12-2180</b>
Visteon VS16 Rear Head Gasket (Metal)	Metal <b>G12-2182</b>
Visteon VS16 Metal Gasket Kit	Green HNBR <b>K12-2152</b>

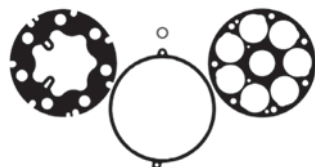

Includes: Front Head Gasket(1), Cylinder Gasket(1), Rear Head Gasket(1), PRV O-Ring(1)

Shipping Closures	
Shipping Pad (Use with C11-4103)	<b>C11-3103</b>
Shipping Plate (Use with C11-3103)	<b>C11-4103</b>
Shipping Plate (Use with C95-3003)	<b>C95-4001</b>
Shipping Plug (Suction/Disch) (Use with C95-4001)	<b>C95-3003</b>

Tools	
Shaft Seal Protector, Adjustable	<b>T95-1227</b>





## VISTEON VS18, VS18M

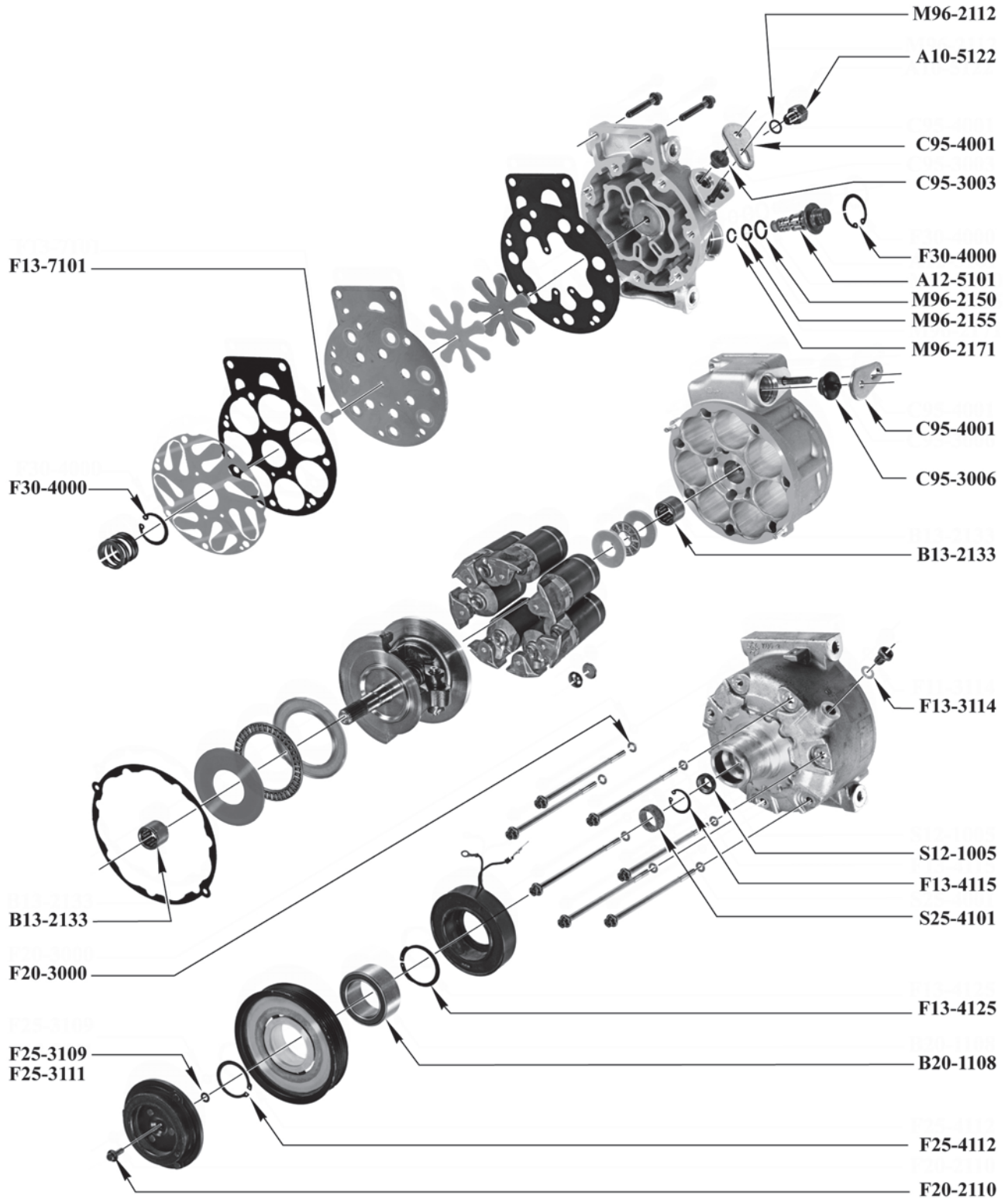



## VISTEON

### VS18, VS18M

O-Rings	R134a and R-12 Compatible	Green HNBR	Black Nitrile
Control Valve Inner O-Ring		<b>M96-2171</b>	
Control Valve Middle O-Ring		<b>M96-2155</b>	
Control Valve Outer O-Ring		<b>M96-2150</b>	
Pressure Relief Valve O-Ring		<b>M96-2112</b>	

Bearings	
Case Bearing (14.3mm x 20.6mm x 15.7mm)	<b>B13-2133</b>
Clutch Bearing (35mm x 52mm x 22mm)	<b>B20-1108</b>

Chemicals	
Ultra PAG Oil 46 - 6pk, 8 oz Bottle	<b>MT3012</b>
Ultra PAG Oil 46 - 6pk, Quart Bottle	<b>MT3018</b>
Ultra PAG Oil 46 - Drum (52 gal)	<b>A10-6163</b>

Clutch Components	
Clutch Coil (with Thermal Fuse) - OD/ID:100mm / 60mm	<b>H12-7308E</b>

Control valves	
Mechanical Control Valve	<b>A12-5101</b>
O-Ring Kit, Control Valve (3 O-Rings)	Green HNBR <b>K12-2151</b>



Fasteners	
Bolt - Shaft	<b>F20-2110</b>
Rivet - Discharge Valve	<b>F13-7101</b>
Retaining Ring - Clutch Coil (Beveled)	<b>F13-4125</b>
Retaining Ring - Clutch Pulley	<b>F25-4112</b>
Retaining Ring - Control Valve and Shaft Spring	<b>F30-4000</b>
Retaining Ring - Lip Seal	<b>F13-4115</b>
Washer - Head Bolt	<b>F20-3000</b>
Shim - Clutch (0.38mm)	<b>F25-3111</b>
Shim - Clutch (0.76mm)	<b>F25-3109</b>
Washer - Oil Drain Bolt	<b>F13-3114</b>

Service Items	
High Pressure Relief Valve 3/8-24 w/Non-Captive O-Ring	<b>A10-5122</b>

Shaft Seals	
Felt Ring	<b>S25-4101</b>
Lip Seal (Black Rubber Coated)	Nitrile <b>S12-1005</b>

Shaft Seals	
Lip Seal (Black Rubber Coated) (O.E.)	Nitrile <b>S12-1006</b>
Lip Seal Kit	Black Nitrile <b>K14-3000</b>



Includes: Lip Seal Retaining Ring (1), Lip Seal (1)

Shipping Closures	
Shipping Plate (Use with C95-3003 and C95-3006)	<b>C95-4001</b>
Shipping Plug (Discharge) (Use with C95-4001)	<b>C95-3003</b>
Shipping Plug (Suction) (Use with C95-4001)	<b>C95-3006</b>

Tools	
Shaft Seal Protector, Adjustable	<b>T95-1227</b>

## YORK

206, 209, 210

### Shaft Detail Indicating Compressor Displacement

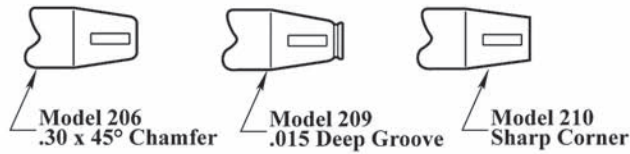

### FLANGE HEAD

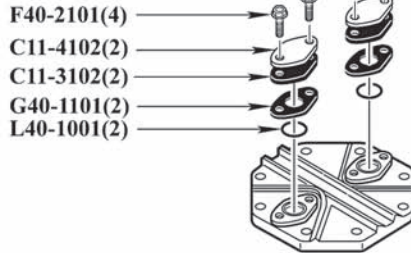

B10-1105

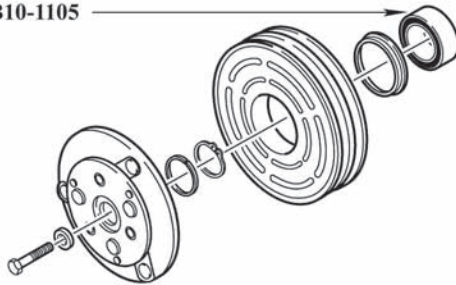

S40-2001 Carbon Seal

L40-1012 (Lathe Cut Seal)

S40-3001 (Seal Plate, 6 Bolt-7/32")

S40-5101 Dust Shield

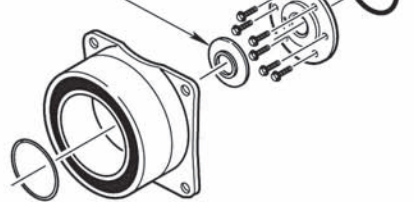

S40-2002 Carbon Seal

L40-1012 (Lathe Cut Seal)

G40-1104 (Gasket)

S40-3002 (Seal Plate, 6 Bolt-9/32")

S40-5103 Dust Shield

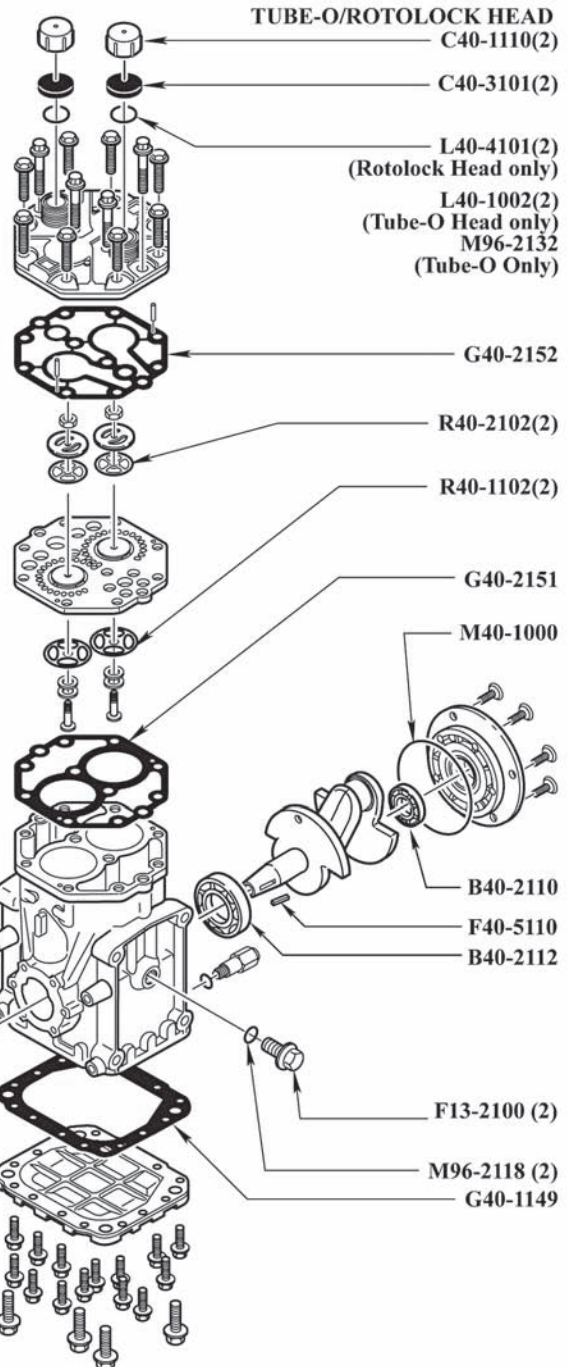
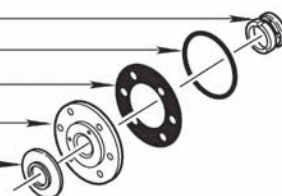

S40-2001 Carbon Seal

M65-1025

S40-3003 (Seal Plate, 5 Bolt)

S40-5101 Dust Shield

## YORK

206, 209, 210

O-Rings and Lathe Cuts	R134a and R-12 Compatible	Teflon	Green HNBR	Black Nitrile
Flange Lathe Cut Seal				<b>L40-1001</b>
Oil Drain Plug O-Ring			<b>M96-2118</b>	<b>M96-1018</b>
Rear Bearing Plate O-Ring				<b>M40-1000</b>
Rotolock Valve Lathe Cut Seal				<b>L40-1002</b>
Rotolock Valve Lathe Cut Seal (White Teflon)		<b>L40-4101</b>		
Shaft Seal Plate Lathe Cut Seal (use w/ 6 Bolt Plates)				<b>L40-1012</b>
Shaft Seal Plate O-Ring (use w/ S40-3003)				<b>M65-1025</b>
Tube-O Valve / Rotolock Adapter O-Ring			<b>M96-2132</b>	<b>M96-1032</b>

Bearings	
Case Bearing (Front) (30mm x 62mm x 11.3mm)	<b>B40-2112</b>
Case Bearing (Rear) (17mm x 40mm x 12mm)	<b>B40-2110</b>
Clutch Bearing (30mm x 62mm x 16mm-24mm) (Pitts 6", 7")	<b>B10-1105</b>

Chemicals	
Ultra PAG Oil 46 - 6pk, 8 oz Bottle	<b>MT3012</b>
Ultra PAG Oil 46 - 6pk, Quart Bottle	<b>MT3018</b>
Ultra PAG Oil 46 - Drum (52 gal)	<b>A10-6163</b>

Clutch Components	
Clutch Assembly - 2 Groove, Single Wire	<b>H40-7901</b>

Fasteners	
Bolt - Oil Plug	<b>F13-2100</b>
Bolt - Shipping Plate (for Flat Top Models)	<b>F40-2101</b>
Shaft Key	<b>F40-5110</b>

Gaskets	
Gasket - Base Plate	Fiber <b>G40-1149</b>
Gasket - Flange Head Suction / Discharge Port	Fiber <b>G40-1101</b>
Gasket - Front Seal Plate (use w/ S40-3002)	Fiber <b>G40-1104</b>
Gasket - Cylinder	Metal <b>G40-2151</b>
Gasket - Head	Metal <b>G40-2152</b>
Gasket Kit	Black Nitrile <b>K40-2021</b>

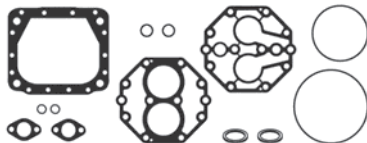

*Includes: Gaskets: Service Valve(2), Base Plate(1), Cylinder-Metal (1), Head-Metal (1); Seal Plate Lathe Cut Seal (5 Bolt)(1); Rotolock Service Valve/Adapter Seal (Teflon)(2); O-Rings: Oil Plug(2), Tube O Valve/Rotolock Adapter(2), Rear Bearing Plate(1).*

### Reeds and Valve Plates

Reed - Suction Valve	<b>R40-1102</b>
----------------------	-----------------

### Shaft Seals

Carbon Shaft Seal (use w/ S40-3001 or S40-3003)	Nitrile <b>S40-2001</b>
Carbon Shaft Seal (use w/ S40-3002)	Nitrile <b>S40-2002</b>
Dust Shield (use w/ S40-3001 or S40-3003)	<b>S40-5101</b>
Dust Shield (use w/ S40-3002)	<b>S40-5103</b>
Shaft Seal Plate (5 Bolt 9/32" Holes)	<b>S40-3003</b>
Shaft Seal Plate (6 Bolt 7/32" Holes)	<b>S40-3001</b>
Shaft Seal Plate (6 Bolt 9/32" Holes)	<b>S40-3002</b>
Carbon Shaft Seal Kit (5 Bolt 9/32" Holes)	Black Nitrile <b>K40-3025</b>



*Includes: Seal Plate Lathe Cut Seal (1), Carbon Shaft Seal (1), Shaft Seal Plate (5 Bolt - 9/32" Holes) (1).*

Carbon Shaft Seal Kit (6 Bolt 7/32" Holes)	Black Nitrile <b>K40-3015</b>
--	-------------------------------



*Includes: Seal Plate O-Ring (1), Carbon Shaft Seal (1), Shaft Seal Plate (6 Bolt - 7/32" Holes) (1)*

### Reeds and Valve Plates

Reed - Discharge Valve	<b>R40-2102</b>
------------------------	-----------------

## YORK

206, 209, 210

### Shaft Seals

Carbon Shaft Seal Kit (6 Bolt      Black Nitrile **K40-3020**  
9/32" Holes)



*Includes: Seal Plate Gasket - Circular (1), Carbon Shaft Seal (1), Shaft Seal Plate - 6 Bolt -9/32" Holes (1), Dust Shield (1), Plate Lathe Cut Seal (1).*

### Shipping Closures

Shipping Cap - Long Stem	<b>C40-1101</b>
Shipping Cap - Tube-O Rotolock w/Seal	<b>C40-1110</b>
Shipping Pad (Use with C11-4102)	<b>C11-3102</b>
Shipping Plate (Use with C11-3102)	<b>C11-4102</b>
Shipping Seal (Rotolock / Tube-O) (Use with C40-1110)	<b>C40-3101</b>

### Tools

Seal/Plate Alignment Tool	<b>T10-1000</b>
---------------------------	-----------------



## YORK SC206, SC209

### Shaft Detail Indicating Compressor Displacement



F40-2101(2)

C11-4103(2)

C11-3103(2)

FLANGE HEAD

C40-1110(2)

L40-1002(2)  
(Tubo Valve only)

L40-4101(2)  
(Rotolock Head only)

TUBE-O/ROTOLOCK HEAD

M96-2118

F40-5110

S40-2001

L40-1012

S40-3001

S40-5103

E10-3000

G40-2171

R40-2102(2)

R40-1102(2)

G40-1160

M40-1000

F40-5110

M96-2118

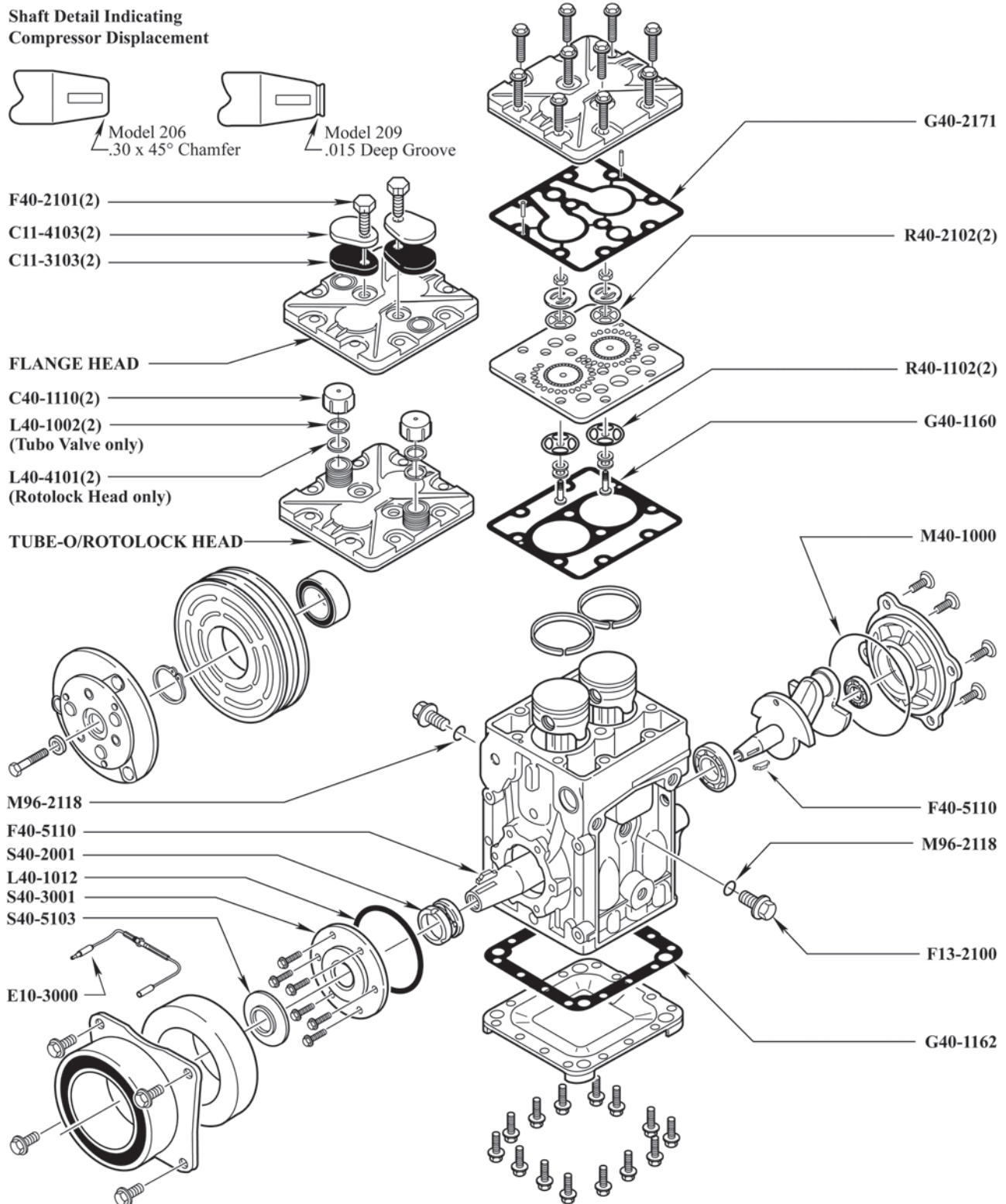

F13-2100

G40-1162

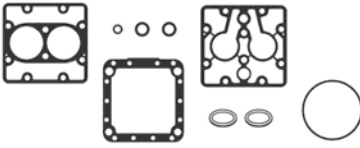

## YORK

### SC206, SC209

O-Rings and Lathe Cuts	R134a and R-12 Compatible	Teflon	Green HNBR	Black Nitrile
Oil Drain Plug O-Ring			<b>M96-2118</b>	<b>M96-1018</b>
Rear Bearing Plate O-Ring				<b>M40-1000</b>
Rotolock Valve Lathe Cut Seal				<b>L40-1002</b>
Rotolock Valve Lathe Cut Seal (White Teflon)		<b>L40-4101</b>		
Shaft Seal Plate Lathe Cut Seal				<b>L40-1012</b>
<b>Chemicals</b>				
Ultra PAG Oil 46 - 6pk, 8 oz Bottle	<b>MT3012</b>			
Ultra PAG Oil 46 - 6pk, Quart Bottle	<b>MT3018</b>			
Ultra PAG Oil 46 - Drum (52 gal)	<b>A10-6163</b>			
<b>Electrical</b>				
Clutch Coil Assembly w/Diode	<b>E10-3000</b>			
<b>Fasteners</b>				
Bolt - Oil Plug	<b>F13-2100</b>			
Bolt - Shipping Plate (for Flat Top Models)	<b>F40-2101</b>			
Shaft Key	<b>F40-5110</b>			
<b>Gaskets</b>				
Gasket - Base Plate	Fiber <b>G40-1162</b>			
Gasket - Cylinder	Fiber <b>G40-1160</b>			
Gasket - Head	Metal <b>G40-2171</b>			
Gasket Kit	Black Nitrile <b>K40-2015</b>			
				
<p><i>Includes: Cylinder Gasket (1), Base Plate Gasket (1), Head Gasket - Metal (1), Tube-O Valve Lathe Cut Seal (2), Rotolock Service Valve Seal (Teflon) (2), Oil Plug O-Ring (1), Rear Bearing Plate O-Ring (1).</i></p>				
<b>Reeds and Valve Plates</b>				
Reed - Discharge Valve	<b>R40-2102</b>			
Reed - Suction Valve	<b>R40-1102</b>			
<b>Shaft Seals</b>				
Carbon Shaft Seal	Nitrile <b>S40-2001</b>			
Dust Shield	<b>S40-5101</b>			
Dust Shield	<b>S40-5103</b>			
Shaft Seal Plate (6 Bolt 7/32" Holes)	<b>S40-3001</b>			
<b>Shaft Seals</b>				
Carbon Shaft Seal Kit (6 Bolt 7/32" Holes)			Black Nitrile <b>K40-3015</b>	
				
<p><i>Includes: Seal Plate O-Ring (1), Carbon Shaft Seal (1), Shaft Seal Plate (6 Bolt - 7/32" Holes) (1)</i></p>				
<b>Shipping Closures</b>				
Shipping Cap - Tube-O Rotolock w/Seal	<b>C40-1110</b>			
Shipping Pad (Use with C11-4103)	<b>C11-3103</b>			
Shipping Plate (Use with C11-3103)	<b>C11-4103</b>			
Shipping Seal (Rotolock / Tube-O) (Use with C40-1110)	<b>C40-3101</b>			
Shipping Plate (Use with C95-3006)	<b>C95-4001</b>			
Shipping Plug (Suction/Disch) (Use with C95-4001)	<b>C95-3006</b>			
<b>Tools</b>				
Seal/Plate Alignment Tool	<b>T10-1000</b>			

## ZEXEL

### DCS17, DCS17E, DCS17EC

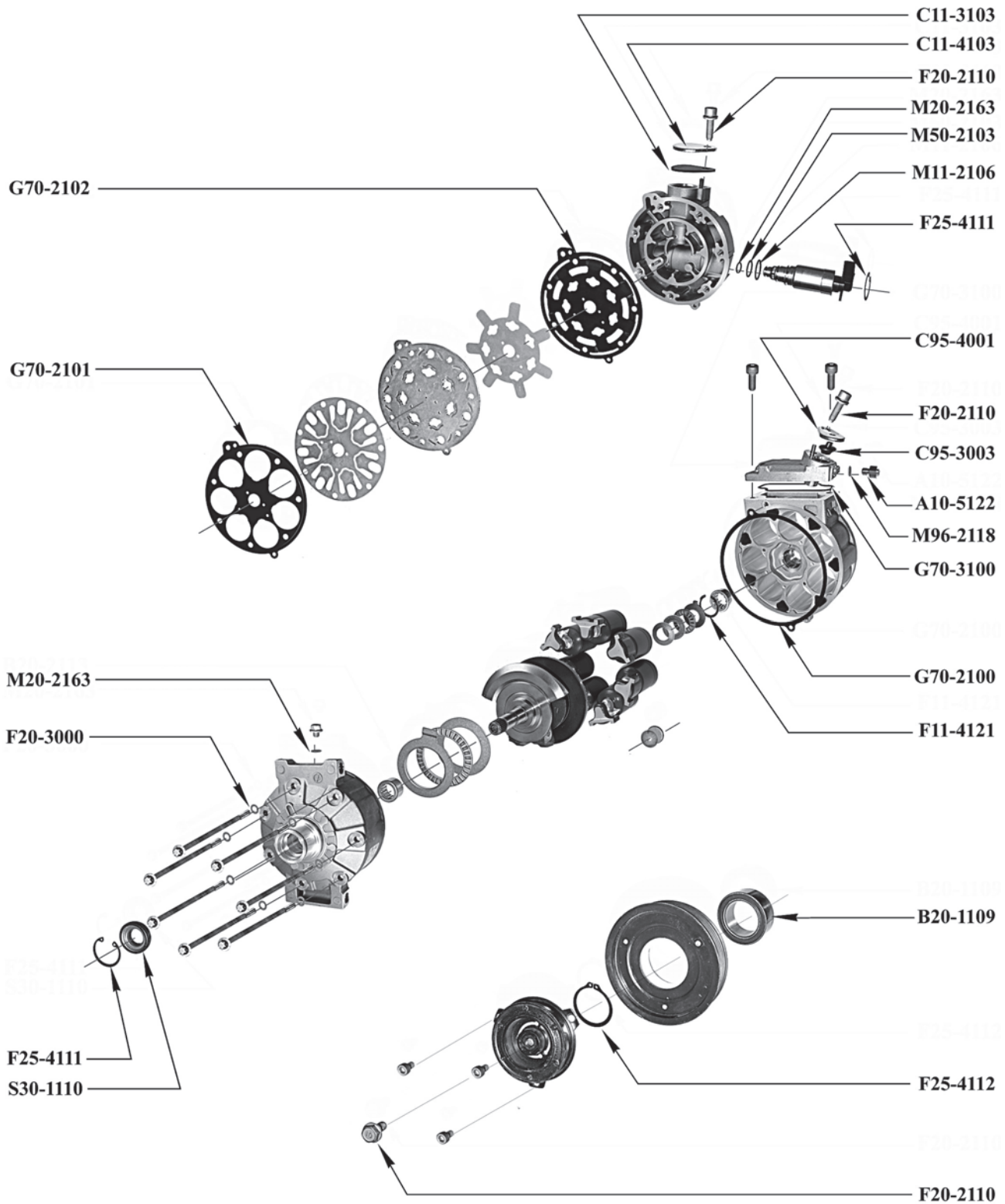



## ZEXEL

### DCS17, DCS17E, DCS17EC

O-Rings	R134a and R-12 Compatible	Green HNBR	Black Nitrile
Control Valve Middle O-Ring		<b>M50-2103</b>	<b>M50-1003</b>
Control Valve O-Ring (Inner)/Oil Drain Plug		<b>M20-2163</b>	
Control Valve O-Ring (Outer)		<b>M11-2106</b>	<b>M11-1006</b>
High Pressure Relief Valve O-Ring		<b>M96-2118</b>	<b>M96-1018</b>

Bearings	
Clutch Bearing (35mm x 52mm x 20mm)	<b>B20-1109</b>
Clutch Bearing (35mm x 55mm x 22mm)	<b>B70-1101</b>

Chemicals	
Ultra PAG Oil 46 - 6pk, 8 oz Bottle	<b>MT3012</b>
Ultra PAG Oil 46 - 6pk, Quart Bottle	<b>MT3018</b>
Ultra PAG Oil 46 - Drum (52 gal)	<b>A10-6163</b>

Control Valves	
Control Valve (90 degree connector)	<b>E70-7000</b>
Control Valve (extended connector)	<b>E70-7000</b>
O-Ring Kit, Control Valve (3 O-Rings)	Green HNBR <b>K70-2102</b>



Fasteners	
Bolt - Shipping Plate / Shaft	<b>F20-2110</b>
Helical Insert - Manifold / Shipping Plate (8-1.25 x 12mm)	<b>F10-6211</b>
Retaining Ring - Clutch Pulley	<b>F25-4112</b>
Retaining Ring - Lip Seal / Control Valve	<b>F25-4111</b>
Retaining Ring - Rear Case Bearing	<b>F11-4121</b>
Washer - Head Bolt	<b>F20-3000</b>

Gaskets	
Gasket - Cylinder (Metal)	Metal <b>G70-2101</b>
Gasket - Front Head (Metal)	Metal <b>G70-2100</b>
Gasket - Rear Head (Metal)	Metal <b>G70-2102</b>
Gasket - Discharge Port	Green HNBR <b>G70-3100</b>

### Gaskets

Gasket Kit (Metal) Green HNBR **K70-2101**



Includes: Gaskets: Front Head Gasket(1), Cylinder Gasket(1), Rear Head Gasket(1), Discharge Port Molded Shape(1), Oil Drain Plug O-Ring(1), and PRV O-Ring(1).

### Service Items

High Pressure Relief Valve 3/8-24 w/Non-Captive O-Ring **A10-5122**

### Shaft Seals

Lip Seal (Black Rubber Coated) HNBR **S30-1110**

Lip Seal Kit Green HNBR **K30-1110**



Includes: Lip Seal Retaining Ring (1), Lip Seal Metal Spacer (1), Lip Seal (1)

### Shipping Closures

Shipping Pad (Use with C11-4103) **C11-3103**

Shipping Plate (Use with C11-3103) **C11-4103**

Shipping Plate (Use with C95-3003) **C95-4001**

Shipping Plug (Discharge) (Use with C95-4001) **C95-3003**

### Tools

Helical Insert Drill for 8-1.25mm Inserts **T10-6053**

Helical Insert Tap 8-1.25mm **T10-6254**

Helical Insert Tool 8-1.25mm - Bolt Style **T10-6554**

Shaft Seal Protector, Adjustable **T95-1227**

## ZEXEL DCS171C

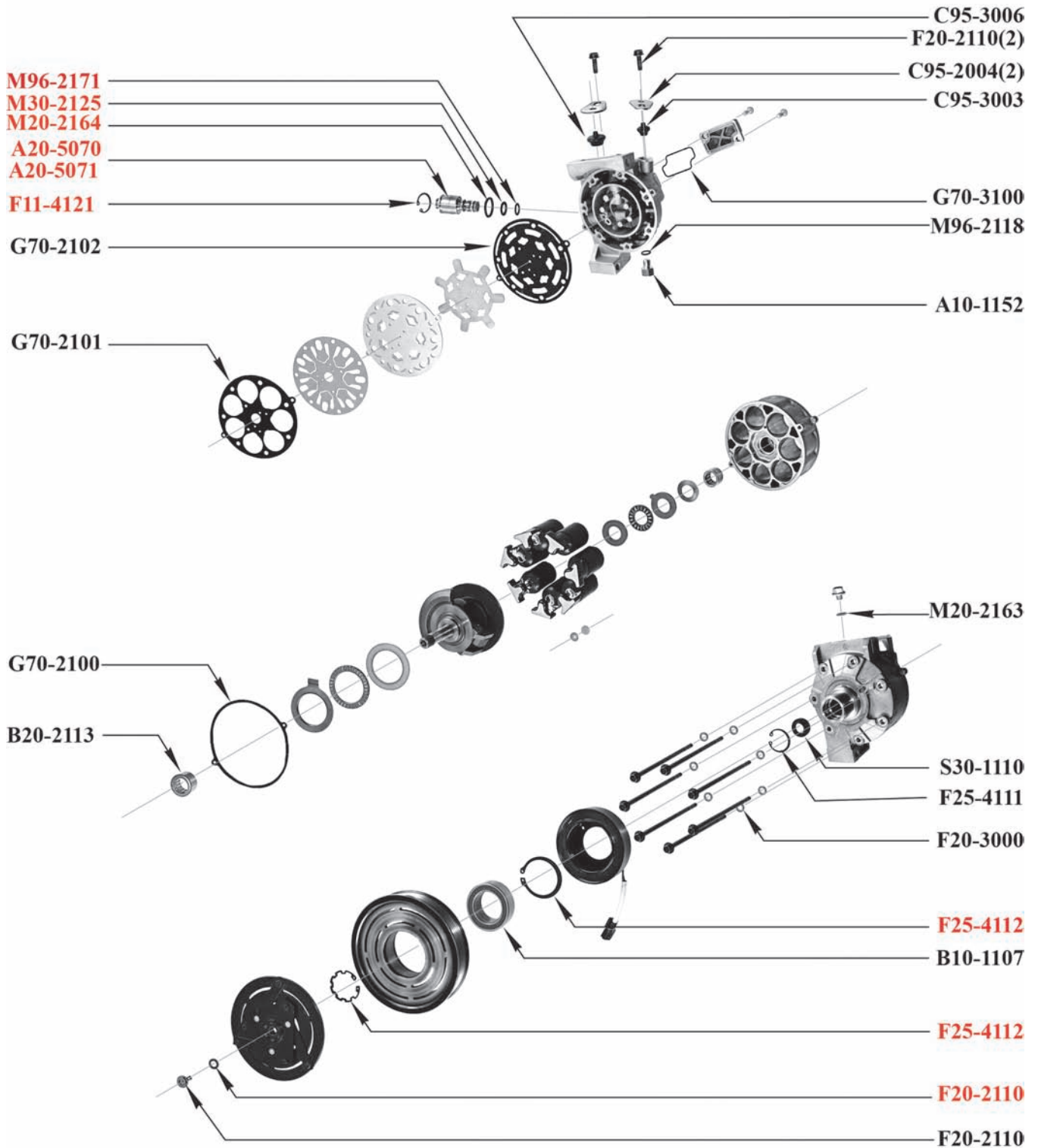

## ZEXEL

### DCS171C

O-Rings	R134a and R-12 Compatible	Green HNBR	Black Nitrile
Control Valve Inner O-Ring		<b>M96-2171</b>	
Control Valve Middle O-Ring		<b>M96-2155</b>	
Control Valve Outer O-Ring		<b>M20-2164</b>	
High Pressure Relief Valve O-Ring		<b>M96-2118</b>	<b>M96-1018</b>
Oil Drain Bolt O-Ring		<b>M20-2163</b>	

#### Bearings

Clutch Bearing (35mm x 55mm x 20mm) **B10-1107**

#### Control Valves

Main Control Valve **A20-5070**

Main Control Valve, Late **A20-5071**

O-Ring Kit, Control Valve Green HNBR **K20-2176**



#### Fasteners

Bolt - Shipping Plate / Shaft **F20-2110**

Retaining Ring - Clutch Coil (Beveled) **F13-4125**

Retaining Ring - Clutch Pulley **F25-4112**

Retaining Ring - Control Valve **F11-4121**

Retaining Ring - Lip Seal **F25-4111**

Washer - Head Bolt **F20-3000**

#### Gaskets

Gasket - Cylinder (Metal) Metal **G70-2101**

Gasket - Front Head (Metal) Metal **G70-2100**

Gasket - Rear Head (Metal) Metal **G70-2102**

Gasket - Discharge Housing Green HNBR **G70-3100**

#### Shaft Seals

Lip Seal (Black Rubber Coated) HNBR **S30-1110**

#### Shipping Closures

Shipping Plug (Discharge) (Use with C95-4004) **C95-3003**

Shipping Plug (Suction) (Use with C95-4004) **C95-3006**















## Terms and Conditions

### TERMS:

Open Account Customers: ..... \$45.00 Minimum Order, \$15.00 Minimum Line.

C.O.D. Customers: ..... \$45.00 Minimum Order, \$15.00 Minimum Line.

..... Cash In Advance required for Special Order, non-stock items.

Cash In Advance Customers: ..... \$250.00 Minimum Order, \$15.00 Minimum Line New.

Customers: ..... \$2,500.00 Minimum Initial Order, \$10,000.00 Minimum per Year.

### SHIPPING METHOD:

If no preferred method is stated for shipment, every effort will be made to ship by the most economical method possible. Exceptional care is taken to insure safe transit of all Santech® products, receipt of which, by the designated transportation company, ends Santech's responsibility. Customers are requested to carefully inspect arriving shipments and should refuse or accept damaged products only after a damage notation is made on the freight bill in writing. Claims for delay, loss or damage should be made against

### RETURN POLICY:

The purpose of this policy is to have clear and executable guidelines to effectively authorize a credit when a Santech product purchased is unsatisfactory.

- All products returned must be pre-approved and a Return Authorization Number (RA#) attached.
- Santech will issue a full refund only for Santech® products returned with a Return Authorization Number (RA#).
- Product returned to Santech without prior approval will be refused and returned freight collect.
- Each pallet or container must be clearly marked with the RA#.
- Product must be purchased from Santech.
- Some products purchased may not be eligible for return. These non-return products include but are not limited to: chemicals, special ordered products or products that are obsolete or superseded.
- Products returned as new should be in its original packaging, clean, and in saleable condition. If repackaging is required, an additional 25% restocking fee will be charged.
- The RA needs to be requested within 30 days, and the product must be returned within 60 days after receipt.
- Customers account must be current before Santech will accept any allowable return.
- Product may not be returned in lieu of payment.
- Do not deduct any new or warranty credits from payments to be made to Santech until those credits are reflected on a monthly statement.
- Failure to do this may lead to an interruption on your account.

It is our goal at Santech to have a return policy that is beneficial to our customers and us. Changes in the market have forced us to invoke a strict return policy. Our return policy is designed to be easy, quick, and effective. Failure to comply with the above guidelines may result in at least 25% restocking fee. Please read and follow the policy above.

## Warranty Policy

### WARRANTY POLICY:

All goods sold hereunder are warranted to be free from defects in material and workmanship and/or conform to applicable specifications, drawings, or blueprints unless otherwise stated. Some items have “no warranty” and will be noted on part description. **THESE EXPRESS WARRANTIES ARE IN LIEU OF AND EXCLUDE ALL OTHER WARRANTIES OR REPRESENTATIONS, EXPRESSED OR IMPLIED BY ANY LITERATURE, DATA, OR PERSON.** Sellers sole obligation under these warranties shall be to credit or replace any item or part manufactured by Seller and which is proved to be other than as warranted.

Seller shall have the sole right to determine whether such parts shall be repaired or replaced or whether credit shall be issued. No allowance shall be made for any labor charges of Buyer for inspection, installation, or tear down for replacement of parts, adjustments, or repairs. In no event shall Seller be made liable for collateral, consequential, or contingent damages. Our products are not warranted for any time period, any measure of service, or any specific purpose.

If goods are claimed to be other than as warranted, Seller, upon notice promptly given, will either examine the goods at their site or issue shipping instructions for return to Seller (transportation cost paid by Buyer), and if any goods are proved to be other than as warranted, transportation costs (by least expensive method) to and from Seller’s plant will be borne by Seller and reimbursement or credit will be made for amounts so expended by Buyer.

Every such claim for breach of the warranties herein contained shall be deemed to be waived by the Buyer unless made in writing within ninety (90) days from the date of shipment of the goods to which claim relates. These warranties shall not extend to any goods or parts thereof which have been subject to abuse or neglect, damage by accident, rendered defective by reason of improper installation, or used for other than the express purpose for which it was designed and built. These warranties shall not apply to any goods or parts made from tools, materials, or parts furnished by the Buyer or acquired from others at his request and/or to his specification.

# *Santech*®

World Class Excellence in  
Engineered Replacement Parts™

***Distributed By:***



Santech Industries, LLC

1401 Valley View Lane, Suite 100, Irving, TX 75061

Phone: (817) 589-1212 1-800-803-9069

E-Mail: [sales1@santech.com](mailto:sales1@santech.com) - Web: <http://www.santech.com>

**Innovation Driving Technology - Service - Engineered Replacement Components**

